

worksurfaces & countertops

PRODUCT MAP	136
WORKSURFACE BASICS	139
WORKSURFACE ACCESSORY BASICS	140
EDGE TRIM STYLE OVERVIEW	141
PRODUCT LISTING	142

product map

T W R R Rectangular Worksurface

Page 142
Depth: 24" & 30" / Widths: 24" - 72"

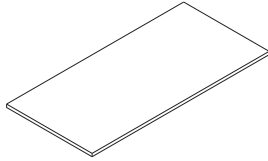

T W S T Straight Transition Worksurface

Page 144
Depth A: 24" & 30" / Width: 36" - 72" /
Depth B: 30" & 36"

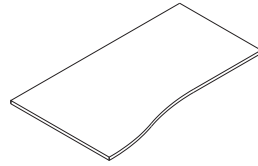

T W O R Outside Radius Worksurface

Page 146
Depth: 24" & 30" / Width: 36" - 72"

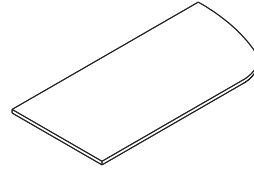

T W S C Standard Corner Worksurface

Page 148
Depth: 19" & 30" / Width: 36" - 48"

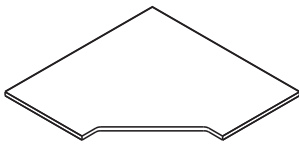

T W S R Standard Radius Corner Worksurface

Page 149
Depth: 24" & 30" / Width: 36" - 48"

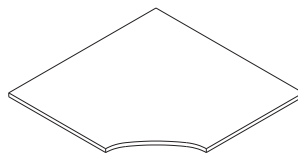

T W R X Split Radius Corner Worksurface with Keyboard Support

Page 150
Depth: 24" & 30" / Width: 42" & 48"

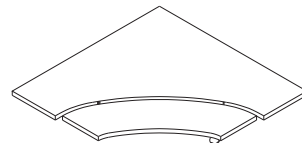

T W C X Split Corner Worksurface with Keyboard Support

Page 151
Depth: 24" & 30" / Width: 42" & 48"

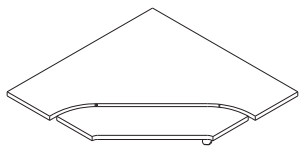

T W C R Radius Corner Worksurface with Return

Page 152
Depth A: 24" & 30" / Width A: 36" - 48" /
Width B: 48" - 72"

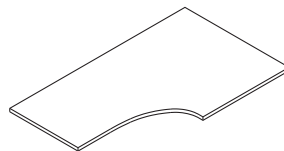

T W E S EDP Worksurface

Page 154
Depth A: 19" & 24" / Width: 24" - 72" /
Depth B: 24" & 30"

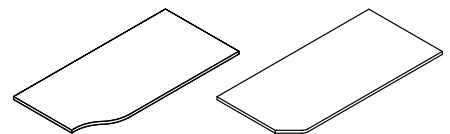

T W B S Bullet Top Worksurface

Page 155
Depth: 24" - 36" / Width: 48" - 72"

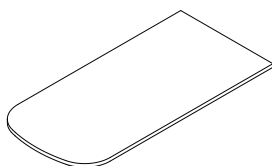

T W P S P-Top Worksurface

Page 156
Depth: 24" - 36" / Width: 60" - 72"

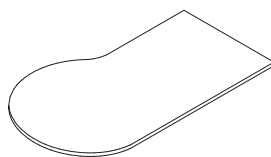

T W M P Modified P-Top Worksurface

Page 157
Depth: 24" & 30" / Width: 36" - 72"

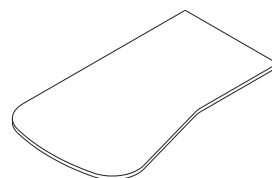

T W D T D-Top Worksurface

Page 158
Depth: 24" & 30" / Width: 52" & 64"

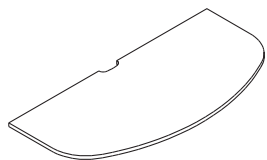

T X T A Tapered Worksurface

Page 159
Depth A: 24" & 30" / Width: 36" - 72" /
Depth B: 30" & 36"

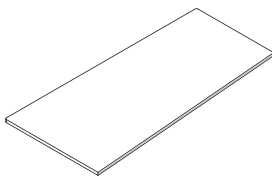

T X S C Standard Corner Worksurface (xm)

Page 160
Depth: 24" & 30" / Width: 36" - 48"

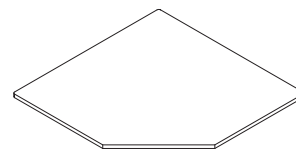

T X C R Radius Corner Worksurface with Return (xm)

Page 161
Depth A: 24" & 30" / Depth B: 24" & 30" /
Width A: 48" / Width B: 60" - 72"

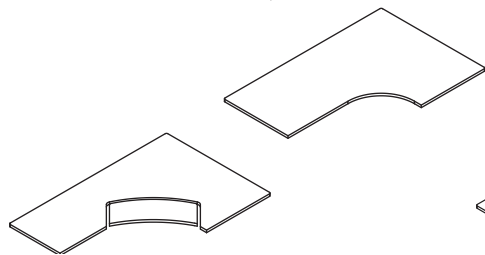

T X G C Guest Corner Worksurface

Page 162
Depth: 15" & 24" / Width A: 36" - 48" /
Width B: 60" - 72"

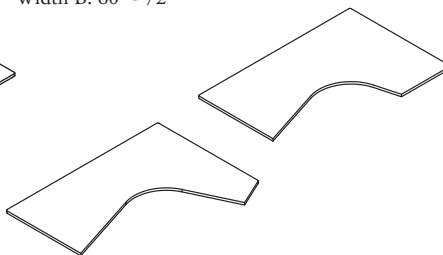

T X F L Flask Worksurface

Page 163
Depth A: 24" & 30" / Depth B: 34" & 40" /
Width A: 24" & 30" / Width B: 60" - 72"

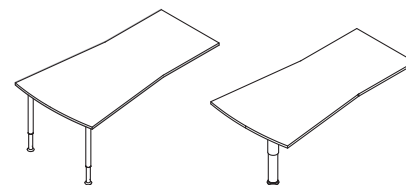

T W C S Straight Countertop

Page 164
Width: 18" - 72" / Depth: 15"

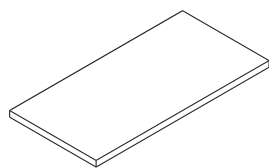

T W C B Bullet Countertop

Page 165
Width: 18" - 72" / Depth: 15"

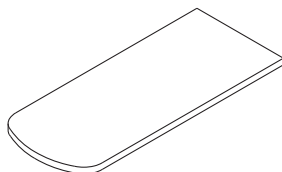

T W C D Double Bullet Countertop

Page 166
Width: 18" - 72" / Depth: 15"

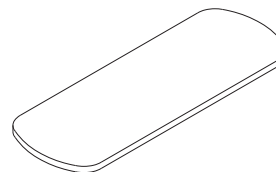

T W C A Angled Countertop

Page 167
Width: 18" - 72" / Depth: 15"

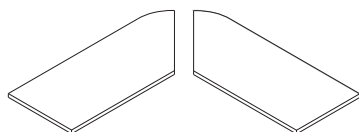

Transit worksurfaces may be panel-mounted, semi-suspended or freestanding and are available in a variety of shapes and finishes.

- Worksurfaces include a 1" wire management gap, and are equipped with inserts that allow for panel-mounted supports or freestanding applications
- The Transit xm worksurface collection may be used in panel-mounted applications only
- Transit worksurfaces may be mounted on-module to Altos walls
- Worksurfaces may not span more than 60" without additional support. Supports are ordered separately unless otherwise indicated

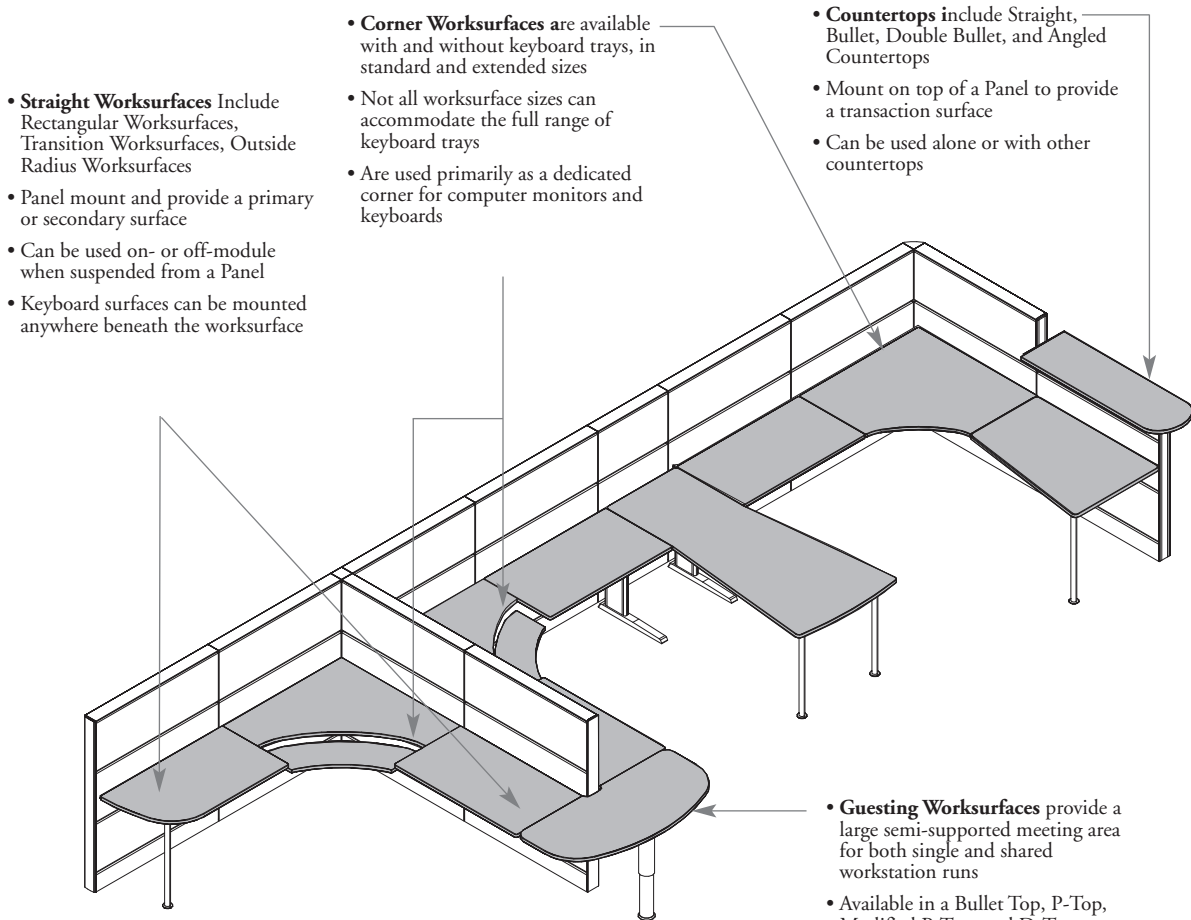

- **Straight Worksurfaces** Include Rectangular Worksurfaces, Transition Worksurfaces, Outside Radius Worksurfaces
- Panel mount and provide a primary or secondary surface
- Can be used on- or off-module when suspended from a Panel
- Keyboard surfaces can be mounted anywhere beneath the worksurface

- **Corner Worksurfaces** are available with and without keyboard trays, in standard and extended sizes
- Not all worksurface sizes can accommodate the full range of keyboard trays
- Are used primarily as a dedicated corner for computer monitors and keyboards

- **Countertops** include Straight, Bullet, Double Bullet, and Angled Countertops
- Mount on top of a Panel to provide a transaction surface
- Can be used alone or with other countertops

- **Guesting Worksurfaces** provide a large semi-supported meeting area for both single and shared workstation runs
- Available in a Bullet Top, P-Top, Modified P-Top, and D-Top Worksurface

- **Seamless Finish Worksurfaces** greater than 48" in width will be accompanied by an adjustable support beam
- Support beam can be fitted to the left or right when applying pedestal storage underneath
- Accept Keyboard Trays and Accessories

- With a support beam must include a Spacer Bracket. Please see Complements: *Teknion's Ergonomics & Accessories Program*
- With a support beam will not accept Pelican Drawers (DPD21, DPD61)
- Will not accept Stretch Pedestals or Two-High Laterals with worksurfaces greater than 48" in width

Finishes

- Worksurfaces are available in Foundation Laminate, Flintwood, and Seamless colors
- Edge trim styles include Flat and Bullnose, Seamless Knife, Seamless Flat and Seamless Eased
- Flintwood edge trims and Seamless edge trims will be finished to match the surface
- Supports, when included are available in Foundation, Mica and Accent colors

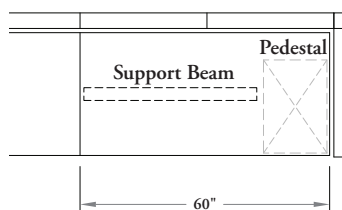
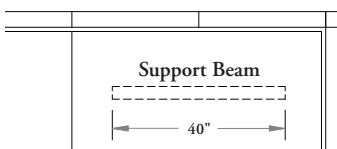

worksurface accessory basics

Accessories can be added to Transit Worksurfaces to provide extra storage, wire management and privacy.

! Accessories must be ordered separately

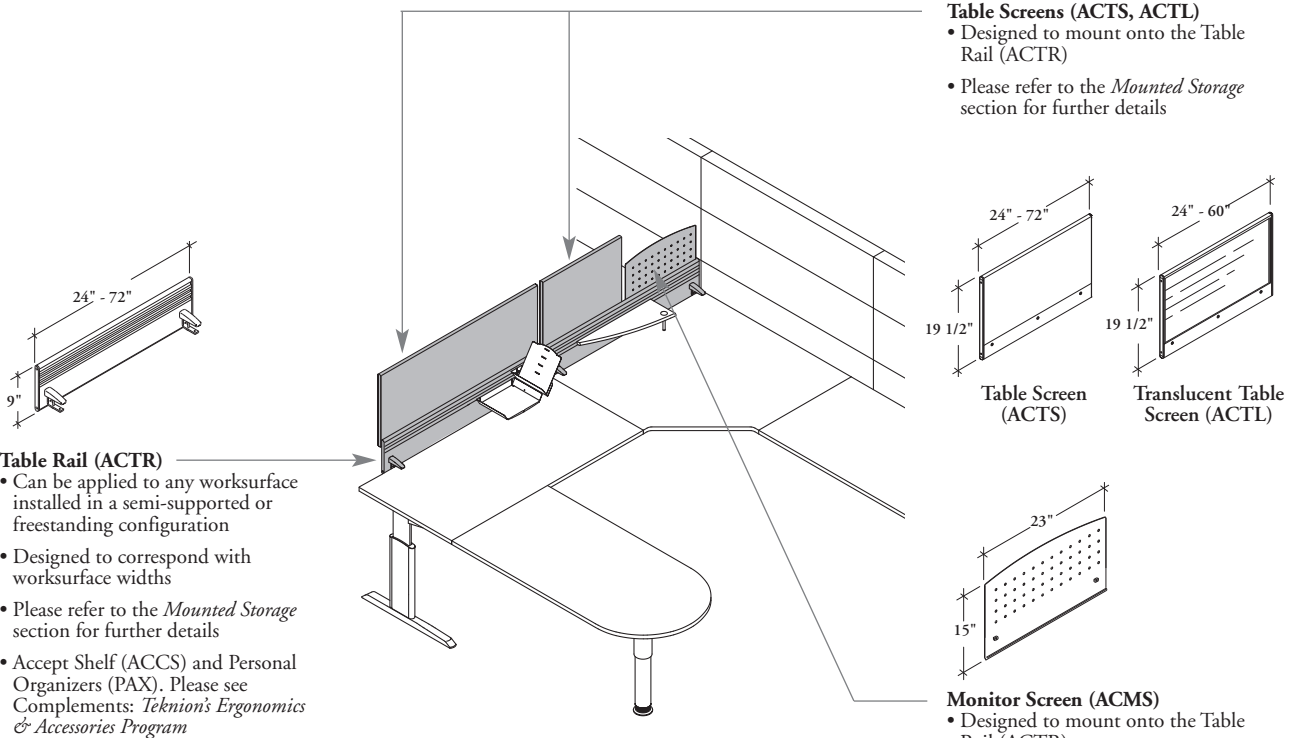

I40

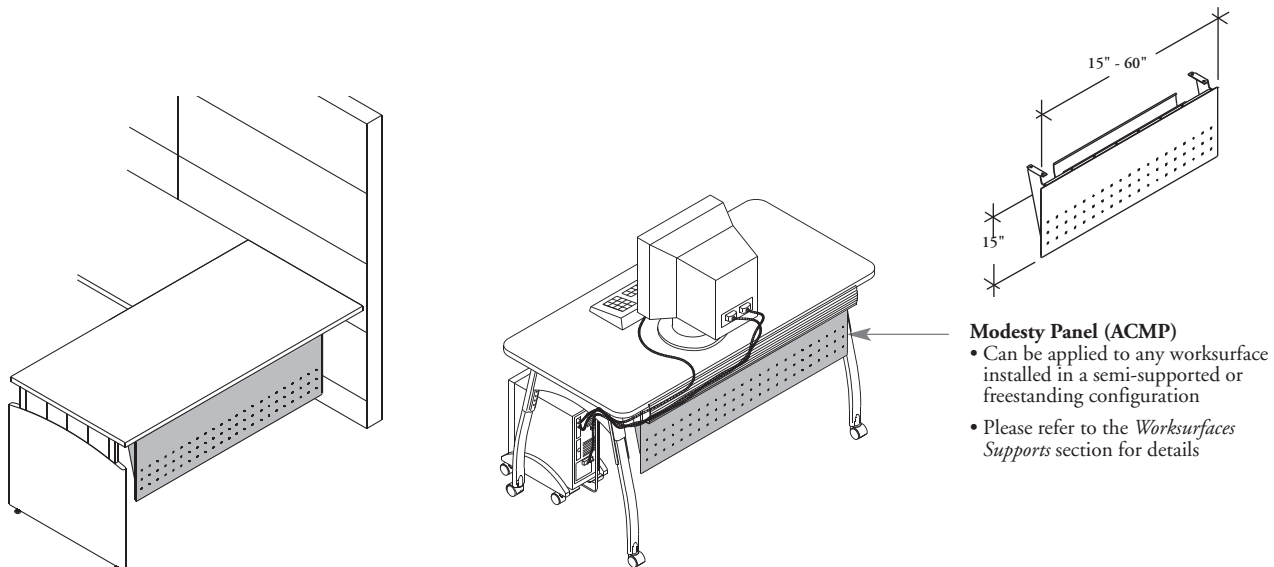





worksurface & countertops

edge trim style overview

The chart below indicates which edge trim style can be specified with all Transit Worksurface finishes.

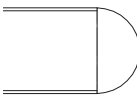
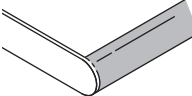
❗ Shading indicates user edge

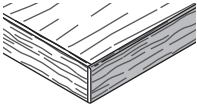
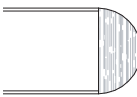
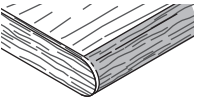
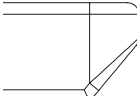
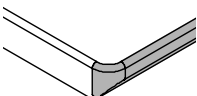
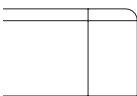
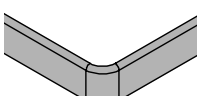
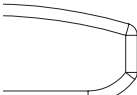
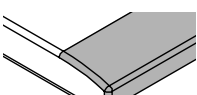
		Foundation Laminate Surface	Seamless Color Surface	Flintwood Surface	Non-User Edge
Flat (8) All Edges			n/a	n/a	Flat (8)
Bullnose (2) User Edge Only			n/a	n/a	Finished in a coordinating PVC flat trim
Flintwood * Flat (9) User Edge Only		n/a	n/a		See legend below
Flintwood * Bullnose (3) User Edge Only		n/a	n/a		See legend below
Seamless Knife (K) User Edge Only		n/a		n/a	Finished in a coordinating flat trim
Seamless Flat (G) All Edges		n/a		n/a	Seamless Flat (G)
Seamless Eased (E) User Edge Only		n/a		n/a	Finished in a coordinating flat trim

* If Flintwood Trim is specified with a Foundation Laminate Surface, a coordinating PVC Flat Trim is applied to the non-user edges, with the exception of Pecan Flintwood Trim. A coordinating Flintwood Flat Trim is applied when Pecan Trim is specified.

The coordinating Flintwood/PVC Edge Trim Color combinations are:

1. Flintwood Flax/PVC Maple Tone
2. Flintwood Sable/PVC Black
3. Flintwood Chianti/PVC Mahogany Tone
4. Flintwood Red Cherry/PVC Cherry
5. Flintwood Pecan/PVC Pecan Flintwood
6. Flintwood Sycamore/PVC Italian Yew Tone
7. Flintwood Medium Sycamore/PVC Mahogany
8. Flintwood Dark Walnut/PVC Black
9. Flintwood Black Walnut/PVC Black