

ability tables

PRODUCT MAP	223
WORK TABLE BASICS	224
WORK TABLE EDGE TRIM STYLE OVERVIEW	225
PARTNER TABLE BASICS	226
PARTNER TABLE EDGE TRIM STYLE OVERVIEW	227
DESK-MOUNTED TABLE ACCESSORY BASICS	228
PRODUCT LISTING	230

A W R E Rectangular Table

Page 230
Depth: 24", 30 & 36" / Width: 48" – 72"

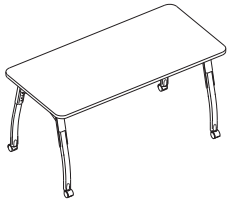

A W R A Racetrack Table

Page 232
Depth: 24", 30" & 36" / Width: 48" – 72"

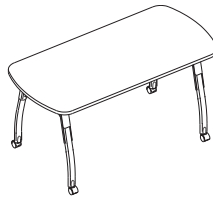

A P H O Hoola

Page 234
Diameter: 36" & 42"

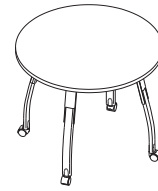

A P B L Blink

Page 235
Depth: 24" & 30" / Width: 36" & 42"



A P D E Dew

Page 236
Depth: 24" & 30" / Width: 36" & 42"

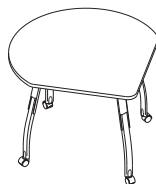

A C T T Table Tray

Page 237
Width: 12" – 72"

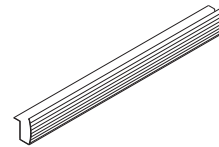

A C M P Modesty Panel

Page 238
Width: 15" – 60" / Height: 15"

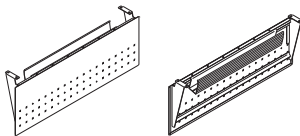

work table basics

Work Tables are multi-purpose mobile tables that can be moved easily within and between open plan and systems environments.

- Ability Work Tables are functionally and aesthetically compatible with T/O/S, Transit and Leverage systems
- Work Table surfaces are 1" thick and are available in a selection of Flintwood stains and Foundation and colors with four edge trim styles, Bullnose, Flat, Flintwood Bullnose and Flintwood Flat
- Two dual leg supports are the standard surface support for all Work Tables and are available in Foundation and Mica colors
- Can be ordered with casters, levelers, or lockable casters (two back casters will be lockable, if lockable casters are specified). Casters and levelers are Black
- A Table Tray can be ordered as part of all Work Tables, excluding the Bean Table (AWBE), or it can be ordered as a separate product. The Table Tray is Black
- All dimensions and dimension codes are nominal

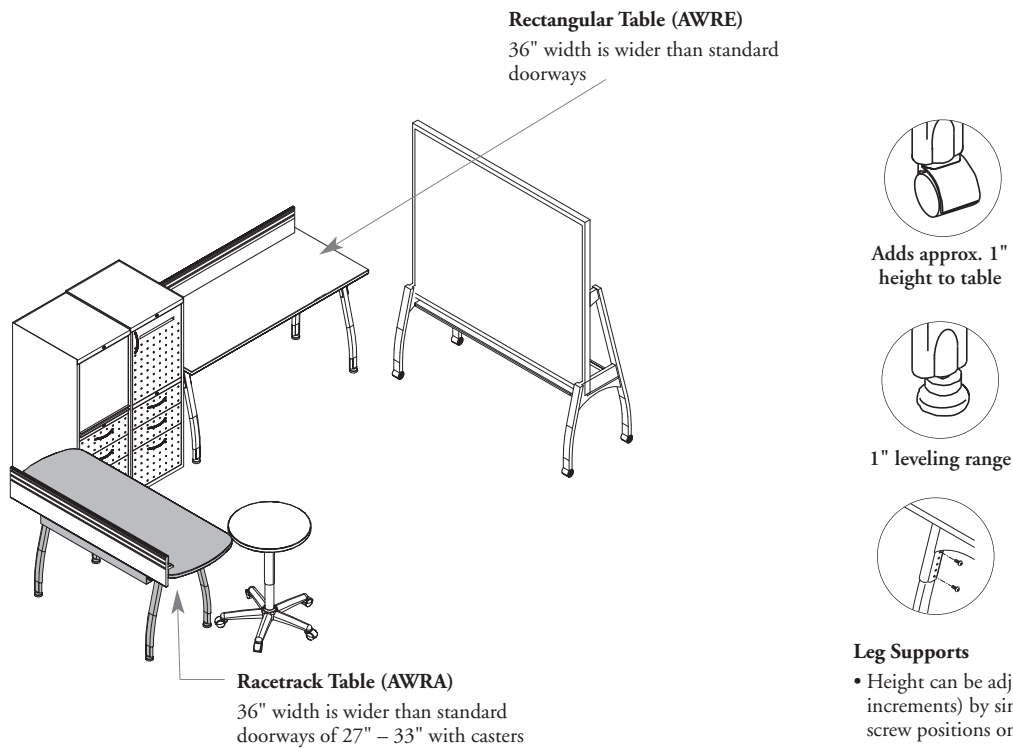



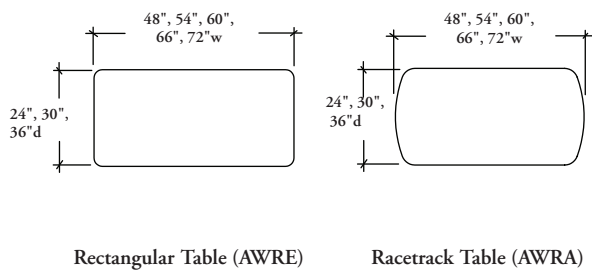

224

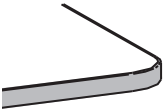
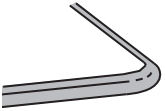

work table edge trim style overview

The chart below indicates which edge trim style can be specified with all Ability table surface finishes.

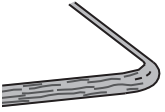
⚠ Shading indicates user edge

	Foundation Laminate Surface	Flintwood Surface
Flat (8) All Edges		n/a
Bullnose (2) All Edges		n/a
Flintwood Flat (9) All Edges		
Flintwood Bullnose (3) All Edges		

partner table basics

Partner Tables are collaborative mobile tables that can be moved easily within and between open plan and systems environments providing a surface to accommodate up to four guests.

- Ability Partner Tables are functionally and aesthetically compatible with T/O/S, Transit and Leverage systems
- Four single leg supports are the standard surface support for all Partner Tables and are available in Foundation and Mica colors
- Surfaces are 1" thick and are available in a selection of Flintwood stains and Foundation colors with four edge trim styles, Bullnose, Flat, Flintwood Bullnose and Flintwood Flat
- Can be ordered with casters, levelers, or lockable casters. When lockable casters are specified, all four casters will be lockable. Casters and levelers are Black
- Partner Tables do **not** accept Table Accessories
- Partner Tables are wider than standard doorways; therefore, they **cannot** be rolled through doorways
- All dimensions and dimension codes are nominal

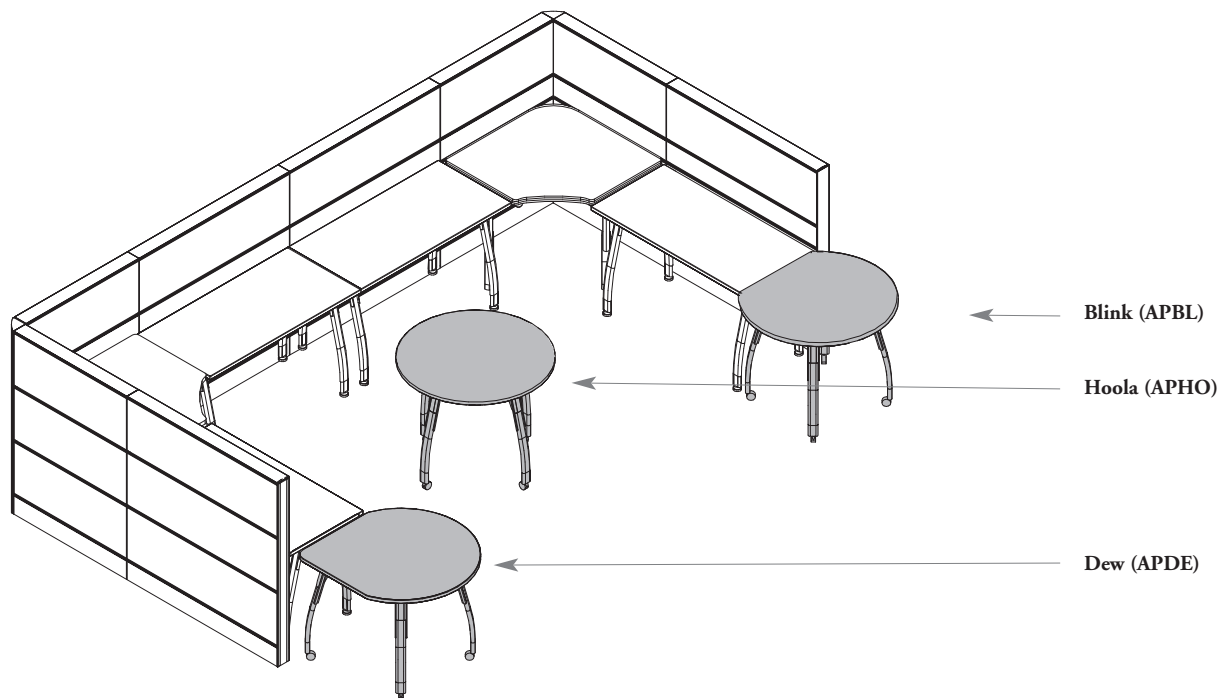

Leg Supports

- Height can be adjusted, (in 1" increments) by simply adjusting the screw positions on each leg
- Height adjustment range of 26" – 32" with levelers
- Height adjustment range of 27" – 33" with casters

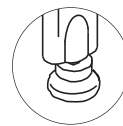
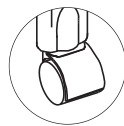
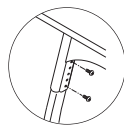

Adds approx. 1" height to table

1" leveling range

Surface Shape Options

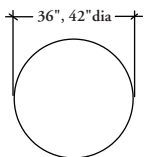

Hoola (APHO)

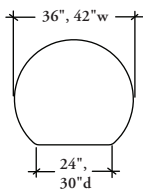

Blink (APBL)

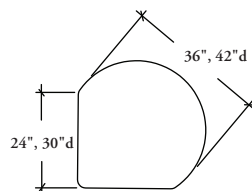

Dew (APDE)

partner table edge trim style overview

The chart below indicates which edge trim style can be specified with all Ability table surface finishes.

⚠ Shading indicates user edge

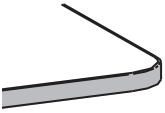
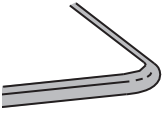
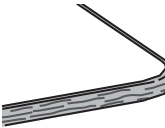
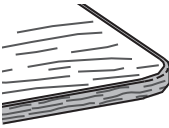
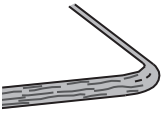
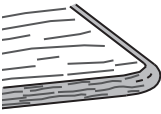
	Foundation Laminate Surface	Flintwood Surface
Flat (8) All Edges		n/a
Bullnose (2) All Edges		n/a
Flintwood Flat (9) All Edges		
Flintwood Bullnose (3) All Edges		

desk-mounted table accessory basics

Ability offers desk-mounted accessories to enhance workspace organization.

! All dimensions and dimension codes are nominal

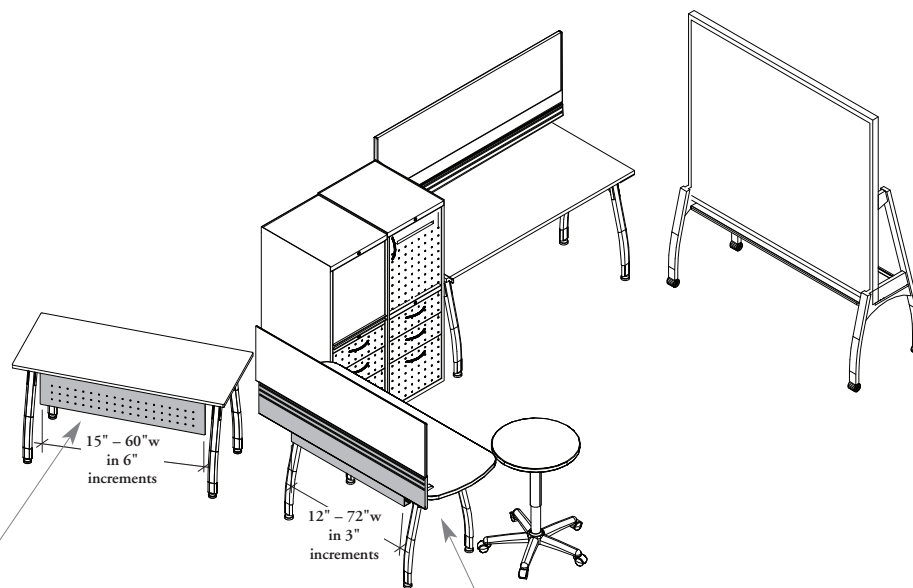

Modesty Panel (ACMP)

- Provides non-tackable seated privacy at Ability Tables
- Mounts beneath the surface between the rear legs
- Should be positioned 7 1/2" from the edge of the surface for adequate knee space
- Can be applied in conjunction with table accessories such as Table Rail (ACTR) and Table Tray (ACTT)
- A 1" **wire management gap** at the top allows cables to be brought to worksurface level
- Modesty Panel widths differ depending on the size and shape of the table to which is it being applied
- Available in Foundation and Mica colors

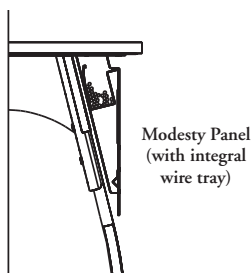

Table Tray (ACTT)

- Attaches to the underside of a table and is intended for routing wires externally from a panel environment to the table or from table-to-table
- **Not** intended for the routing of extension cords
- Can be used only on straight edges
- **Not** visible above the worksurface
- Can be ordered as part of the table or separately
- **Cannot** be used on the Bean Table
- Tray widths differ depending on the size and shape of the table to which is it being applied. See chart on the following pages
- If a Table Tray (ACTT) is being applied to the same surface as the Table Rail (ACTR), the Table Tray width must be at least 12" (nominal) less than the Table Rail width in order to clear the Table Rail clamps
- Finished in Black