

# ability screens

MOBILE & EXPANDABLE SCREEN OVERVIEW . . . . .	163
MOBILE & EXPANDABLE SCREEN BASICS . . . . .	164
PLANNING WITH EXPANDABLE SCREENS . . . . .	165



# mobile & expandable screen overview

## mobile screens

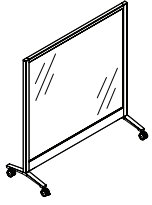

**Mobile Translucent Screen (ACMSNA)**  
Available in widths of 36", 42" and 48"

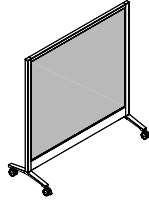

**Mobile Whiteboard/ Whiteboard Screen (ACMSNB)**  
Available in widths of 36", 42" and 48"

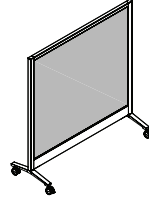

**Mobile Whiteboard/ Fabric Screen (ACMSNC)**  
Available in widths of 36", 42" and 48"

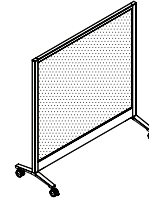

**Mobile Fabric/Fabric Screen (ACMSND)**  
Available in widths of 36", 42", 48" and 60"

## expandable screens

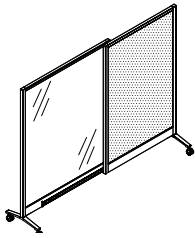

**Expandable Screen Fixed Translucent/Sliding Fabric (ACEB)**  
Available in 72" width

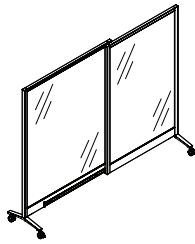

**Expandable Screen Fixed Translucent/Sliding Translucent (ACED)**  
Available in 72" width

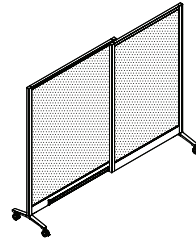

**Expandable Screen Fixed Fabric/Sliding Fabric (ACEG)**  
Available in 72" width

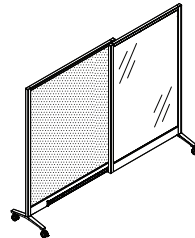

**Expandable Screen Fixed Fabric/Sliding Translucent (ACEH)**  
Available in 72" width

## mobile & expandable screen basics

The Ability collection of mobile screens and expandable screens are designed to integrate with Teknion's broad product portfolio to provide utility, privacy and space division through the workplace.

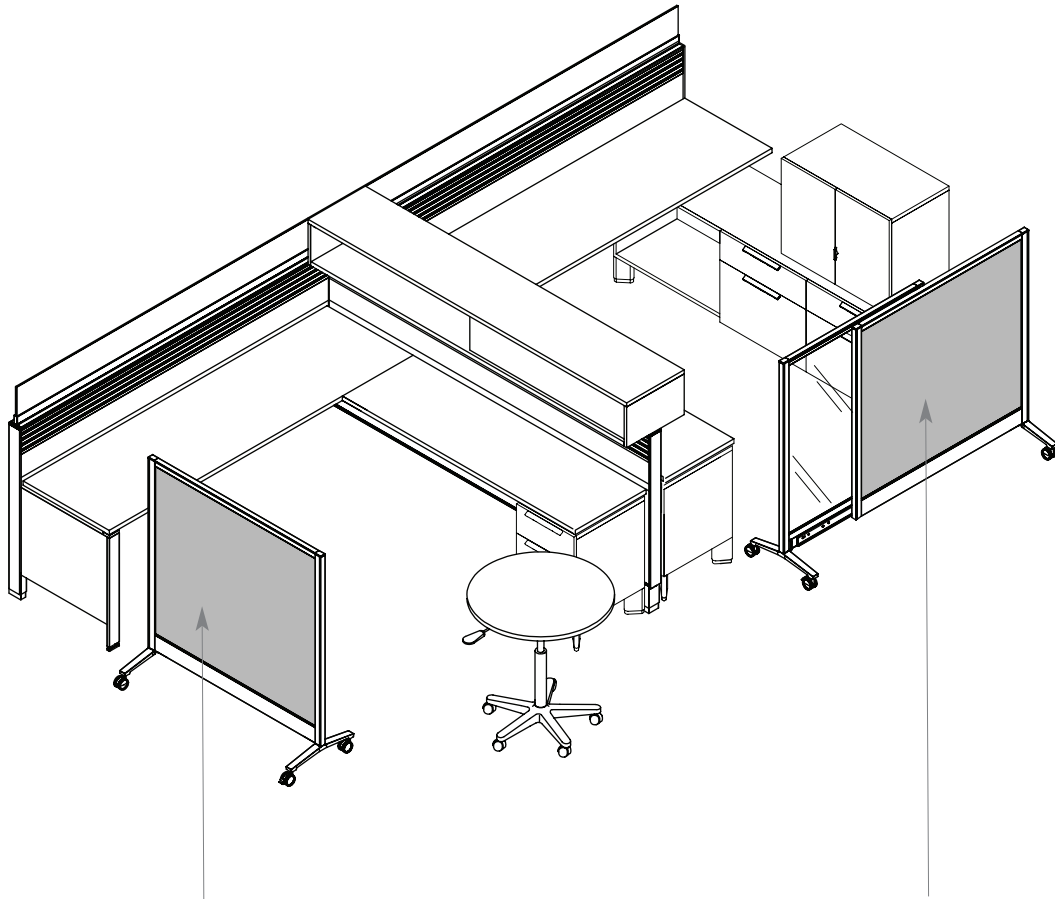

### Mobile Screen (ACMSN\_)

- Provides a large scale boundary partition with a variety of finish options including translucent, whiteboard and fabric
- Available with casters or glides
- Whiteboard option includes one tray for markers
- Heights include 51", 66" and 72" and widths include 36", 42", 48" and 60" width depending on finish
- Dual sided fabric screens are tackable but when whiteboard is on the backside, the fabric is **not** tackable
- Fabric is applied "off the bolt", see *Fabrics and Finish Program* guide for more information
- The maximum width for whiteboards and translucent screen is 48" width

### Expandable Screen (ACE\_)

- Provides a mobile freestanding large scale partition with a combination of functional and aesthetic surfaces including, fabric and translucent
- Is expandable to provide visual and territorial privacy and provides a "door" solution for workstations and casual break out and lounge environments
- All options available in heights of 51" and 66"
- Available in 72" width (two 36" sections)
- Fabric is applied "off the bolt", see *Fabrics and Finish Program* guide for more information
- The sliding portion is always 36" width
- Expandable screens are handed

# planning with expandable screens

The following should be considered when planning with mobile and expandable screens.

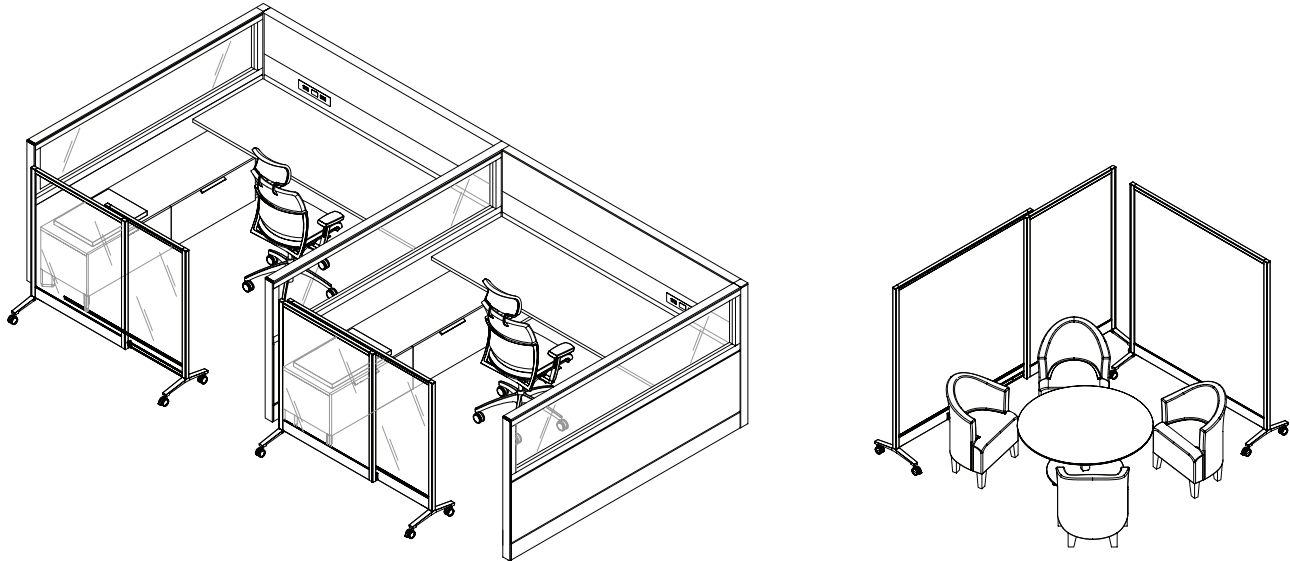

Mobile and expandable screens can be used individually or in combination with other screens to provide large scale partitions and privacy in both workstation areas and shared spaces.

### Expandable Screen (ACE)

- Expandable screens consist of a fixed section and an sliding section
- The fixed section and sliding section are both 36" wide

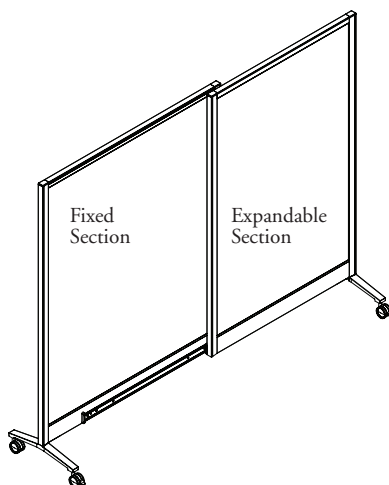

Right Hand

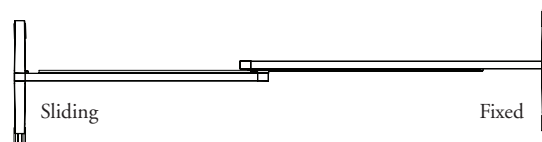

or

Left Hand

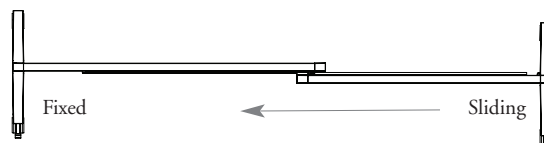

- Expandable screens are handed
- The handedness is determined by the direction that the sliding screen slides, when the sliding screen rests on top of the fixed screen