

# point long island

## features

A modern classic, Point Long Island's silhouette features straight shapes with thin lines that define this modular lounge seating collection. Offered through a partnership with Point Outdoor in Alicante, Spain, Long Island is designed by Christophe Pillet and a timeless classic you will never suspect can be used outdoors. Pillet's goal was to "make it as desirable and as well finished as a piece of indoor furniture with a similarly detailed design."

Eminently versatile, Point Long Island adds a universal elegance to any indoor or outdoor lounge environment. Featuring a lounge chair, settee, sofa, and sectional components, Long Island's deep seating and thick cushions encourages a relaxed mood that offer comfort and support. The frame and seating cushions can be upholstered in contrasting textiles that will take on additional personality over time as they develop comfort wrinkles.

When specified for use in outdoor environments, Long Island includes water barriers for cushions and a wide choice of textile patterns and colorways specifically designed for UV resistance and durability and to withstand the weather's elements. Point Long Island will become your new classic in indoor and outdoor environments.

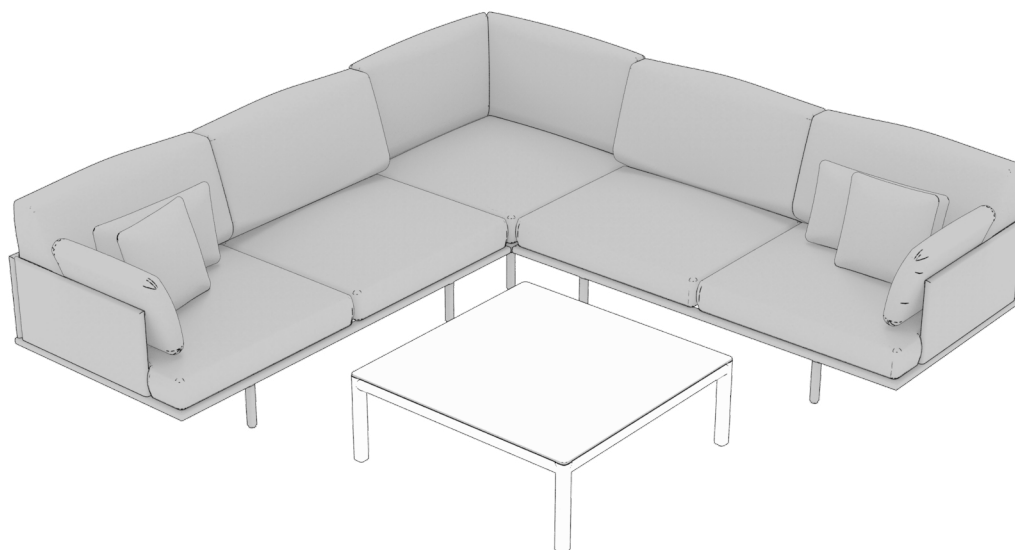

dimensions

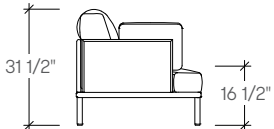
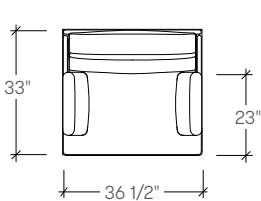

Point Long Island  
Lounge Chair  
(PNLCP1A / PNLCW1A)

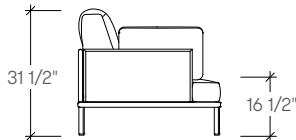
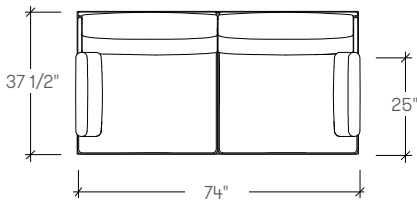

Point Long Island Two Seat  
Settee  
(PNLSP2A / PNLSW2A)

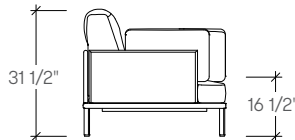
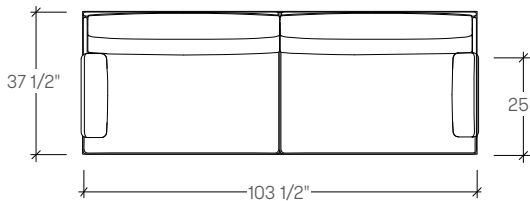

Point Long Island Three  
Seat Sofa  
(PNLSP3A / PNLSW3A)

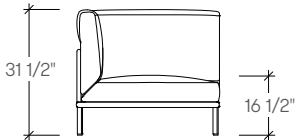
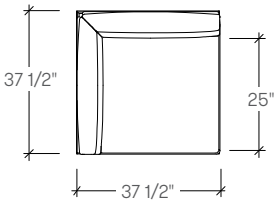

Point Long Island  
Corner Chair Sectional  
(PNLLP1C / PNLLW1C)

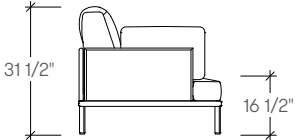
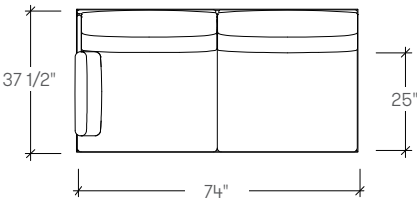

Point Long Island Two Seat  
Sectional with One Arm,  
Left or Right Facing  
(PNLLP2L / PNLLW2L)  
(PNLLP2R / PNLLW2R)

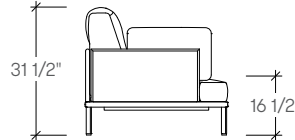
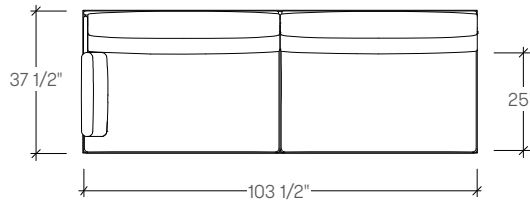

Point Long Island Three  
Seat Sectional with One  
Arm, Left or Right Facing  
(PNLLP3L / PNLLW3L)  
(PNLLP3R / PNLLW3R)

# point long island

## planning

Point Long Island is eminently versatile and includes a lounge chair, settee, sofa, and sectional components that configure for long runs and L shaped configurations. Long Island deep seating encourages a relaxed mood and thick cushions that offer comfort and support. The frame and seating cushions can be upholstered in contrasting textiles and will take on additional personality over time as they develop comfort wrinkles. Thin occasional tables round out the functionality of this line.

### indoor environment applications

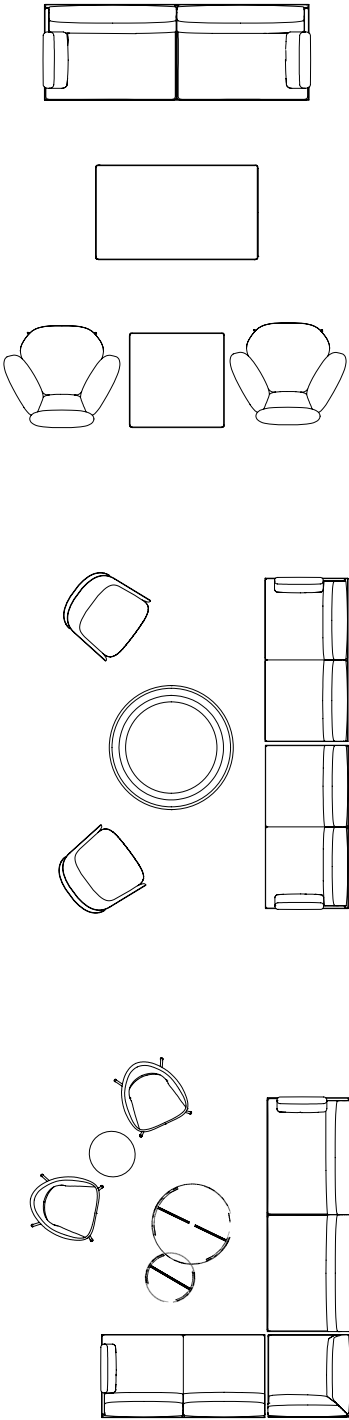

### outdoor environment applications

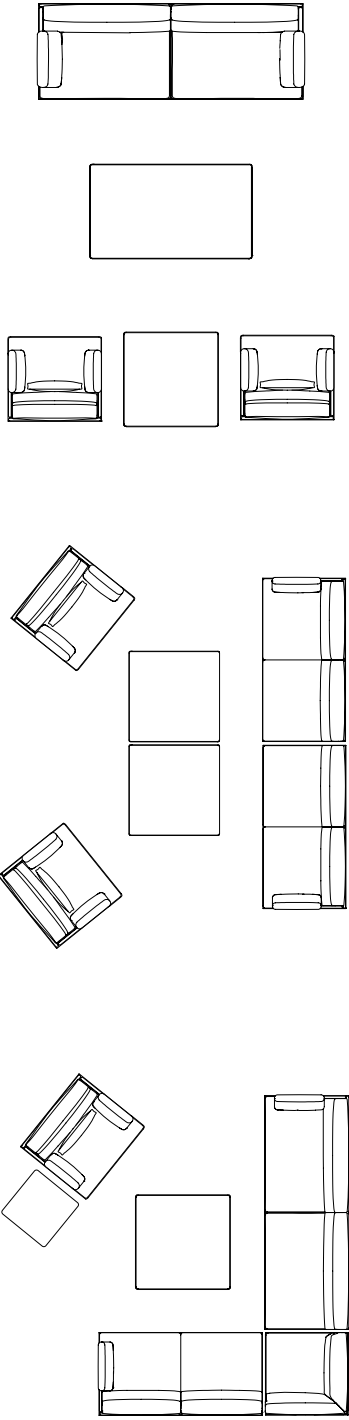

## specifying point long island finishes

Point Long Island is available in a wide range of fabric combinations that allow for an expressive use of textile color and texture.

### Note:

Point Long Island seating specified for use in an outdoor environment include water barrier covers and are only available in textiles approved for use in an outdoor environment. Seating specified for use in an indoor environment include outdoor textiles as an option but do not include water barriers. Indoor seating should never be used outdoors and will not be covered under the Studio TK warranty.

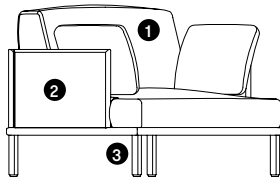

### PNLCP1A (indoor use)

- 1 **Seat Upholstery Finish**  
Select seat upholstery
- 2 **Frame Upholstery Finish**  
Select frame upholstery
- 3 **Leg Finish**  
Select leg paint finish

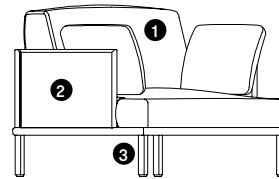

### PNLCW1A (outdoor use)

- 1 **Seat Upholstery Finish**  
Select seat upholstery
- 2 **Frame Upholstery Finish**  
Select frame upholstery
- 3 **Leg Finish**  
Select leg paint finish

## comfort wrinkles

Upholstered sections feature large and/or long panels that will take on additional personality over time as they develop comfort wrinkles from use.

## specification example

Point Long Island lounge seating is available in several seating configurations for use in an indoor or an outdoor environment. Product specified for an indoor environment may not be used outdoors.

Arm placement is determined by standing in front of a seat. A "Left Facing" arm is to your left when looking at the seat and to your right when sitting in the seat.

### Steps involved in specifying Point Long Island

- Select the model for indoor or outdoor use
- Select the seat configuration
- Select the seat cushion upholstery
- Select the frame upholstery
- Select the leg finish

### Example:

**PNLCW**  
PNLCW1A  
PNLCW1AE523  
PNLCW1AE523E523  
PNLCW1AE523E523QG

## weights

Point Long Island Lounge Chair	64 lbs
Point Long Island Two Seat Settee	115 lbs
Point Long Island Three Seat Sofa	184 lbs
Point Long Island Corner Chair Sectional	66 lbs
Point Long Island Two Seat Sectional with One Arm	110 lbs
Point Long Island Three Seat Sectional with One Arm	178 lbs

## indoor vs outdoor seating construction

Point Long Island lounge seating is available to specify for use in either an indoor or an outdoor environment and has unique model numbers. The overall appearance is the same, however, there are additional construction elements necessary for seating intended for use outdoors where it is exposed to the weather.

## cushion water barriers

When specified for use in an outdoor environment, Point Long Island features water barrier covers that are installed over cushions prior to the application of upholstery. These covers provide a protective barrier to prevent the foam from absorbing moisture. Seating specified for use in a protected indoor environment does not include water barriers on the cushions and may never be used outdoors.

**outdoor rated textiles**

Seating specified for use in an outdoor environment will be limited to order in finish textiles that are specifically designed to withstand prolonged UV exposure and outdoor elements. Seating ordered for use in indoor environments are available in a wider range of textiles that may include textiles also suitable for outdoor use. Note that the use of outdoor rated textiles alone does not approve seating for use in an outdoor environment.

**outdoor rated paint**

Point Long Island is constructed with aluminum frames finished in a textured paint formulated to withstand prolonged UV exposure and outdoor weather elements. All Point Long Island frames are finished in the same paint regardless of if they are specified for outdoor or indoor use. Point Long Island is not available in any of Studio TK's Fundamental or Fashion Paint finishes.

**outdoor covers**

Optional outdoor covers are available for added protection to the weather and dirt and debris that can build up. While it is not necessary to use covers in an outdoor environment, their use will reduce the cleaning required.

**outdoor bracket**

Secure your Point outdoor furniture with optional brackets available in a black finish. Each set includes two corner brackets designed to anchor two legs to the ground. Installation requires drilled holes and appropriate hardware, which needs to be supplied by your installer according to your specific installation needs.

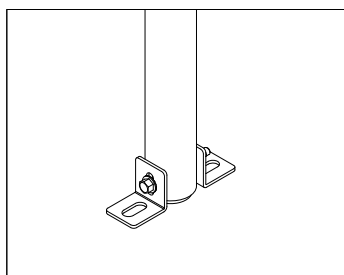

**special upholstery requirements**

The length of Point Long Island sofas requires components to be upholstered in a Railroad direction. Consideration should be given when selecting upholstery that features patterns or texture as they will present differently than other seating upholstered in the same pattern. Applied in an off the bolt direction.

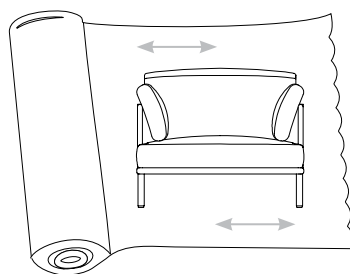

**COM/COL material requirement**

Yardage is based on a non-patterned fabric. Additional yardage may be required for pattern repeats and the matching required. Leather yield may be affected by the quality of the COL. However, variance in the size of the hides will not affect the yield.

<b>SINGLE UPHOLSTERY</b>		COM [yards]	COL [sq. ft.]
Point Long Island Lounge Chair	Seat Cushions	5 1/2	n/a
	Frame Upholstery	4	n/a
Point Long Island Two Seat Settee	Seat Cushions	9	n/a
	Frame Upholstery	4	n/a
Point Long Island Three Seat Sofa	Seat Cushions	11	n/a
	Frame Upholstery	5 1/2	n/a
Point Long Island Corner Chair Sectional	Seat Cushions	8	n/a
	Frame Upholstery	3	n/a
Point Long Island Two Seat Sectional with One Arm	Seat Cushions	9	n/a
	Frame Upholstery	4	n/a
Point Long Island Three Seat Sectional with One Arm	Seat Cushions	12	n/a
	Frame Upholstery	5 1/2	n/a

**PNLCP point long island lounge chair, indoor environment**

**Product Options**

Configuration	Seat Upholstery Finish	Frame Upholstery Finish	Leg Finish
1A Chair with Two Arms	Fabric	Fabric Leather	QG Gunmetal Grey QM Mineral White

**Note** Point Long Island is upholstered in a Railroad direction and consideration should be given when selecting textiles that feature patterns or texture  
 Indoor Lounge Chairs are never suitable for use in an outdoor environment and will void warranties. Choose the Outdoor Lounge Chair model when used outdoors  
 Point Long Island is only available in a Mineral White or Gunmetal Grey leg finish



		Seat												
		COM	COL	Gr.1	Gr.2	Gr.3	Gr.4	Gr.5	Gr.6	Gr.7	Gr.8	Gr.9	Gr.10	Gr.11
1A	Chair with Two Arms	4250	n/a	4505	4619	4718	4831	4916	4987	5058	5143	5228	5313	5413
												Leather		
		Gr.12	Gr.13	Gr.14	Gr.15	Gr.16	Gr.17	Gr.18	Gr.19	Gr.20	LB	LC	LD	
1A	Chair with Two Arms	5526	5668	5810	5951	6093	6235	6377	6518	6660	n/a	n/a	n/a	
		Frame												
		COM	COL	Gr.1	Gr.2	Gr.3	Gr.4	Gr.5	Gr.6	Gr.7	Gr.8	Gr.9	Gr.10	Gr.11
1A	Chair with Two Arms	0	n/a	255	369	468	581	666	737	808	893	978	1063	1163
												Leather		
		Gr.12	Gr.13	Gr.14	Gr.15	Gr.16	Gr.17	Gr.18	Gr.19	Gr.20	LB	LC	LD	
1A	Chair with Two Arms	1276	1418	1560	1701	1843	1985	2127	2268	2410	n/a	n/a	n/a	

## PNLSP point long island lounge sofa, indoor environment

### Product Options

Configuration	Seat Upholstery Finish	Frame Upholstery Finish	Leg Finish
<b>2A</b> Two Seat Settee with Two Arms	Fabric	Fabric	<b>QG</b> Gunmetal Grey
<b>3A</b> Three Seat Sofa with Two Arms		Leather	<b>QM</b> Mineral White

**Note** Point Long Island is upholstered in a Railroad direction and consideration should be given when selecting textiles that feature patterns or texture  
 Indoor Lounge Sofas are never suitable for use in an outdoor environment and will void warranties. Choose the Outdoor Lounge Sofa model when used outdoors  
 Point Long Island is only available in a Mineral White or Gunmetal Grey leg finish

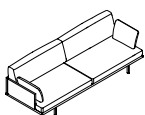
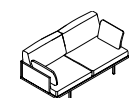

		Seat												
		COM	COL	Gr.1	Gr.2	Gr.3	Gr.4	Gr.5	Gr.6	Gr.7	Gr.8	Gr.9	Gr.10	Gr.11
<b>2A</b>	Two Seat Settee with Two Arms	7750	n/a	8214	8420	8601	8807	8962	9090	9219	9374	9529	9683	9864
<b>3A</b>	Three Seat Sofa with Two Arms	9900	n/a	10457	10704	10921	11168	11354	11509	11663	11849	12034	12220	12437
		Gr.12	Gr.13	Gr.14	Gr.15	Gr.16	Gr.17	Gr.18	Gr.19	Gr.20	Leather LB	LC	LD	
<b>2A</b>	Two Seat Settee with Two Arms	10070	10328	10586	10843	11101	11359	11617	11874	12132	n/a	n/a	n/a	
<b>3A</b>	Three Seat Sofa with Two Arms	12684	12993	13303	13612	13921	14231	14540	14849	15159	n/a	n/a	n/a	
		Frame												
		COM	COL	Gr.1	Gr.2	Gr.3	Gr.4	Gr.5	Gr.6	Gr.7	Gr.8	Gr.9	Gr.10	Gr.11
<b>2A</b>	Two Seat Settee with Two Arms	0	n/a	464	670	851	1057	1212	1340	1469	1624	1779	1933	2114
<b>3A</b>	Three Seat Sofa with Two Arms	0	n/a	557	804	1021	1268	1454	1609	1763	1949	2134	2320	2537
		Gr.12	Gr.13	Gr.14	Gr.15	Gr.16	Gr.17	Gr.18	Gr.19	Gr.20	Leather LB	LC	LD	
<b>2A</b>	Two Seat Settee with Two Arms	2320	2578	2836	3093	3351	3609	3867	4124	4382	n/a	n/a	n/a	
<b>3A</b>	Three Seat Sofa with Two Arms	2784	3093	3403	3712	4021	4331	4640	4949	5259	n/a	n/a	n/a	



## PNLLP point long island lounge sectional, indoor environment

### Product Options

Configuration	Seat Upholstery Finish	Frame Upholstery Finish	Leg Finish
<b>1C</b> Corner Chair Sectional	Fabric	Fabric	<b>QG</b> Gunmetal Grey
<b>2L</b> Two Seat Sectional with One Arm Left, Facing			<b>QM</b> Mineral White
<b>2R</b> Two Seat Sectional with One Arm Right, Facing			
<b>3L</b> Three Seat Sectional with One Arm Left, Facing			
<b>3R</b> Three Seat Sectional with One Arm Right, Facing			

**Note** Point Long Island is upholstered in a Railroad direction and consideration should be given when selecting textiles that feature patterns or texture  
 Indoor Lounge Sectional is never suitable for use in an outdoor environment and will void warranties. Choose the Outdoor Lounge Sectional model when used outdoors  
 Two seat Settee and three seat Sofa sectional components with one arm include a pair of ganging brackets to hold frames together when configured in an L shape or straight line  
 Point Long Island is only available in a Mineral White or Gunmetal Grey leg finish

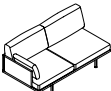
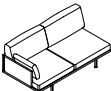
### Seat

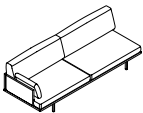
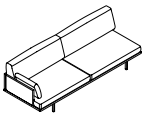
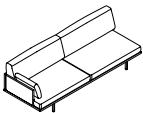
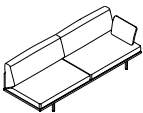
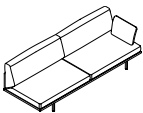
	COM	COL	Gr.1	Gr.2	Gr.3	Gr.4	Gr.5	Gr.6	Gr.7	Gr.8	Gr.9	Gr.10	Gr.11
 <b>1C</b> Corner Chair Sectional	4850	n/a	5221	5386	5531	5696	5819	5922	6052	6149	6273	6397	6541
 <b>2L</b> Two Seat Sectional with One Arm Left, Facing	7400	n/a	7818	8003	8166	8351	8490	8606	8722	8862	9001	9140	9302
 <b>2R</b> Two Seat Sectional with One Arm Right, Facing	7400	n/a	7818	8003	8166	8351	8490	8606	8722	8862	9001	9140	9302
 <b>3L</b> Three Seat Sectional with One Arm Left, Facing	9500	n/a	10010	10237	10436	10663	10833	10974	11116	11286	11457	11627	11825
 <b>3R</b> Three Seat Sectional with One Arm Right, Facing	9500	n/a	10010	10237	10436	10663	10833	10974	11116	11286	11457	11627	11825
	<b>Gr.12</b>	<b>Gr.13</b>	<b>Gr.14</b>	<b>Gr.15</b>	<b>Gr.16</b>	<b>Gr.17</b>	<b>Gr.18</b>	<b>Gr.19</b>	<b>Gr.20</b>	<b>Leather</b>			
										<b>LB</b>	<b>LC</b>	<b>LD</b>	
 <b>1C</b> Corner Chair Sectional	6706	6912	7118	7325	7531	7737	7943	8150	8356	n/a	n/a	n/a	
 <b>2L</b> Two Seat Sectional with One Arm Left, Facing	9488	9720	9952	10184	10416	10648	10880	11112	11344	n/a	n/a	n/a	
 <b>2R</b> Two Seat Sectional with One Arm Right, Facing	9488	9720	9952	10184	10416	10648	10880	11112	11344	n/a	n/a	n/a	
 <b>3L</b> Three Seat Sectional with One Arm Left, Facing	12052	12336	12619	12903	13186	13470	13753	14037	14320	n/a	n/a	n/a	
 <b>3R</b> Three Seat Sectional with One Arm Right, Facing	12052	12336	12619	12903	13186	13470	13753	14037	14320	n/a	n/a	n/a	

**PNLLP point long island lounge sectional, indoor environment (continued)**

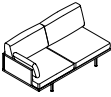
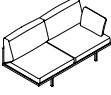
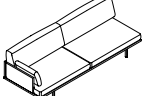
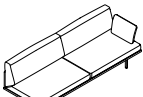
		Frame											Leather				
		COM	COL	Gr.1	Gr.2	Gr.3	Gr.4	Gr.5	Gr.6	Gr.7	Gr.8	Gr.9	Gr.10	Gr.11	LB	LC	LD
	1C Corner Chair Sectional	0	n/a	371	536	681	846	969	1072	1175	1299	1423	1547	1691			
	2L Two Seat Sectional with One Arm Left, Facing	0	n/a	418	603	766	951	1090	1206	1322	1462	1601	1740	1902			
	2R Two Seat Sectional with One Arm Right, Facing	0	n/a	418	603	766	951	1090	1206	1322	1462	1601	1740	1902			
	3L Three Seat Sectional with One Arm Left, Facing	0	n/a	510	737	936	1163	1333	1474	1616	1786	1957	2127	2325			
	3R Three Seat Sectional with One Arm Right, Facing	0	n/a	510	737	936	1163	1333	1474	1616	1786	1957	2127	2325			
		<b>Gr.12</b>	<b>Gr.13</b>	<b>Gr.14</b>	<b>Gr.15</b>	<b>Gr.16</b>	<b>Gr.17</b>	<b>Gr.18</b>	<b>Gr.19</b>	<b>Gr.20</b>							
	1C Corner Chair Sectional	1856	2062	2268	2475	2681	2887	3093	3300	3506		n/a	n/a	n/a			
	2L Two Seat Sectional with One Arm Left, Facing	2088	2320	2552	2784	3016	3248	3480	3712	3944		n/a	n/a	n/a			
	2R Two Seat Sectional with One Arm Right, Facing	2088	2320	2552	2784	3016	3248	3480	3712	3944		n/a	n/a	n/a			
	3L Three Seat Sectional with One Arm Left, Facing	2552	2836	3119	3403	3686	3970	4253	4537	4820		n/a	n/a	n/a			
	3R Three Seat Sectional with One Arm Right, Facing	2552	2836	3119	3403	3686	3970	4253	4537	4820		n/a	n/a	n/a			

## PNLCW point long island lounge chair, outdoor environment

### Product Options

Configuration	Outdoor Seat Upholstery	Outdoor Frame Upholstery	Leg Finish
1A Chair with Two Arms	Fabric	Fabric	<b>QG</b> Gunmetal Grey <b>QM</b> Mineral White

**Note** Point Long Island is upholstered in a Railroad direction and consideration should be given when selecting textiles that feature patterns or texture  
 Point Long Island is only available in a Mineral White or Gunmetal Grey leg finish  
 Optional outdoor covers are available for Long Island. While not necessary for use outdoors, covers will provide added protection against dirt and the elements and reduce cleaning time  
 Care and consideration should be given to potential windy conditions when placing Long Island outdoor furniture on an upper floor balcony or terrace. Optional mounting brackets are available to secure the frames to the ground but cushions are not attached and should be removed during high wind events



		Seat										
		COM	Gr.1	Gr.2	Gr.3	Gr.4	Gr.5	Gr.6	Gr.7	Gr.8	Gr.9	Gr.10
1A	Chair with Two Arms	4400	4655	4769	4868	4981	5066	5137	5208	5293	5378	5463
		Gr.11	Gr.12	Gr.13	Gr.14	Gr.15	Gr.16	Gr.17	Gr.18	Gr.19	Gr.20	
1A	Chair with Two Arms	5563	5676	5818	5960	6101	6243	6385	6527	6668	6810	
		Frame										
		COM	Gr.1	Gr.2	Gr.3	Gr.4	Gr.5	Gr.6	Gr.7	Gr.8	Gr.9	Gr.10
1A	Chair with Two Arms	0	255	369	468	581	666	737	808	893	978	1063
		Gr.11	Gr.12	Gr.13	Gr.14	Gr.15	Gr.16	Gr.17	Gr.18	Gr.19	Gr.20	
1A	Chair with Two Arms	1163	1276	1418	1560	1701	1843	1985	2127	2268	4210	

## PNLSW point long island lounge sofa, outdoor environment

### Product Options

Configuration	Outdoor Seat Upholstery	Outdoor Frame Upholstery	Leg Finish
<b>2A</b> Two Seat Settee with Two Arms	Fabric	Fabric	<b>QG</b> Gunmetal Grey <b>QM</b> Mineral White
<b>3A</b> Three Seat Sofa with Two Arms			

**Note** Point Long Island is upholstered in a Railroad direction and consideration should be given when selecting textiles that feature patterns or texture  
 Point Long Island is only available in a Mineral White or Gunmetal Grey leg finish  
 Optional outdoor covers are available for Long Island. While not necessary for use outdoors, covers will provide added protection against dirt and the elements and reduce cleaning time  
 Care and consideration should be given to potential windy conditions when placing Long Island outdoor furniture on an upper floor balcony or terrace. Optional mounting brackets are available to secure the frames to the ground but cushions are not attached and should be removed during high wind events

#### Seat

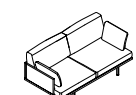

	COM	Gr.1	Gr.2	Gr.3	Gr.4	Gr.5	Gr.6	Gr.7	Gr.8	Gr.9	Gr.10
<b>2A</b> Two Seat Settee with Two Arms	8100	8564	8770	8951	9157	9312	9440	9569	9724	9879	10033
<b>3A</b> Three Seat Sofa with Two Arms	10500	11057	11304	11521	11768	11954	12109	12263	12449	12634	12820

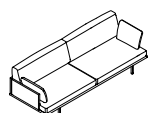

	Gr.11	Gr.12	Gr.13	Gr.14	Gr.15	Gr.16	Gr.17	Gr.18	Gr.19	Gr.20
<b>2A</b> Two Seat Settee with Two Arms	10214	10420	10678	10936	11193	11451	11709	11967	12224	12482
<b>3A</b> Three Seat Sofa with Two Arms	13037	13284	13593	13903	14212	14521	14831	15140	15449	15759

#### Frame

	COM	Gr.1	Gr.2	Gr.3	Gr.4	Gr.5	Gr.6	Gr.7	Gr.8	Gr.9	Gr.10
<b>2A</b> Two Seat Settee with Two Arms	0	464	670	851	1057	1212	1340	1469	1624	1779	1933
<b>3A</b> Three Seat Sofa with Two Arms	0	557	804	1021	1268	1454	1609	1763	1949	2134	2320

	Gr.11	Gr.12	Gr.13	Gr.14	Gr.15	Gr.16	Gr.17	Gr.18	Gr.19	Gr.20
<b>2A</b> Two Seat Settee with Two Arms	2114	2320	2578	2836	3093	3351	3609	3867	4124	4382
<b>3A</b> Three Seat Sofa with Two Arms	2537	2784	3093	3403	3712	4021	4331	4640	4949	5259







## PNLLW point long island lounge sectional, outdoor environment

### Product Options

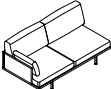
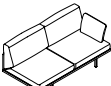
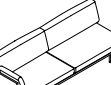
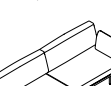
Configuration	Outdoor Seat Upholstery	Outdoor Frame Upholstery	Leg Finish
1C Corner Chair Sectional	Fabric	Fabric	<b>QG</b> Gunmetal Grey <b>QM</b> Mineral White
2L Two Seat Sectional with One Arm Left, Facing			
2R Two Seat Sectional with One Arm Right, Facing			
3L Three Seat Sectional with One Arm Left, Facing			
3R Three Seat Sectional with One Arm Right, Facing			

**Note** Point Long Island is upholstered in a Railroad direction and consideration should be given when selecting textiles that feature patterns or texture  
 Two seat Settee and three seat Sofa sectional components with one arm include a pair of ganging brackets to hold frames together when configured in an L shape or straight line  
 Point Long Island is only available in a Mineral White or Gunmetal Grey leg finish  
 Optional outdoor covers are available for Long Island. While not necessary for use outdoors, covers will provide added protection against dirt and the elements and reduce cleaning time  
 Care and consideration should be given to potential windy conditions when placing Long Island outdoor furniture on an upper floor balcony or terrace. Optional mounting brackets are available to secure the frames to the ground but cushions are not attached and should be removed during high wind events

### Seat

	COM	Gr.1	Gr.2	Gr.3	Gr.4	Gr.5	Gr.6	Gr.7	Gr.8	Gr.9	Gr.10
 1C Corner Chair Sectional	5000	5371	5536	5681	5846	5969	6072	6175	6299	6423	6547
 2L Two Seat Sectional with One Arm Left, Facing	7650	8068	8253	8416	8601	8740	8856	8972	9112	9251	9390
 2R Two Seat Sectional with One Arm Right, Facing	7650	8068	8253	8416	8601	8740	8856	8972	9112	9251	9390
 3L Three Seat Sectional with One Arm Left, Facing	10000	10510	10737	10936	11163	11333	11474	11616	11786	11957	12127
 3R Three Seat Sectional with One Arm Right, Facing	10000	10510	10737	10936	11163	11333	11474	11616	11786	11957	12127
	<b>Gr.11</b>	<b>Gr.12</b>	<b>Gr.13</b>	<b>Gr.14</b>	<b>Gr.15</b>	<b>Gr.16</b>	<b>Gr.17</b>	<b>Gr.18</b>	<b>Gr.19</b>	<b>Gr.20</b>	
 1C Corner Chair Sectional	6691	6856	7062	7268	7475	7681	7887	8093	8300	8506	
 2L Two Seat Sectional with One Arm Left, Facing	9552	9738	9970	10202	10434	10666	10898	11130	11362	11594	
 2R Two Seat Sectional with One Arm Right, Facing	9552	9738	9970	10202	10434	10666	10898	11130	11362	11594	
 3L Three Seat Sectional with One Arm Left, Facing	12325	12552	12836	13119	13403	13686	13970	14253	14537	14820	
 3R Three Seat Sectional with One Arm Right, Facing	12325	12552	12836	13119	13403	13686	13970	14253	14537	14820	

**PNLLW point long island lounge sectional, outdoor environment (continued)**

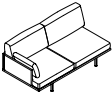
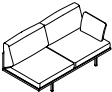
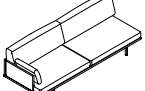
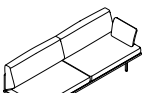
		<b>Frame</b>										
		<b>COM</b>	<b>Gr.1</b>	<b>Gr.2</b>	<b>Gr.3</b>	<b>Gr.4</b>	<b>Gr.5</b>	<b>Gr.6</b>	<b>Gr.7</b>	<b>Gr.8</b>	<b>Gr.9</b>	<b>Gr.10</b>
	<b>1C</b> Corner Chair Sectional	0	371	536	681	846	969	1072	1175	1299	1423	1547
	<b>2L</b> Two Seat Sectional with One Arm Left, Facing	0	418	603	766	951	1090	1206	1322	1462	1601	1740
	<b>2R</b> Two Seat Sectional with One Arm Right, Facing	0	418	603	766	951	1090	1206	1322	1462	1601	1740
	<b>3L</b> Three Seat Sectional with One Arm Left, Facing	0	510	737	936	1163	1333	1474	1616	1786	1957	2127
	<b>3R</b> Three Seat Sectional with One Arm Right, Facing	0	510	737	936	1163	1333	1474	1616	1786	1957	2127
		<b>Gr.11</b>	<b>Gr.12</b>	<b>Gr.13</b>	<b>Gr.14</b>	<b>Gr.15</b>	<b>Gr.16</b>	<b>Gr.17</b>	<b>Gr.18</b>	<b>Gr.19</b>	<b>Gr.20</b>	
	<b>1C</b> Corner Chair Sectional	1691	1856	2062	2268	2475	2681	2887	3093	3300	3506	
	<b>2L</b> Two Seat Sectional with One Arm Left, Facing	1902	2088	2320	2552	2784	3016	3248	3480	3712	3944	
	<b>2R</b> Two Seat Sectional with One Arm Right, Facing	1902	2088	2320	2552	2784	3016	3248	3480	3712	3944	
	<b>3L</b> Three Seat Sectional with One Arm Left, Facing	2325	2552	2836	3119	3403	3686	3970	4253	4537	4820	
	<b>3R</b> Three Seat Sectional with One Arm Right, Facing	2325	2552	2836	3119	3403	3686	3970	4253	4537	4820	

**PNLZW point long island outdoor seat cover**

**Product Options**

**Seat Configuration**

- 1 Cover for Long Island Lounge Chair
- 2 Cover for Long Island Two Seat Settee/Sectional
- 3 Cover for Long Island Three Seat Sofa/Sectional
- C Cover for Long Island Corner Sectional Chair

**Note** Cover size is determined by the number of seats, the lounge chair and corner sectional chair have unique covers  
 Ganging brackets must be removed from sectional components to use covers  
 Covers fit over the seat and may be secured using a strap under the frame  
 Covers are available in a Mineral White complement only

	Price
1 Cover for Long Island Lounge Chair	900
2 Cover for Long Island Two Seat Settee/Sectional	1150
3 Cover for Long Island Three Seat Sofa/Sectional	1250
C Cover for Long Island Corner Sectional Chair	900

**PNCBW point long island outdoor seating corner bracket pair**

**Product Options**

**Configuration**

- 2 Bracket Pair for Use on Two Legs

**Note** Corner Brackets are sold in pairs and secure two legs to the ground  
 Kit includes four L brackets (two per leg) and outdoor hardware to mount brackets to the furniture legs. Your installer will need to drill holes  
 L brackets are only available in a black finish  
 Outdoor ground mounting hardware IS NOT included and must be supplied by your installer for your specific installation requirements

	Price
2 Bracket Pair for Use on Two Legs	95