

modus art / abe / arne

features

Offered in partnership with Modus in South Somerset, UK, and designed by Michael Sodeau, the Modus Art; Modus Abe; and Modus Arne tables are a trio that share similarities while serving distinct purposes. Modus Art is the smallest of the three, featuring an angled cutout that is perfect for holding a book. The medium-sized Modus Abe has a lower shelf running around its entire perimeter. The largest table, Modus Arne, is designed to function best as a central coffee table, showcasing a concentric cutout on the top that is ideal for magazines.

sustainability

Modus Art; Modus Abe; and Modus Arne are made entirely from recycled waste materials generated during the production of wine bottle corks, using a solvent-free binder and are available with FSC certification upon request. Once they reach the end of their life cycle, the tables may be recycled into a finer grade cork composite ready for next life as a new product or biodegraded.

Cork is a renewable material harvested from the outer bark of the Mediterranean cork oak tree without harm to the tree. The bark will regenerate and is typically harvested once a decade. As it regenerates, it can absorb up to five times more CO₂ than a cork tree left undisturbed. Mediterranean cork forests help sequester an estimated 14 million tons of carbon annually.

Cork oak forests are rich in biodiversity, and these trees can live up to 250 years. The cork harvesting process supports communities in southern Europe and northern Africa and is highly sustainable, positively impacting the natural environment.

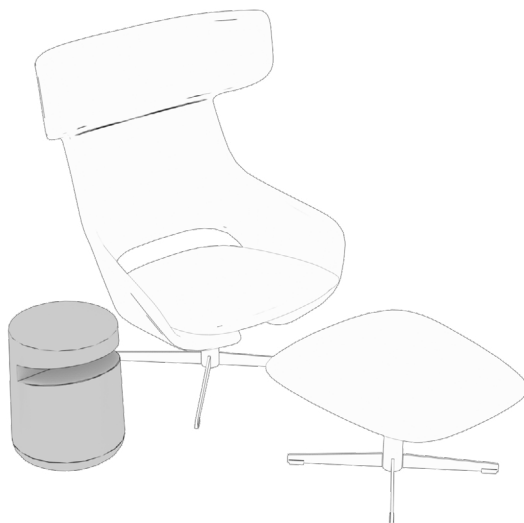

dimensions

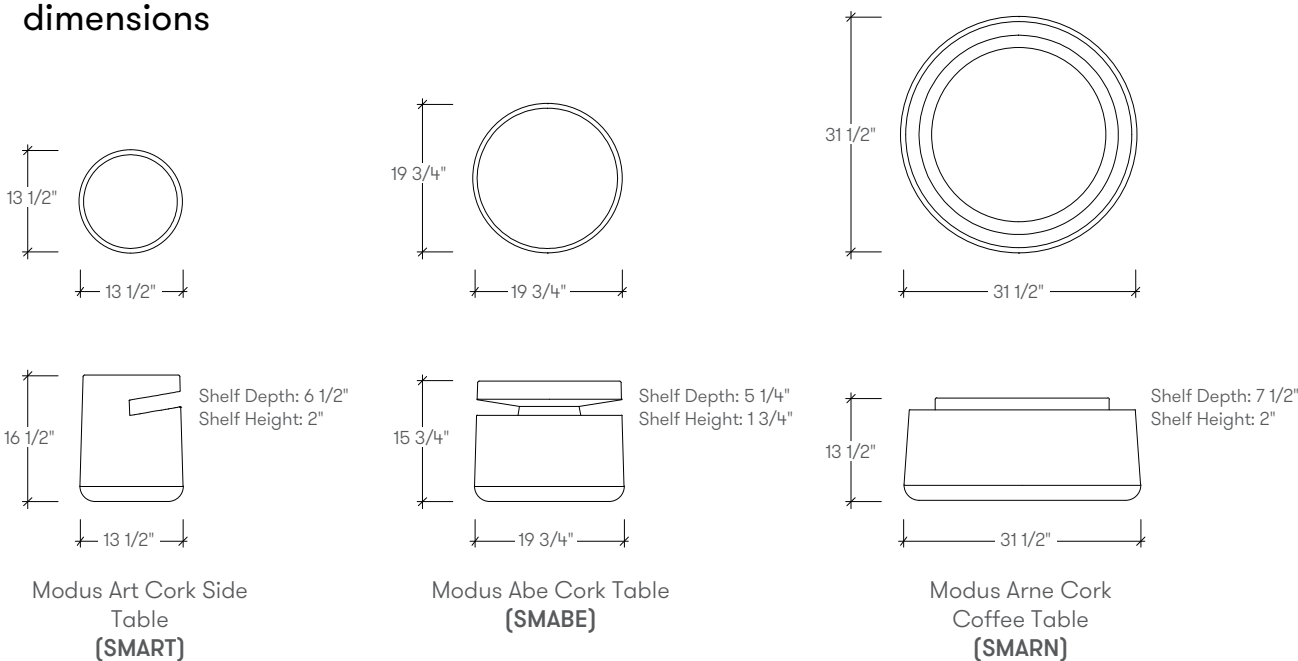

modus art / abe / arne

planning

Modus Art, the smallest of the three, features an angled cutout that is perfect for holding a book. The medium-sized Modus Abe has a lower shelf running around its entire perimeter. The largest table, Modus Arne, is designed to function best as a central coffee table, showcasing a concentric cutout on the top that is ideal for magazines. Constructed entirely of cork, these sturdy tables feature a natural cork finish.

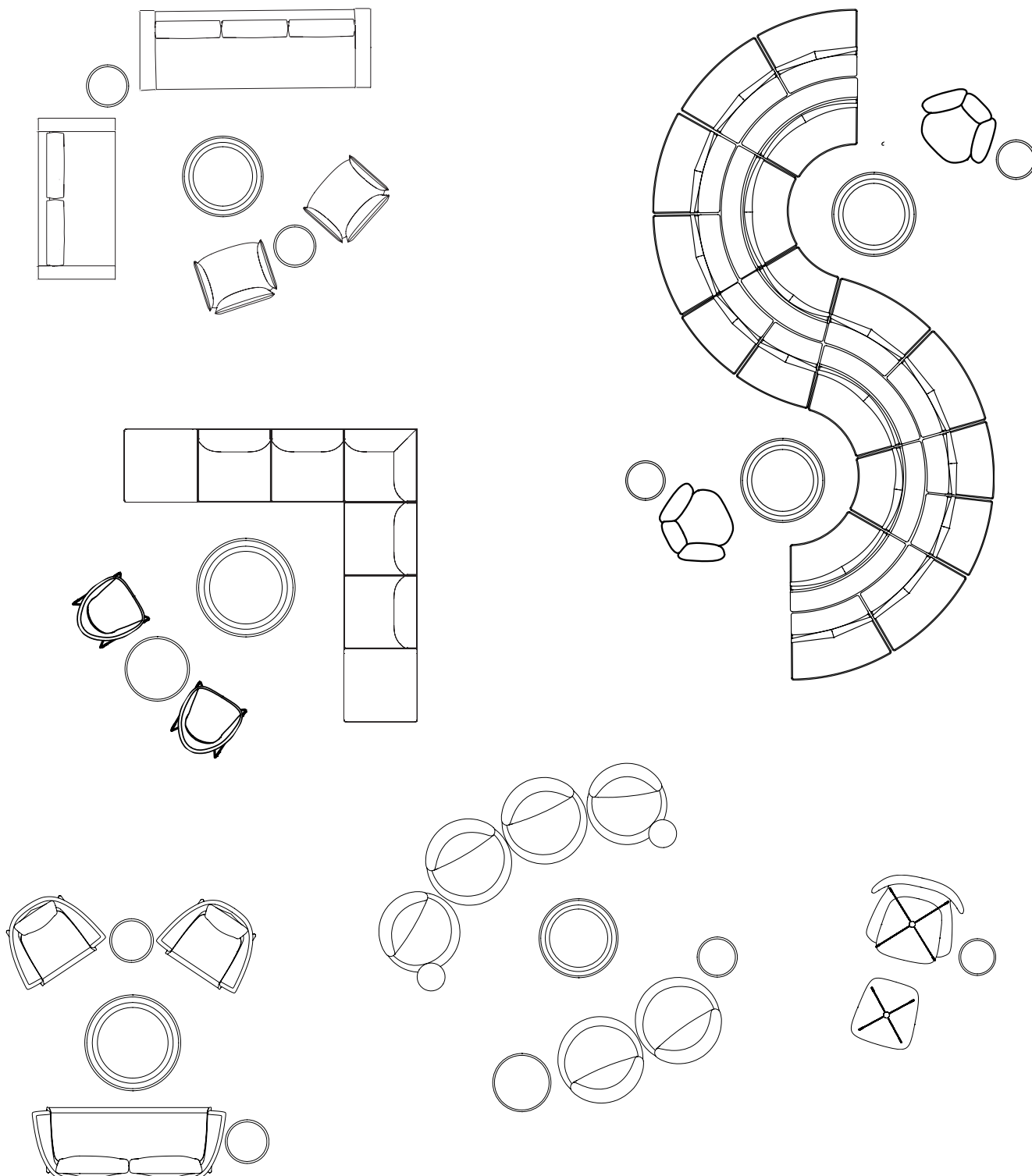

specifying art, abe and arne finishes

Art, Abe and Arne occasional tables feature a natural cork finish.

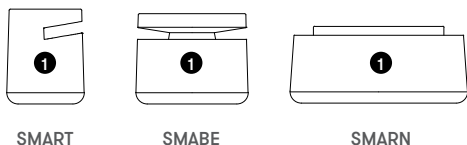

1 Cork Finish
Select cork finish

specification example

Cork tables are available in three sizes.

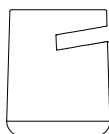

Steps involved in specifying cork tables

- Select the Art, Abe or Arne cork table
- Select the configuration
- Select the cork finish

Example:

SMART
SMART001
SMART001MNC

care instructions

Cork should be regularly cleaned with a soft cloth or duster. Stains should be tackled immediately with warm, soapy water, working from circumference to center and rubbing gently. Repeat as necessary.

All cork items are sensitive to UV and will fade if left exposed to sunlight. Turn regularly to avoid bleach lines.

SMART modus art cork side table**Product Options****Configuration**

001 Small 13.5" Dia x 15.5"H / 34.5 cm Dia x 42 cm H

Modus Cork Finish

MNC Natural Cork

**Price**

975

SMABE modus abe cork side table**Product Options****Configuration**

001 Medium 19.5" Dia x 15.75"H / 50 cm Dia x 40 cm H

Modus Cork Finish

MNC Natural Cork

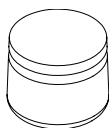
**Price**

1775

SMARN modus arne cork coffee table**Product Options****Configuration**

001 Large 31.25" Dia x 13.5"H / 79.5 cm Dia x 34 cm H

Modus Cork Finish

MNC Natural Cork

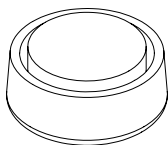
**Price**

2750