

# fractals nook

## features

Fractals Nook, an extension of the Fractals Seating product, uses an organic high shell with an added worksurface to create an intimate desk carrel for heads down work. Fractals Nook allows for users to create a distraction free zone for work. The natural curves of Fractals create unique space planning capabilities for social spaces that require the need for privacy. The addition of the Fractals Nook now allows for new planning scenarios for the complete Fractals line. It offers the ability to intertwine high back lounge pieces with high desk nooks.

Fractals Nook allows the same broad canvas of the lounge series for the selection of multiple fabrics and finishes to create your own distinctive look. Powder coat finishes on both the legs and the inner frame are chosen individually as well as inner and outer fabric selection for those environments that encourage space division emphasized by finish.

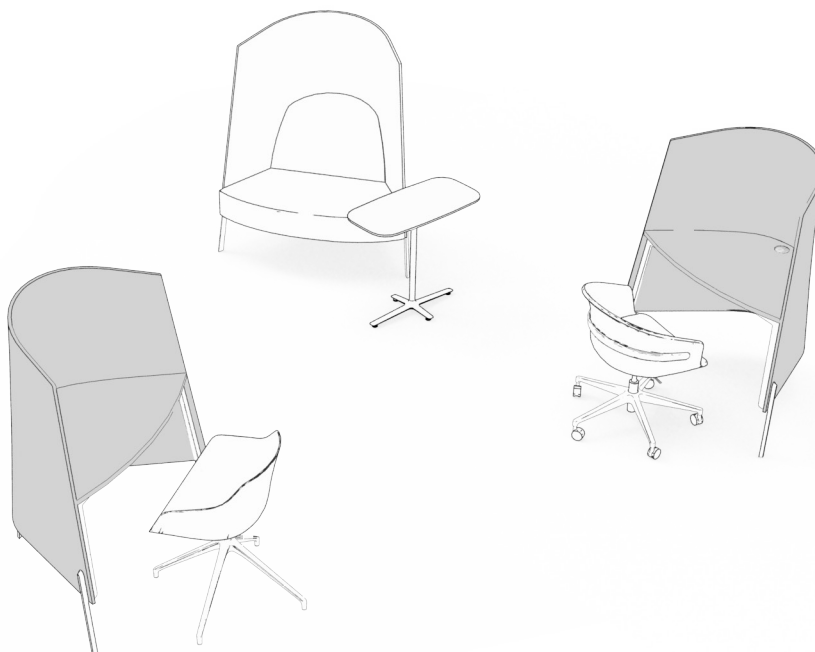

## dimensions

- Meets ANSI/BIFMA X5.5

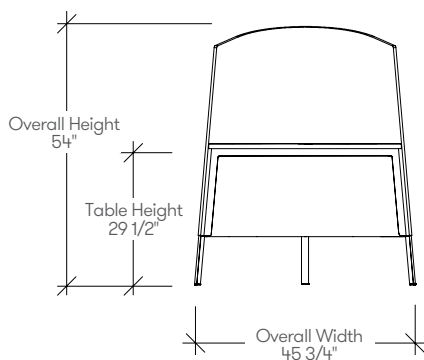

Fractals Nook  
(STFNN)  
side view

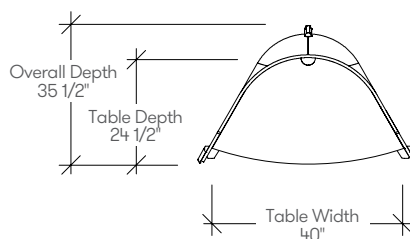

Fractals Nook  
(STFNN)  
front view

# fractals nook

## planning

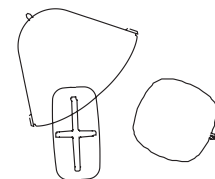
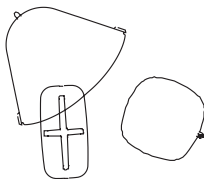
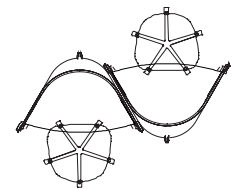
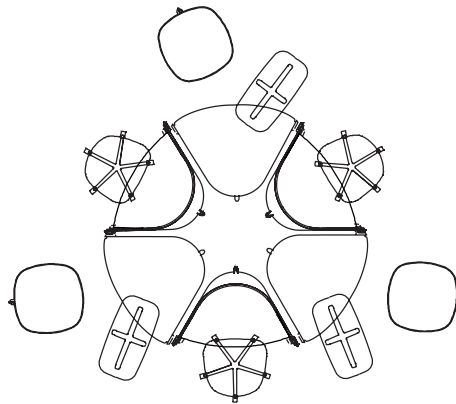
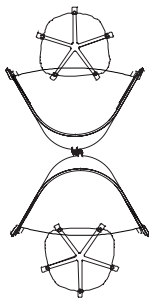
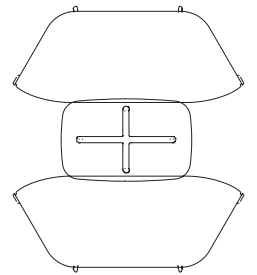
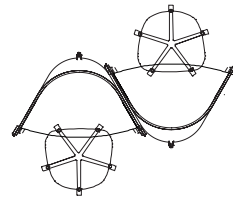
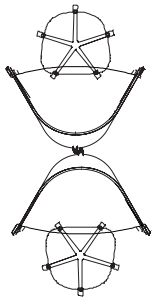
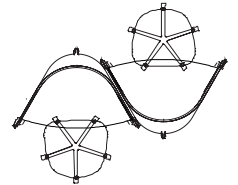
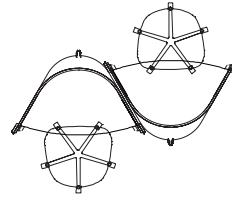
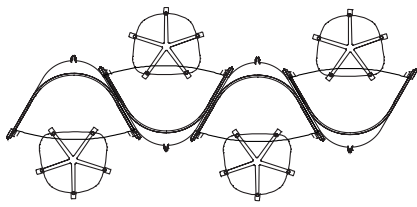

## specifying fractals nook finishes

Fractals Nook permits a wide range of combinations that vary dependent of the configuration specified. The following demonstrates the order that must be selected.

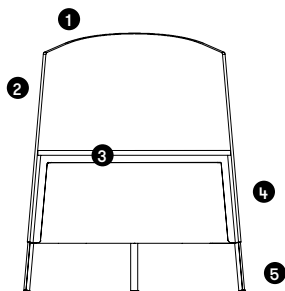

**1 Inner Back Upholstery**  
Select inner back upholstery

**2 Outer Back Upholstery**  
Select outer back upholstery

**3 Surface Finish**  
Select surface finish

**4 Inner Frame Finish**  
Select inner frame finish

**5 Leg Finish**  
Select leg finish

## specification example

STFND Fractals Nook, Power Cut Out for Single Round Bump	
<b>1</b> Inner Back Gr. 5	3177
<b>2</b> Outer Back Gr. 3	125
<b>3</b> Surface Finish Foundation Laminate	0
<b>Total:</b>	<b>\$3303</b>

STFND Fractals Nook, Power Cut Out for Single Round Bump	
<b>1</b> Inner Back Gr. 9	3364
<b>2</b> Outer Back Gr. 3	125
<b>3</b> Surface Finish Veneer	253
<b>Total:</b>	<b>\$3741</b>

STFNN Fractals Nook, No Cut Out	
<b>1</b> Inner Back Gr. 5	3202
<b>2</b> Outer Back Gr. 3	125
<b>3</b> Surface Finish Foundation Laminate	0
<b>Total:</b>	<b>\$3328</b>

STFNN Fractals Nook, No Cut Out	
<b>1</b> Inner Back Gr. 9	3389
<b>2</b> Outer Back Gr. 3	125
<b>3</b> Surface Finish Veneer	253
<b>Total:</b>	<b>\$3767</b>

## COM/COL material requirement

Yardage is based on a non-patterned fabric. Additional yardage may be required for pattern repeats and the matching required. Leather yield may be affected by the quality of the COL. However, variance in the size of the hides will not affect the yield.

### SINGLE UPHOLSTERY

	COM [yards]	COL [sq. ft.]
Inner Back	3	54
Outer Back	3	54

**STFN fractals nook**

**Product Options**

Power Cut Out	Inner Back Upholstery	Outer Back Upholstery	Surface Finish	Inner Frame Finish	Leg Finish
<b>N</b> No Cut Out	Fabric	Fabric	Studio Foundation Laminate	Fundamental Paint	C6 Chrome
<b>D</b> Power Cut Out for Single Round Power Bump			Leather	Leather	Fashion Paint
			Grade 2 Laminate		Fashion Paint
			Studio Veneer		

**Note** For Foundation Laminate Surface, add \$0  
 For Grade 2 Laminate Surface, add \$109  
 For Studio Veneer Surface, add \$253  
 For Inner Frame Fundamental and Fashion Paint, add \$0  
 For Chrome Leg, add \$0  
 For Fundamental Leg Finish, add \$70  
 For Fashion Leg Finish, add \$95  
 POWER UNIT SOLD SEPARATELY



**Inner Back**

	COM	COL	Gr.1	Gr.2	Gr.3	Gr.4	Gr.5	Gr.6	Gr.7	Gr.8	Gr.9	Gr.10	Gr. 11
<b>N</b> No Cut Out	2893	3067	3024	3081	3133	3190	3234	3271	3307	3351	3394	3438	3489
<b>D</b> Power Cut Out	2919	3095	3050	3108	3159	3217	3260	3297	3333	3377	3420	3464	3515

	Gr.12	Gr.13	Gr.14	Gr.15	Gr.16	Gr.17	Gr.18	Gr.19	Gr.20	Leather		
										LB	LC	LD
<b>N</b> No Cut Out	3547	3620	3692	3765	3838	3910	3983	4056	4128	3852	4244	4375
<b>D</b> Power Cut Out	3573	3646	3718	3791	3864	3936	4009	4082	4154	3879	4272	4403

**Outer Back**

	COM	COL	Gr.1	Gr.2	Gr.3	Gr.4	Gr.5	Gr.6	Gr.7	Gr.8	Gr.9	Gr.10	Gr. 11
<b>N</b> No Cut Out	0	126	69	98	125	156	179	197	216	239	262	284	311
<b>D</b> Power Cut Out	0	126	69	98	125	156	179	197	216	239	262	284	311

	Gr.12	Gr.13	Gr.14	Gr.15	Gr.16	Gr.17	Gr.18	Gr.19	Gr.20	Leather		
										LB	LC	LD
<b>N</b> No Cut Out	341	379	417	456	493	531	569	607	645	410	615	682
<b>D</b> Power Cut Out	341	379	417	456	493	531	569	607	645	410	615	682