

borough

features

Hospitable by nature, elegant by design, the modular lounge collection introduces a casual sophistication to any social setting. Borough lounge raises the bar of modular seating by combining home seating elements with the modular flexibility necessary for today's workplace. The application options of Borough are endless. The broad array of individual modular pieces expands the possibility of adaptation when planning spaces not only today but well into the future. As the needs of a workplace change, the Borough Lounge can adapt to fill those needs because of its compatible sectional geometry. The uses can be as simple as a single seat banquette to a room-filling back-to-back serpentine. Borough's modular system brings elegance, comfort, versatility, and functionality to any office environment.

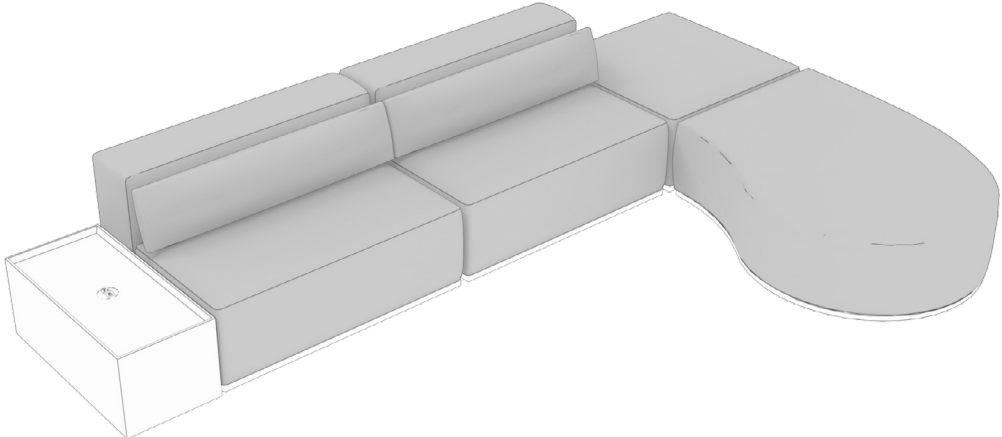

dimensions

- Designed and tested for users up to 300 lbs
- Meets ANSI/BIFMA requirements

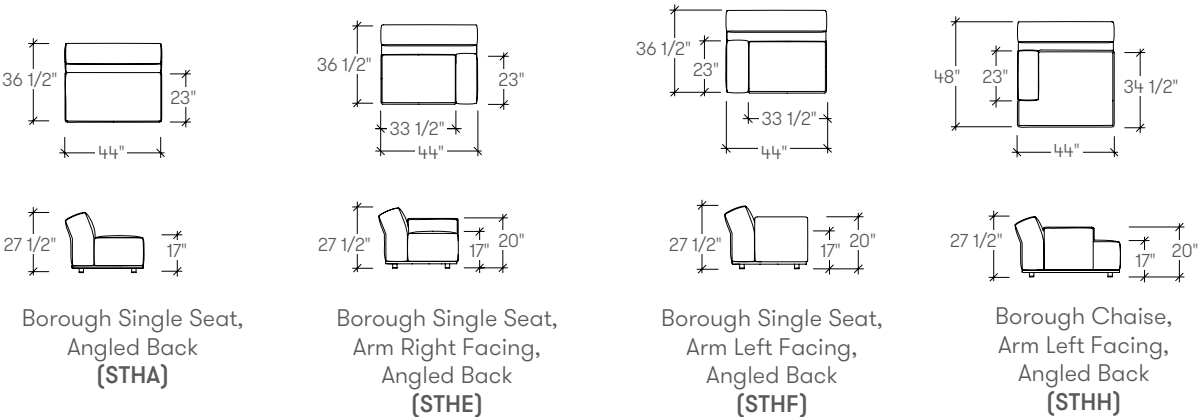

borough

dimensions (continued)

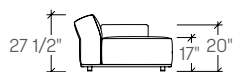
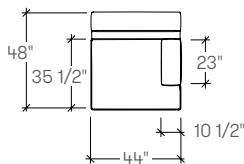

Borough Chaise,
Arm Right Facing,
Angled Back
(STHG)

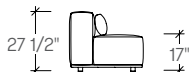
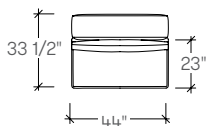

Borough Single Seat,
Straight Back
(STHB)

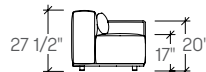
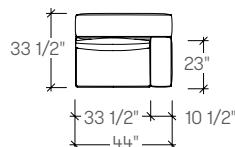

Borough Single Seat,
Arm Right Facing,
Straight Back
(STHC)

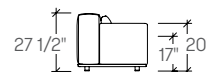
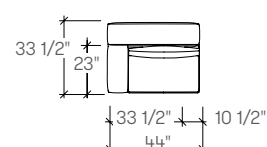

Borough Single Seat,
Arm Left Facing,
Straight Back
(STHD)

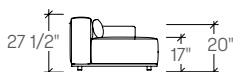
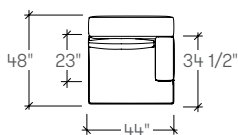

Borough Chaise,
Arm Right Facing,
Straight Back
(STHJ)

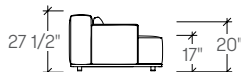
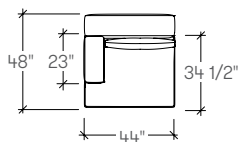

Borough Chaise,
Arm Left Facing,
Straight Back
(STHK)

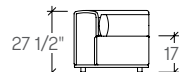
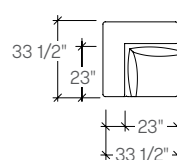

Borough Single Seat,
90 Corner,
Straight Back
(STHL)

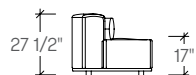
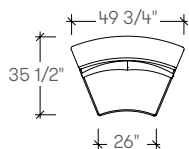

Borough Single Seat,
45 Inside Curve,
Straight Back
(STHW)

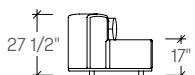
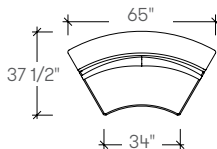

Borough Single Seat,
60 Inside Curve,
Straight Back
(STHX)

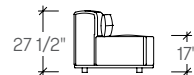
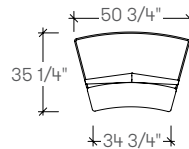

Borough Single Seat,
30 Outside Curve,
Straight Back
(STHY)

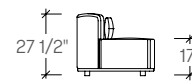
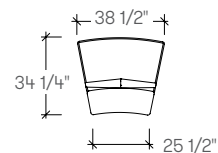

Borough Single Seat,
22.5 Outside Curve,
Straight Back
(STHZ)

borough

dimensions (continued)

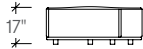
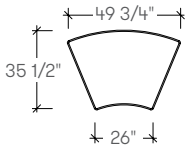

Borough Bench,
45 Inside Curve
(STHS)

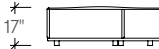
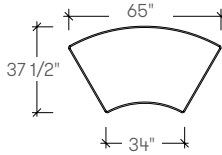

Borough Bench,
60 Inside Curve,
(STHT)

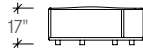
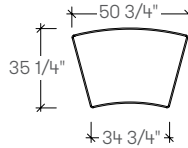

Borough Bench,
30 Outside Curve
(STHU)

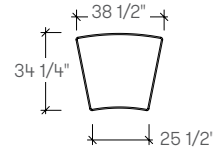

Borough Bench,
22.5 Outside Curve
(STHV)

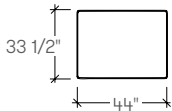

Borough Bench,
Rectangle
(STHM)

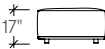
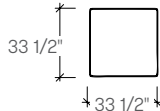

Borough Bench,
Square
(STHN)

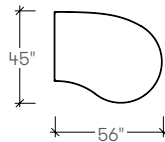

Borough Rounded
Bench,
Right Facing
(STHR)

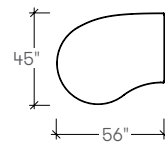

Borough Rounded
Bench,
Left Facing
(STHQ)

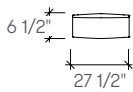

Borough Pillow,
Large Rectangular
(STHPA)

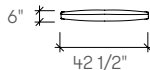

Borough Pillow,
Lumbar Long
(STHPB)

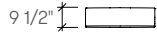
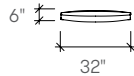

Borough Pillow,
Lumbar Short
(STHPC)

borough

planning

A variety of configurations can be achieved with Borough, allowing for various configurations. The following typical demonstrate the versatility that can be achieved.

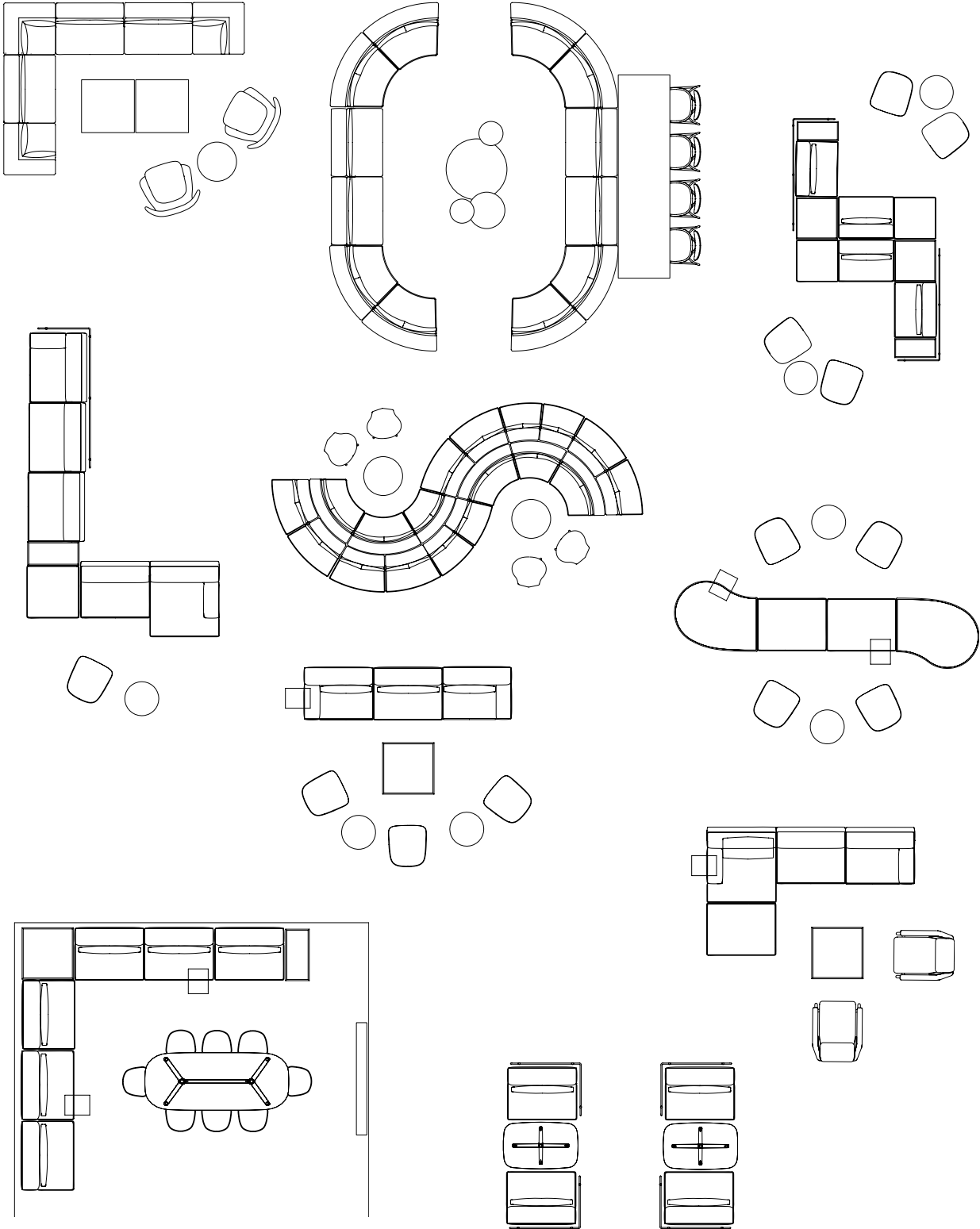

borough

details

The curved modular pieces are designed to form a double serpentine or be placed back to back.

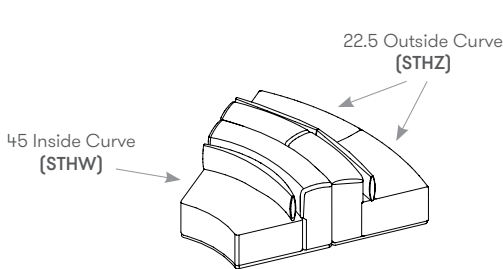
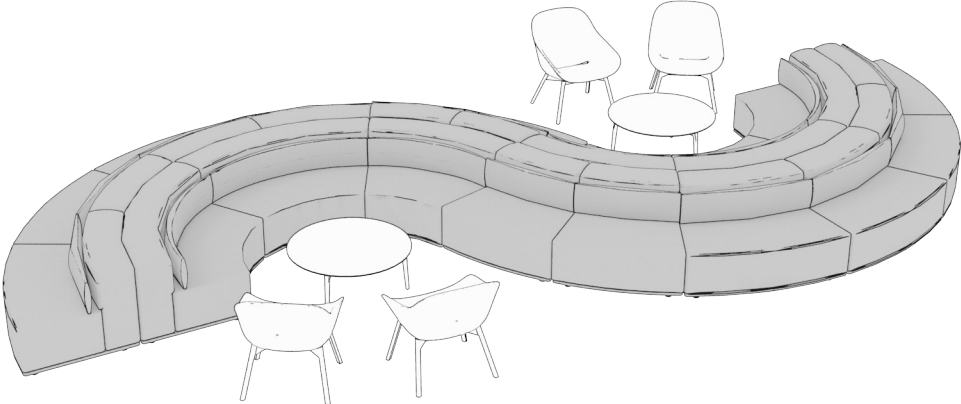

Two 22.5 Outside Curve units pair with one 45 Inside Curve Unit

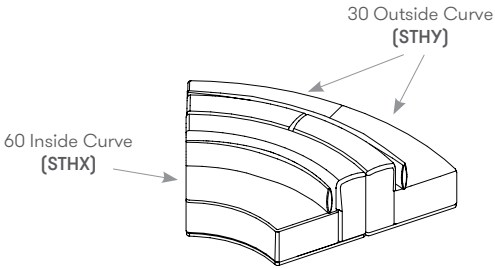

Two 30 Outside Curve units pair with one 60 Inside Curve Unit

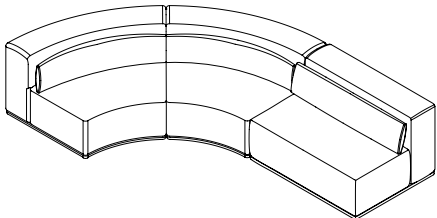

Two 45 units can be ganged to create a curved 90

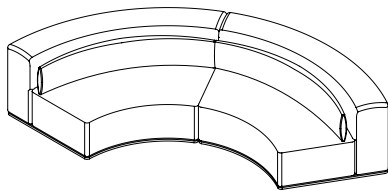

Two 60 Units can be ganged to create a curved 120

note on finishes

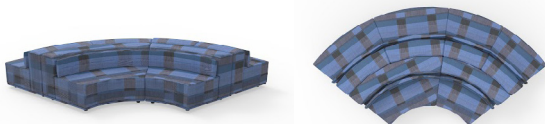

Studio TK does not recommend using patterned or striped textiles on the Borough Lounge. These textiles will become askew during the fabrication process, which causes distortions to the pattern or stripes, deviations to the pattern or stripe across the entire piece of furniture, and pattern or stripe misalignments from sectional to sectional. For these reasons, Studio TK will not accept warranty claims for pattern matching distortions, deviations or misalignments when patterned or striped textiles are applied to the Borough Lounge.

specifying borough finishes

The modularity of Borough permits a wide range of fabric combinations that allows for an expressive use of color, texture and material.

Note:

Studio TK does not recommend using patterned or striped textiles on the Borough Lounge. These textiles will become askew during the fabrication process, which causes distortions to the pattern or stripes, deviations to the pattern or stripe across the entire piece of furniture, and pattern or stripe misalignments from sectional to sectional. For these reasons, Studio TK will not accept warranty claims for pattern matching distortions, deviations or misalignments when patterned or striped textiles are applied to the Borough Lounge.

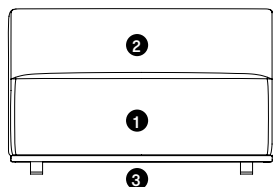

- 1 Seat Upholstery**
Select the seat upholstery
- 2 Back Upholstery**
Select the back upholstery
- 3 Base Finish**
Select fabric

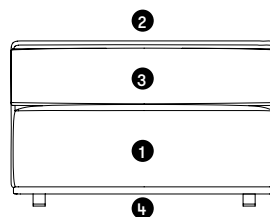

- 1 Seat Upholstery**
Select the seat upholstery
- 2 Back Upholstery**
Select the back upholstery
- 3 Lumbar Pillow Upholstery**
Select the lumbar pillow upholstery
- 4 Base Finish**
Select fabric

arm placement

Arm placement is determined by standing in front of a seat. A “Left Facing” arm is to your left when looking at the seat and to your right when sitting in the seat.

specification example

STHAU Borough Single Seat, Angled Back, Upholstered Base		
1	Seat fabric Gr.5	2652
2	Back fabric Gr.5	529
3	Base fabric Gr.5	264
Total:		\$3444

STHAU Borough Single Seat, Angled Back, Upholstered Base		
1	Seat fabric Gr.5	2652
2	Back fabric Gr.3	371
3	Base fabric Gr.5	264
Total:		\$3286

STHAU Borough Single Seat, Angled Back, Upholstered Base		
1	Seat fabric Gr.5	2652
2	Back fabric Gr.9	775
3	Base fabric Gr.5	264
Total:		\$3691

STHBU Borough Single Seat, Straight Back, Upholstered Back		
1	Seat fabric Gr.5	2652
2	Back fabric Gr.5	529
3	Lumbar fabric Gr.5	264
4	Base fabric Gr.5	264
Total:		\$3708

STHBU Borough Single Seat, Straight Back, Upholstered Back		
1	Seat fabric Gr.5	2652
2	Back fabric Gr.3	371
3	Lumbar fabric Gr.3	186
4	Base fabric Gr.5	264
Total:		\$3472

STHBU Borough Single Seat, Straight Back, Upholstered Back		
1	Seat fabric Gr.5	2652
2	Back fabric Gr.9	775
3	Lumbar fabric Gr.9	388
4	Base fabric Gr.5	264
Total:		\$4079

weights

Borough Single Seat, Angled Back	101 - 107 lbs
Borough Single Seat, Arm Right Facing, Angled Back	101 - 107 lbs
Borough Single Seat, Arm Left Facing, Angled Back	101 - 107 lbs
Borough Chaise, Arm Right Facing, Angled Back	101 - 107 lbs
Borough Chaise, Arm Left Facing, Angled Back	101 - 107 lbs
Borough Single Seat, Straight Back	101 - 107 lbs
Borough Single Seat, Arm Right Facing, Straight Back	101 - 107 lbs
Borough Single Seat, Arm Left Facing, Straight Back	101 - 107 lbs
Borough Single Seat, 90 Corner, Straight Back	111 - 117 lbs
Borough Single Seat, 45 Inside, Straight Back	106 - 112 lbs
Borough Single Seat, 60 Inside, Straight Back	111 - 117 lbs
Borough Single Seat, 30 Outside, Straight Back	106 - 112 lbs
Borough Single Seat, 22.5 Outside, Straight Back	101 - 106 lbs
Borough Chaise, Arm Right Facing, Straight Back	101 - 107 lbs
Borough Chaise, Arm Left Facing, Straight Back	101 - 107 lbs
Borough Bench, Rectangle	86 - 91 lbs
Borough Bench, Square	80 - 85 lbs
Borough Rounded Bench, Right Facing	110 - 117 lbs
Borough Rounded Bench, Left Facing	110 - 117 lbs
Borough Bench, 45 Inside, Straight Back	91 - 96 lbs
Borough Bench, 60 Inside, Straight Back	96 - 101 lbs
Borough Bench, 30 Outside, Straight Back	87 - 92 lbs
Borough Bench, 22.5 Outside, Straight Back	86 - 91 lbs

COM/COL material
requirement

Yardage is based on a non-patterned fabric. Additional yardage may be required for pattern repeats and the matching required. Leather yield may be affected by the quality of the COL. However, variance in the size of the hides will not affect the yield.

SINGLE UPHOLSTERY		COM [yards]	COL [sq. ft.]
Single Seat, Angled Back, No Arm	Seat	3 1/4	58 1/2
	Back	4	72
	Base	2	36
Single Seat, Angled Back One Arm	Seat & Arm	5	90
	Back	4	72
	Base	2	36
Chaise, Angled Back One Arm	Seat & Arm	5	90
	Back	4	72
	Base	2	36
Single Seat, Straight Back, No Arm	Seat	3 1/4	58 1/2
	Back	4	72
	Base	2	36
	Pillow	2	36
Single Seat, Straight Back One Arm	Seat & Arm	5	90
	Back	4	72
	Base	2	36
	Pillow	2	36
Chaise, Straight Back One Arm	Seat & Arm	5	90
	Back	4	72
	Base	2	36
	Pillow	2	36
Single Seat, 45 Inside, Straight Back	Seat	3	54
	Back	3 3/4	67 1/2
	Base	2	36
	Pillow	2	36
Single Seat, 60 Inside, Straight Back	Seat	3 3/4	67 1/2
	Back	5 1/2	99
	Base	2	36
	Pillow	2 1/2	45
Single Seat, 30 Outside, Straight Back	Seat	3 3/4	67 1/2
	Back	4 1/4	76 1/2
	Base	2	36
	Pillow	2	36
Single Seat, 22.5 Outside, Straight Back	Seat	3 3/4	67 1/2
	Back	4 1/4	76 1/2
	Base	2	36
	Pillow	2	36
Single Seat, 90 Corner, Straight Back	Seat	2 1/2	45
	Back	4 1/4	76 1/2
	Base	2	36
	Pillow	2	36
Bench, Rectangle	Seat	4	72
	Base	2	36
Bench, Square	Seat	3 1/2	63
	Base	2	36
Rounded Bench	Seat	6	108
	Base	2	36
Bench, 45 Inside	Seat	3 3/4	67 1/2
	Base	2	36
Bench, 60 Inside	Seat	5	90
	Base	2	36
Bench, 30 Outside	Seat	5	90
	Base	2	36
Bench, 22.5 Outside	Seat	4 1/4	76 1/2
	Base	2	36
Pillows	Short, Lumbar	2	36
	Long, Lumbar	2	36
	Rectangle	2	36

STHA **borough single seat, angled back**

Product Options

Base Style	Seat Upholstery Finish	Back Upholstery Finish	Base Finish
U Upholstered	Fabric Leather	Fabric Leather	Fabric Leather

Note All pillows are sold separately for Angled Back version

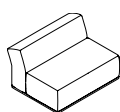

		Seat												
		COM	COL	Gr.1	Gr.2	Gr.3	Gr.4	Gr.5	Gr.6	Gr.7	Gr.8	Gr.9	Gr.10	Gr.11
U Upholstered		2334	2474	2498	2571	2635	2708	2763	2809	2855	2909	2964	3018	3083
												Leather LB	LC	LD
U Upholstered		3156	3247	3339	3429	3521	3612	3704	3794	3886		3461	3953	4118
		Back												
		COM	COL	Gr.1	Gr.2	Gr.3	Gr.4	Gr.5	Gr.6	Gr.7	Gr.8	Gr.9	Gr.10	Gr.11
U Upholstered		0	126	203	292	371	460	529	584	641	709	775	844	922
												Leather LB	LC	LD
U Upholstered		1012	1124	1236	1349	1462	1573	1685	1799	1911		1323	1947	2149
		Base												
		COM	COL	Gr.1	Gr.2	Gr.3	Gr.4	Gr.5	Gr.6	Gr.7	Gr.8	Gr.9	Gr.10	Gr.11
U Upholstered		0	126	101	147	186	230	264	292	319	354	388	421	460
												Leather LB	LC	LD
U Upholstered		506	561	618	674	730	787	844	899	956		716	1037	1138

STHE **borough single seat, arm right facing, angled back**

Product Options

Base Style	Seat and Arm Upholstery Finish	Back Upholstery Finish	Base Finish
U Upholstered	Fabric Leather	Fabric Leather	Fabric Leather

Note All pillows are sold separately for Angled Back version

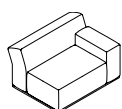

Seat

	COM	COL	Gr.1	Gr.2	Gr.3	Gr.4	Gr.5	Gr.6	Gr.7	Gr.8	Gr.9	Gr.10	Gr.11
U Upholstered	2694	2857	2947	3060	3158	3270	3355	3425	3496	3580	3663	3749	3847
											Leather LB	LC	LD
U Upholstered	3959	4099	4240	4381	4521	4661	4801	4942	5083		4374	5133	5386

Back

	COM	COL	Gr.1	Gr.2	Gr.3	Gr.4	Gr.5	Gr.6	Gr.7	Gr.8	Gr.9	Gr.10	Gr.11
U Upholstered	0	126	203	292	371	460	529	584	641	709	775	844	922
											Leather LB	LC	LD
U Upholstered	1012	1124	1236	1349	1462	1573	1685	1799	1911		1323	1947	2149

Base

	COM	COL	Gr.1	Gr.2	Gr.3	Gr.4	Gr.5	Gr.6	Gr.7	Gr.8	Gr.9	Gr.10	Gr.11
U Upholstered	0	126	101	147	186	230	264	292	319	354	388	421	460
											Leather LB	LC	LD
U Upholstered	506	561	618	674	730	787	844	899	956		716	1037	1138

STHF **borough single seat, arm left facing, angled back**

Product Options

Base Style	Seat and Arm Upholstery Finish	Back Upholstery Finish	Base Finish
U Upholstered	Fabric Leather	Fabric Leather	Fabric Leather

Note All pillows are sold separately for Angled Back version

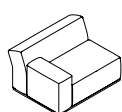

Seat

	COM	COL	Gr.1	Gr.2	Gr.3	Gr.4	Gr.5	Gr.6	Gr.7	Gr.8	Gr.9	Gr.10	Gr.11
U Upholstered	2694	2857	2947	3060	3158	3270	3355	3425	3496	3580	3663	3749	3847
											Leather LB	LC	LD
U Upholstered	3959	4099	4240	4381	4521	4661	4801	4942	5083		4374	5133	5386

Back

	COM	COL	Gr.1	Gr.2	Gr.3	Gr.4	Gr.5	Gr.6	Gr.7	Gr.8	Gr.9	Gr.10	Gr.11
U Upholstered	0	126	203	292	371	460	529	584	641	709	775	844	922
											Leather LB	LC	LD
U Upholstered	1012	1124	1236	1349	1462	1573	1685	1799	1911		1323	1947	2149

Base

	COM	COL	Gr.1	Gr.2	Gr.3	Gr.4	Gr.5	Gr.6	Gr.7	Gr.8	Gr.9	Gr.10	Gr.11
U Upholstered	0	126	101	147	186	230	264	292	319	354	388	421	460
											Leather LB	LC	LD
U Upholstered	506	561	618	674	730	787	844	899	956		716	1037	1138

STHG **borough chaise, arm right facing, angled back**

Product Options

Base Style	Seat and Arm Upholstery Finish	Back Upholstery Finish	Base Finish
U Upholstered	Fabric Leather	Fabric Leather	Fabric Leather

Note All pillows are sold separately for Angled Back version

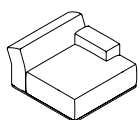

Seat

	COM	COL	Gr.1	Gr.2	Gr.3	Gr.4	Gr.5	Gr.6	Gr.7	Gr.8	Gr.9	Gr.10	Gr.11
U Upholstered	3053	3236	3306	3418	3516	3629	3714	3783	3854	3938	4022	4107	4205
											Leather LB	LC	LD
U Upholstered	4317	4458	4599	4739	4880	5019	5160	5301	5441		4753	5512	5765

Back

	COM	COL	Gr.1	Gr.2	Gr.3	Gr.4	Gr.5	Gr.6	Gr.7	Gr.8	Gr.9	Gr.10	Gr.11
U Upholstered	0	126	203	292	371	460	529	584	641	709	775	844	922
											Leather LB	LC	LD
U Upholstered	1012	1124	1236	1349	1462	1573	1685	1799	1911		1323	1947	2149

Base

	COM	COL	Gr.1	Gr.2	Gr.3	Gr.4	Gr.5	Gr.6	Gr.7	Gr.8	Gr.9	Gr.10	Gr.11
U Upholstered	0	126	101	147	186	230	264	292	319	354	388	421	460
											Leather LB	LC	LD
U Upholstered	506	561	618	674	730	787	844	899	956		716	1037	1138

STHH **borough** chaise, arm left facing, angled back

Product Options

Base Style	Seat and Arm Upholstery Finish	Back Upholstery Finish	Base Finish
U Upholstered	Fabric Leather	Fabric Leather	Fabric Leather

Note All pillows are sold separately for Angled Back version

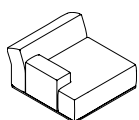

Seat

	COM	COL	Gr.1	Gr.2	Gr.3	Gr.4	Gr.5	Gr.6	Gr.7	Gr.8	Gr.9	Gr.10	Gr.11
U Upholstered	3053	3236	3306	3418	3516	3629	3714	3783	3854	3938	4022	4107	4205
											Leather LB	LC	LD
U Upholstered	4317	4458	4599	4739	4880	5019	5160	5301	5441		4753	5512	5765

Back

	COM	COL	Gr.1	Gr.2	Gr.3	Gr.4	Gr.5	Gr.6	Gr.7	Gr.8	Gr.9	Gr.10	Gr.11
U Upholstered	0	126	203	292	371	460	529	584	641	709	775	844	922
											Leather LB	LC	LD
U Upholstered	1012	1124	1236	1349	1462	1573	1685	1799	1911		1323	1947	2149

Base

	COM	COL	Gr.1	Gr.2	Gr.3	Gr.4	Gr.5	Gr.6	Gr.7	Gr.8	Gr.9	Gr.10	Gr.11
U Upholstered	0	126	101	147	186	230	264	292	319	354	388	421	460
											Leather LB	LC	LD
U Upholstered	506	561	618	674	730	787	844	899	956		716	1037	1138

STHB **borough single seat, straight back**

Product Options

Base Style	Seat Upholstery Finish	Back Upholstery Finish	Lumbar Pillow Upholstery Finish	Base Finish
U Upholstered	Fabric Leather	Fabric Leather	Fabric Leather	Fabric Leather

Note Lumbar pillow always included on the Straight Back version
 Lumbar pillows rest loose on the seat

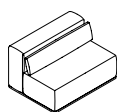

Seat

	COM	COL	Gr.1	Gr.2	Gr.3	Gr.4	Gr.5	Gr.6	Gr.7	Gr.8	Gr.9	Gr.10	Gr.11
U Upholstered	2334	2474	2498	2571	2635	2708	2763	2809	2855	2909	2964	3018	3083
											Leather LB	LC	LD
U Upholstered	3156	3247	3339	3429	3521	3612	3704	3794	3886		3461	3953	4118

Back

	COM	COL	Gr.1	Gr.2	Gr.3	Gr.4	Gr.5	Gr.6	Gr.7	Gr.8	Gr.9	Gr.10	Gr.11
U Upholstered	0	126	203	292	371	460	529	584	641	709	775	844	922
											Leather LB	LC	LD
U Upholstered	1012	1124	1236	1349	1462	1573	1685	1799	1911		1323	1947	2149

Lumbar Pillow

	COM	COL	Gr.1	Gr.2	Gr.3	Gr.4	Gr.5	Gr.6	Gr.7	Gr.8	Gr.9	Gr.10	Gr.11
U Upholstered	0	126	101	147	186	230	264	292	319	354	388	421	460
											Leather LB	LC	LD
U Upholstered	506	561	618	674	730	787	844	899	956		716	1037	1138

Base

	COM	COL	Gr.1	Gr.2	Gr.3	Gr.4	Gr.5	Gr.6	Gr.7	Gr.8	Gr.9	Gr.10	Gr.11
U Upholstered	0	126	101	147	186	230	264	292	319	354	388	421	460
											Leather LB	LC	LD
U Upholstered	506	561	618	674	730	787	844	899	956		716	1037	1138

STHC **borough single seat, arm right facing, straight back**

Product Options

Base Style	Seat and Arm Upholstery Finish	Back Upholstery Finish	Lumbar Pillow Upholstery Finish	Base Finish
U Upholstered	Fabric Leather	Fabric Leather	Fabric Leather	Fabric Leather

Note Lumbar pillow always included on the Straight Back version
Lumbar pillows rest loose on the seat

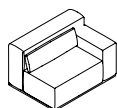

Seat

	COM	COL	Gr.1	Gr.2	Gr.3	Gr.4	Gr.5	Gr.6	Gr.7	Gr.8	Gr.9	Gr.10	Gr.11
U Upholstered	2694	2857	2947	3060	3158	3270	3355	3425	3496	3580	3663	3749	3847
											Leather LB	LC	LD
U Upholstered	3959	4099	4240	4381	4521	4661	4801	4942	5083		4374	5133	5386

Back

	COM	COL	Gr.1	Gr.2	Gr.3	Gr.4	Gr.5	Gr.6	Gr.7	Gr.8	Gr.9	Gr.10	Gr.11
U Upholstered	0	126	203	292	371	460	529	584	641	709	775	844	922
											Leather LB	LC	LD
U Upholstered	1012	1124	1236	1349	1462	1573	1685	1799	1911		1323	1947	2149

Lumbar Pillow

	COM	COL	Gr.1	Gr.2	Gr.3	Gr.4	Gr.5	Gr.6	Gr.7	Gr.8	Gr.9	Gr.10	Gr.11
U Upholstered	0	126	101	147	186	230	264	292	319	354	388	421	460
											Leather LB	LC	LD
U Upholstered	506	561	618	674	730	787	844	899	956		716	1037	1138

Base

	COM	COL	Gr.1	Gr.2	Gr.3	Gr.4	Gr.5	Gr.6	Gr.7	Gr.8	Gr.9	Gr.10	Gr.11
U Upholstered	0	126	101	147	186	230	264	292	319	354	388	421	460
											Leather LB	LC	LD
U Upholstered	506	561	618	674	730	787	844	899	956		716	1037	1138

STHD **borough single seat, arm left facing, straight back**

Product Options

Base Style	Seat and Arm Upholstery Finish	Back Upholstery Finish	Lumbar Pillow Upholstery Finish	Base Finish
U Upholstered	Fabric Leather	Fabric Leather	Fabric Leather	Fabric Leather

Note Lumbar pillow always included on the Straight Back version
Lumbar pillows rest loose on the seat

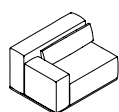

Seat

	COM	COL	Gr.1	Gr.2	Gr.3	Gr.4	Gr.5	Gr.6	Gr.7	Gr.8	Gr.9	Gr.10	Gr.11
U Upholstered	2694	2857	2947	3060	3158	3270	3355	3425	3496	3580	3663	3749	3847
											Leather LB	LC	LD
U Upholstered	3959	4099	4240	4381	4521	4661	4801	4942	5083		4374	5133	5386

Back

	COM	COL	Gr.1	Gr.2	Gr.3	Gr.4	Gr.5	Gr.6	Gr.7	Gr.8	Gr.9	Gr.10	Gr.11
U Upholstered	0	126	203	292	371	460	529	584	641	709	775	844	922
											Leather LB	LC	LD
U Upholstered	1012	1124	1236	1349	1462	1573	1685	1799	1911		1323	1947	2149

Lumbar Pillow

	COM	COL	Gr.1	Gr.2	Gr.3	Gr.4	Gr.5	Gr.6	Gr.7	Gr.8	Gr.9	Gr.10	Gr.11
U Upholstered	0	126	101	147	186	230	264	292	319	354	388	421	460
											Leather LB	LC	LD
U Upholstered	506	561	618	674	730	787	844	899	956		716	1037	1138

Base

	COM	COL	Gr.1	Gr.2	Gr.3	Gr.4	Gr.5	Gr.6	Gr.7	Gr.8	Gr.9	Gr.10	Gr.11
U Upholstered	0	126	101	147	186	230	264	292	319	354	388	421	460
											Leather LB	LC	LD
U Upholstered	506	561	618	674	730	787	844	899	956		716	1037	1138

STHJ **borough chaise, arm right facing, straight back**

Product Options

Base Style	Seat and Arm Upholstery Finish	Back Upholstery Finish	Lumbar Pillow Upholstery Finish	Base Finish
U Upholstered	Fabric Leather	Fabric Leather	Fabric Leather	Fabric Leather

Note Lumbar pillow always included on the Straight Back version
Lumbar pillows rest loose on the seat

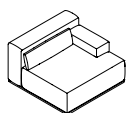

Seat

	COM	COL	Gr.1	Gr.2	Gr.3	Gr.4	Gr.5	Gr.6	Gr.7	Gr.8	Gr.9	Gr.10	Gr.11
U Upholstered	3053	3236	3306	3418	3516	3629	3714	3783	3854	3938	4022	4107	4205
											Leather LB	LC	LD
U Upholstered	4317	4458	4599	4739	4880	5019	5160	5301	5441		4753	5512	5765

Back

	COM	COL	Gr.1	Gr.2	Gr.3	Gr.4	Gr.5	Gr.6	Gr.7	Gr.8	Gr.9	Gr.10	Gr.11
U Upholstered	0	126	203	292	371	460	529	584	641	709	775	844	922
											Leather LB	LC	LD
U Upholstered	1012	1124	1236	1349	1462	1573	1685	1799	1911		1323	1947	2149

Lumbar Pillow

	COM	COL	Gr.1	Gr.2	Gr.3	Gr.4	Gr.5	Gr.6	Gr.7	Gr.8	Gr.9	Gr.10	Gr.11
U Upholstered	0	126	101	147	186	230	264	292	319	354	388	421	460
											Leather LB	LC	LD
U Upholstered	506	561	618	674	730	787	844	899	956		716	1037	1138

Base

	COM	COL	Gr.1	Gr.2	Gr.3	Gr.4	Gr.5	Gr.6	Gr.7	Gr.8	Gr.9	Gr.10	Gr.11
U Upholstered	0	126	101	147	186	230	264	292	319	354	388	421	460
											Leather LB	LC	LD
U Upholstered	506	561	618	674	730	787	844	899	956		716	1037	1138

STHK **borough chaise, arm left facing, straight back**

Product Options

Base Style	Seat and Arm Upholstery Finish	Back Upholstery Finish	Lumbar Pillow Upholstery Finish	Base Finish
U Upholstered	Fabric Leather	Fabric Leather	Fabric Leather	Fabric Leather

Note Lumbar pillow always included on the Straight Back version
Lumbar pillows rest loose on the seat

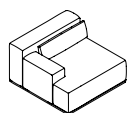

Seat

	COM	COL	Gr.1	Gr.2	Gr.3	Gr.4	Gr.5	Gr.6	Gr.7	Gr.8	Gr.9	Gr.10	Gr.11
U Upholstered	3053	3236	3306	3418	3516	3629	3714	3783	3854	3938	4022	4107	4205
											Leather LB	LC	LD
U Upholstered	4317	4458	4599	4739	4880	5019	5160	5301	5441		4753	5512	5765

Back

	COM	COL	Gr.1	Gr.2	Gr.3	Gr.4	Gr.5	Gr.6	Gr.7	Gr.8	Gr.9	Gr.10	Gr.11
U Upholstered	0	126	203	292	371	460	529	584	641	709	775	844	922
											Leather LB	LC	LD
U Upholstered	1012	1124	1236	1349	1462	1573	1685	1799	1911		1323	1947	2149

Lumbar Pillow

	COM	COL	Gr.1	Gr.2	Gr.3	Gr.4	Gr.5	Gr.6	Gr.7	Gr.8	Gr.9	Gr.10	Gr.11
U Upholstered	0	126	101	147	186	230	264	292	319	354	388	421	460
											Leather LB	LC	LD
U Upholstered	506	561	618	674	730	787	844	899	956		716	1037	1138

Base

	COM	COL	Gr.1	Gr.2	Gr.3	Gr.4	Gr.5	Gr.6	Gr.7	Gr.8	Gr.9	Gr.10	Gr.11
U Upholstered	0	126	101	147	186	230	264	292	319	354	388	421	460
											Leather LB	LC	LD
U Upholstered	506	561	618	674	730	787	844	899	956		716	1037	1138

STHL **borough single seat, 90 corner, straight back**

Product Options

Base Style	Seat and Arm Upholstery Finish	Back Upholstery Finish	Lumbar Pillow Upholstery Finish	Base Finish
U Upholstered	Fabric Leather	Fabric Leather	Fabric Leather	Fabric Leather

Note Lumbar pillow always included on the Straight Back version
Lumbar pillows rest loose on the seat

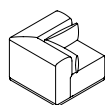

Seat

	COM	COL	Gr.1	Gr.2	Gr.3	Gr.4	Gr.5	Gr.6	Gr.7	Gr.8	Gr.9	Gr.10	Gr.11
U Upholstered	2685	2846	2811	2868	2917	2972	3015	3050	3085	3127	3170	3211	3260
											Leather LB	LC	LD
U Upholstered	3317	3387	3457	3527	3598	3668	3739	3808	3879		3605	3984	4110

Back

	COM	COL	Gr.1	Gr.2	Gr.3	Gr.4	Gr.5	Gr.6	Gr.7	Gr.8	Gr.9	Gr.10	Gr.11
U Upholstered	0	126	215	311	395	489	561	621	680	752	824	896	979
											Leather LB	LC	LD
U Upholstered	1075	1195	1313	1433	1552	1672	1791	1911	2030		1398	2044	2258

Lumbar Pillow

	COM	COL	Gr.1	Gr.2	Gr.3	Gr.4	Gr.5	Gr.6	Gr.7	Gr.8	Gr.9	Gr.10	Gr.11
U Upholstered	0	126	101	147	186	230	264	292	319	354	388	421	460
											Leather LB	LC	LD
U Upholstered	506	561	618	674	730	787	844	899	956		716	1037	1138

Base

	COM	COL	Gr.1	Gr.2	Gr.3	Gr.4	Gr.5	Gr.6	Gr.7	Gr.8	Gr.9	Gr.10	Gr.11
U Upholstered	0	126	101	147	186	230	264	292	319	354	388	421	460
											Leather LB	LC	LD
U Upholstered	506	561	618	674	730	787	844	899	956		716	1037	1138

STHW **borough single seat, 45 inside curve, straight back**

Product Options

Base Style	Seat and Arm Upholstery Finish	Back Upholstery Finish	Lumbar Pillow Upholstery Finish	Base Finish
U Upholstered	Fabric Leather	Fabric Leather	Fabric Leather	Fabric Leather

Note Lumbar pillow always included on the Straight Back version
Lumbar pillows rest loose on the seat

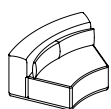

Seat

	COM	COL	Gr.1	Gr.2	Gr.3	Gr.4	Gr.5	Gr.6	Gr.7	Gr.8	Gr.9	Gr.10	Gr.11
U Upholstered	2448	2595	2600	2667	2726	2794	2844	2886	2929	2979	3030	3080	3139
											Leather LB	LC	LD
U Upholstered	3207	3291	3376	3460	3544	3629	3713	3796	3881		3505	3961	4113

Back

	COM	COL	Gr.1	Gr.2	Gr.3	Gr.4	Gr.5	Gr.6	Gr.7	Gr.8	Gr.9	Gr.10	Gr.11
U Upholstered	0	126	190	274	348	432	495	548	601	664	727	790	864
											Leather LB	LC	LD
U Upholstered	948	1054	1159	1264	1370	1475	1581	1686	1791		1247	1816	2006

Lumbar Pillow

	COM	COL	Gr.1	Gr.2	Gr.3	Gr.4	Gr.5	Gr.6	Gr.7	Gr.8	Gr.9	Gr.10	Gr.11
U Upholstered	0	126	101	147	186	230	264	292	319	354	388	421	460
											Leather LB	LC	LD
U Upholstered	506	561	618	674	730	787	844	899	956		716	1037	1138

Base

	COM	COL	Gr.1	Gr.2	Gr.3	Gr.4	Gr.5	Gr.6	Gr.7	Gr.8	Gr.9	Gr.10	Gr.11
U Upholstered	0	126	101	147	186	230	264	292	319	354	388	421	460
											Leather LB	LC	LD
U Upholstered	506	561	618	674	730	787	844	899	956		716	1037	1138

STHX **borough single seat, 60 inside curve, straight back**

Product Options

Base Style	Seat and Arm Upholstery Finish	Back Upholstery Finish	Lumbar Pillow Upholstery Finish	Base Finish
U Upholstered	Fabric Leather	Fabric Leather	Fabric Leather	Fabric Leather

Note Lumbar pillow always included on the Straight Back version
Lumbar pillows rest loose on the seat

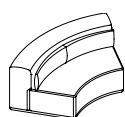

Seat

	COM	COL	Gr.1	Gr.2	Gr.3	Gr.4	Gr.5	Gr.6	Gr.7	Gr.8	Gr.9	Gr.10	Gr.11
U Upholstered	2791	2959	2981	3065	3139	3223	3286	3340	3392	3455	3519	3582	3656
											Leather LB	LC	LD
U Upholstered	3740	3846	3950	4056	4162	4266	4372	4478	4582		4097	4666	4856

Back

	COM	COL	Gr.1	Gr.2	Gr.3	Gr.4	Gr.5	Gr.6	Gr.7	Gr.8	Gr.9	Gr.10	Gr.11
U Upholstered	0	126	278	402	510	633	726	803	881	973	1066	1159	1268
											Leather LB	LC	LD
U Upholstered	1391	1546	1700	1854	2009	2164	2318	2472	2627		1778	2613	2891

Lumbar Pillow

	COM	COL	Gr.1	Gr.2	Gr.3	Gr.4	Gr.5	Gr.6	Gr.7	Gr.8	Gr.9	Gr.10	Gr.11
U Upholstered	0	126	126	183	232	288	330	365	400	443	485	526	576
											Leather LB	LC	LD
U Upholstered	632	702	773	843	913	983	1054	1124	1195		868	1247	1373

Base

	COM	COL	Gr.1	Gr.2	Gr.3	Gr.4	Gr.5	Gr.6	Gr.7	Gr.8	Gr.9	Gr.10	Gr.11
U Upholstered	0	126	101	147	186	230	264	292	319	354	388	421	460
											Leather LB	LC	LD
U Upholstered	506	561	618	674	730	787	844	899	956		716	1037	1138

STHY **borough single seat, 30 outside curve, straight back**

Product Options

Base Style	Seat and Arm Upholstery Finish	Back Upholstery Finish	Lumbar Pillow Upholstery Finish	Base Finish
U Upholstered	Fabric Leather	Fabric Leather	Fabric Leather	Fabric Leather

Note Lumbar pillow always included on the Straight Back version
Lumbar pillows rest loose on the seat

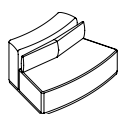

Seat

	COM	COL	Gr.1	Gr.2	Gr.3	Gr.4	Gr.5	Gr.6	Gr.7	Gr.8	Gr.9	Gr.10	Gr.11
U Upholstered	2791	2959	2981	3065	3139	3223	3286	3340	3392	3455	3519	3582	3656
											Leather LB	LC	LD
U Upholstered	3740	3846	3950	4056	4162	4266	4372	4478	4582		4097	4666	4856

Back

	COM	COL	Gr.1	Gr.2	Gr.3	Gr.4	Gr.5	Gr.6	Gr.7	Gr.8	Gr.9	Gr.10	Gr.11
U Upholstered	0	126	215	311	395	489	561	621	680	752	824	896	979
											Leather LB	LC	LD
U Upholstered	1075	1195	1313	1433	1552	1672	1791	1911	2030		1398	2044	2258

Lumbar Pillow

	COM	COL	Gr.1	Gr.2	Gr.3	Gr.4	Gr.5	Gr.6	Gr.7	Gr.8	Gr.9	Gr.10	Gr.11
U Upholstered	0	126	101	147	186	230	264	292	319	354	388	421	460
											Leather LB	LC	LD
U Upholstered	506	561	618	674	730	787	844	899	956		716	1037	1138

Base

	COM	COL	Gr.1	Gr.2	Gr.3	Gr.4	Gr.5	Gr.6	Gr.7	Gr.8	Gr.9	Gr.10	Gr.11
U Upholstered	0	126	101	147	186	230	264	292	319	354	388	421	460
											Leather LB	LC	LD
U Upholstered	506	561	618	674	730	787	844	899	956		716	1037	1138

STHZ **borough single seat, 22.5 outside curve, straight back**

Product Options

Base Style	Seat and Arm Upholstery Finish	Back Upholstery Finish	Lumbar Pillow Upholstery Finish	Base Finish
U Upholstered	Fabric Leather	Fabric Leather	Fabric Leather	Fabric Leather

Note Lumbar pillow always included on the Straight Back version
Lumbar pillows rest loose on the seat

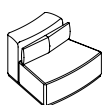

Seat

	COM	COL	Gr.1	Gr.2	Gr.3	Gr.4	Gr.5	Gr.6	Gr.7	Gr.8	Gr.9	Gr.10	Gr.11
U Upholstered	2448	2595	2638	2722	2796	2880	2943	2996	3049	3112	3175	3238	3313
											Leather LB	LC	LD
U Upholstered	3396	3502	3607	3713	3818	3923	4029	4134	4239		3733	4302	4492

Back

	COM	COL	Gr.1	Gr.2	Gr.3	Gr.4	Gr.5	Gr.6	Gr.7	Gr.8	Gr.9	Gr.10	Gr.11
U Upholstered	0	126	215	311	395	489	561	621	680	752	824	896	979
											Leather LB	LC	LD
U Upholstered	1075	1195	1313	1433	1552	1672	1791	1911	2030		1398	2044	2258

Lumbar Pillow

	COM	COL	Gr.1	Gr.2	Gr.3	Gr.4	Gr.5	Gr.6	Gr.7	Gr.8	Gr.9	Gr.10	Gr.11
U Upholstered	0	126	101	147	186	230	264	292	319	354	388	421	460
											Leather LB	LC	LD
U Upholstered	506	561	618	674	730	787	844	899	956		716	1037	1138

Base

	COM	COL	Gr.1	Gr.2	Gr.3	Gr.4	Gr.5	Gr.6	Gr.7	Gr.8	Gr.9	Gr.10	Gr.11
U Upholstered	0	126	101	147	186	230	264	292	319	354	388	421	460
											Leather LB	LC	LD
U Upholstered	506	561	618	674	730	787	844	899	956		716	1037	1138

STHM **borough bench, rectangle**

Product Options

Base Style	Seat Upholstery Finish	Base Finish
U Upholstered	Fabric Leather	Fabric Leather

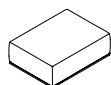

		Seat												
		COM	COL	Gr.1	Gr.2	Gr.3	Gr.4	Gr.5	Gr.6	Gr.7	Gr.8	Gr.9	Gr.10	Gr.11
U Upholstered		1686	1788	1889	1978	2057	2147	2215	2270	2327	2395	2461	2529	2608
		Gr.12	Gr.13	Gr.14	Gr.15	Gr.16	Gr.17	Gr.18	Gr.19	Gr.20	Leather			
U Upholstered		2698	2810	2922	3035	3147	3260	3372	3485	3597	LB	LC	LD	
											3002	3608	3811	
		Base												
		COM	COL	Gr.1	Gr.2	Gr.3	Gr.4	Gr.5	Gr.6	Gr.7	Gr.8	Gr.9	Gr.10	Gr.11
U Upholstered		0	126	101	147	186	230	264	292	319	354	388	421	460
		Gr.12	Gr.13	Gr.14	Gr.15	Gr.16	Gr.17	Gr.18	Gr.19	Gr.20	Leather			
U Upholstered		506	561	618	674	730	787	844	899	956	LB	LC	LD	
											716	1037	1138	

STHN borough bench, square

Product Options

Base Style	Seat Upholstery Finish	Base Finish
U Upholstered	Fabric Leather	Fabric Leather



		Seat												
		COM	COL	Gr.1	Gr.2	Gr.3	Gr.4	Gr.5	Gr.6	Gr.7	Gr.8	Gr.9	Gr.10	Gr.11
U Upholstered		1608	1705	1784	1864	1933	2011	2070	2119	2168	2227	2287	2346	2414
												Leather		
		Gr.12	Gr.13	Gr.14	Gr.15	Gr.16	Gr.17	Gr.18	Gr.19	Gr.20	LB	LC	LD	
U Upholstered		2493	2591	2689	2788	2886	2984	3083	3182	3280	2766	3298	3475	
		Base												
		COM	COL	Gr.1	Gr.2	Gr.3	Gr.4	Gr.5	Gr.6	Gr.7	Gr.8	Gr.9	Gr.10	Gr.11
U Upholstered		0	126	101	147	186	230	264	292	319	354	388	421	460
												Leather		
		Gr.12	Gr.13	Gr.14	Gr.15	Gr.16	Gr.17	Gr.18	Gr.19	Gr.20	LB	LC	LD	
U Upholstered		506	561	618	674	730	787	844	899	956	716	1037	1138	

STHR **borough rounded bench, right facing**

Product Options

Base Style	Seat Upholstery Finish	Base Finish
U Upholstered	Fabric Leather	Fabric Leather



		Seat												
		COM	COL	Gr.1	Gr.2	Gr.3	Gr.4	Gr.5	Gr.6	Gr.7	Gr.8	Gr.9	Gr.10	Gr.11
U Upholstered		2221	2355	2524	2660	2777	2912	3014	3098	3183	3283	3384	3486	3604
		Gr.12	Gr.13	Gr.14	Gr.15	Gr.16	Gr.17	Gr.18	Gr.19	Gr.20	Leather			
U Upholstered		3739	3908	4076	4244	4413	4581	4750	4919	5087	LB	LC	LD	
											4176	5087	5390	
		Base												
		COM	COL	Gr.1	Gr.2	Gr.3	Gr.4	Gr.5	Gr.6	Gr.7	Gr.8	Gr.9	Gr.10	Gr.11
U Upholstered		0	126	101	147	186	230	264	292	319	354	388	421	460
		Gr.12	Gr.13	Gr.14	Gr.15	Gr.16	Gr.17	Gr.18	Gr.19	Gr.20	Leather			
U Upholstered		506	561	618	674	730	787	844	899	956	LB	LC	LD	
											716	1037	1138	

STHQ **borough rounded bench, left facing**

Product Options

Base Style	Seat Upholstery Finish	Base Finish
U Upholstered	Fabric Leather	Fabric Leather



		Seat												
		COM	COL	Gr.1	Gr.2	Gr.3	Gr.4	Gr.5	Gr.6	Gr.7	Gr.8	Gr.9	Gr.10	Gr.11
U Upholstered		2221	2355	2524	2660	2777	2912	3014	3098	3183	3283	3384	3486	3604
		Gr.12	Gr.13	Gr.14	Gr.15	Gr.16	Gr.17	Gr.18	Gr.19	Gr.20	Leather			
U Upholstered		3739	3908	4076	4244	4413	4581	4750	4919	5087	LB	LC	LD	
											4176	5087	5390	
		Base												
		COM	COL	Gr.1	Gr.2	Gr.3	Gr.4	Gr.5	Gr.6	Gr.7	Gr.8	Gr.9	Gr.10	Gr.11
U Upholstered		0	126	101	147	186	230	264	292	319	354	388	421	460
		Gr.12	Gr.13	Gr.14	Gr.15	Gr.16	Gr.17	Gr.18	Gr.19	Gr.20	Leather			
U Upholstered		506	561	618	674	730	787	844	899	956	LB	LC	LD	
											716	1037	1138	

STHS borough 45 inside bench

Product Options

Base Style	Seat Upholstery Finish	Base Finish
U Upholstered	Fabric Leather	Fabric Leather

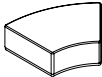

		Seat												
		COM	COL	Gr.1	Gr.2	Gr.3	Gr.4	Gr.5	Gr.6	Gr.7	Gr.8	Gr.9	Gr.10	Gr.11
U Upholstered		1943	2060	2133	2217	2291	2375	2438	2492	2544	2607	2671	2734	2808
												Leather		
		Gr.12	Gr.13	Gr.14	Gr.15	Gr.16	Gr.17	Gr.18	Gr.19	Gr.20	LB	LC	LD	
U Upholstered		2892	2998	3102	3208	3314	3418	3524	3630	3734	3198	3767	3957	
		Base												
		COM	COL	Gr.1	Gr.2	Gr.3	Gr.4	Gr.5	Gr.6	Gr.7	Gr.8	Gr.9	Gr.10	Gr.11
U Upholstered		0	126	101	147	186	230	264	292	319	354	388	421	460
												Leather		
		Gr.12	Gr.13	Gr.14	Gr.15	Gr.16	Gr.17	Gr.18	Gr.19	Gr.20	LB	LC	LD	
U Upholstered		506	561	618	674	730	787	844	899	956	716	1037	1138	

STHT borough 60 inside bench

Product Options

Base Style	Seat Upholstery Finish	Base Finish
U Upholstered	Fabric Leather	Fabric Leather

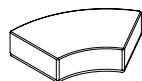

		Seat												
		COM	COL	Gr.1	Gr.2	Gr.3	Gr.4	Gr.5	Gr.6	Gr.7	Gr.8	Gr.9	Gr.10	Gr.11
U Upholstered		2461	2609	2714	2826	2924	3037	3122	3192	3262	3346	3430	3515	3613
												Leather		
		Gr.12	Gr.13	Gr.14	Gr.15	Gr.16	Gr.17	Gr.18	Gr.19	Gr.20	LB	LC	LD	
U Upholstered		3726	3866	4007	4147	4288	4428	4568	4709	4849	4127	4885	5138	
		Base												
		COM	COL	Gr.1	Gr.2	Gr.3	Gr.4	Gr.5	Gr.6	Gr.7	Gr.8	Gr.9	Gr.10	Gr.11
U Upholstered		0	126	101	147	186	230	264	292	319	354	388	421	460
												Leather		
		Gr.12	Gr.13	Gr.14	Gr.15	Gr.16	Gr.17	Gr.18	Gr.19	Gr.20	LB	LC	LD	
U Upholstered		506	561	618	674	730	787	844	899	956	716	1037	1138	

STHU borough 30 outside bench

Product Options

Base Style	Seat Upholstery Finish	Base Finish
U Upholstered	Fabric Leather	Fabric Leather

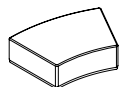

		Seat												
		COM	COL	Gr.1	Gr.2	Gr.3	Gr.4	Gr.5	Gr.6	Gr.7	Gr.8	Gr.9	Gr.10	Gr.11
U Upholstered		2461	2609	2714	2826	2924	3037	3122	3192	3262	3346	3430	3515	3613
		Gr.12	Gr.13	Gr.14	Gr.15	Gr.16	Gr.17	Gr.18	Gr.19	Gr.20	Leather			
U Upholstered		3726	3866	4007	4147	4288	4428	4568	4709	4849	LB	LC	LD	
											4127	4885	5138	
		Base												
		COM	COL	Gr.1	Gr.2	Gr.3	Gr.4	Gr.5	Gr.6	Gr.7	Gr.8	Gr.9	Gr.10	Gr.11
U Upholstered		0	126	101	147	186	230	264	292	319	354	388	421	460
		Gr.12	Gr.13	Gr.14	Gr.15	Gr.16	Gr.17	Gr.18	Gr.19	Gr.20	Leather			
U Upholstered		506	561	618	674	730	787	844	899	956	LB	LC	LD	
											716	1037	1138	

STHV borough 22.5 outside bench

Product Options

Base Style	Seat Upholstery Finish	Base Finish
U Upholstered	Fabric Leather	Fabric Leather

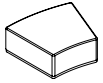

		Seat												
		COM	COL	Gr.1	Gr.2	Gr.3	Gr.4	Gr.5	Gr.6	Gr.7	Gr.8	Gr.9	Gr.10	Gr.11
U Upholstered		1943	2060	2158	2254	2338	2433	2505	2565	2624	2696	2768	2839	2922
												Leather		
		Gr.12	Gr.13	Gr.14	Gr.15	Gr.16	Gr.17	Gr.18	Gr.19	Gr.20	LB	LC	LD	
U Upholstered		3018	3138	3257	3377	3496	3616	3734	3854	3973	3414	3995	4210	
		Base												
		COM	COL	Gr.1	Gr.2	Gr.3	Gr.4	Gr.5	Gr.6	Gr.7	Gr.8	Gr.9	Gr.10	Gr.11
U Upholstered		0	126	101	147	186	230	264	292	319	354	388	421	460
												Leather		
		Gr.12	Gr.13	Gr.14	Gr.15	Gr.16	Gr.17	Gr.18	Gr.19	Gr.20	LB	LC	LD	
U Upholstered		506	561	618	674	730	787	844	899	956	716	1037	1138	

STHPA **borough pillow, large rectangular**

Product Options

Pillow Upholstery Finish

Fabric
Leather



Price

COM	COL	Gr.1	Gr.2	Gr.3	Gr.4	Gr.5	Gr.6	Gr.7	Gr.8	Gr.9	Gr.10	Gr.11
437	463	538	583	622	667	701	729	758	791	825	859	898
Gr.12	Gr.13	Gr.14	Gr.15	Gr.16	Gr.17	Gr.18	Gr.19	Gr.20	Leather			
943	1000	1055	1112	1167	1224	1280	1336	1392	LB	LC	LD	
									1070	1373	1475	

STHPB **borough pillow, lumbar, long**

Product Options

Pillow Upholstery Finish

Fabric
Leather

Note Sized for back version with no arms



Price

COM	COL	Gr.1	Gr.2	Gr.3	Gr.4	Gr.5	Gr.6	Gr.7	Gr.8	Gr.9	Gr.10	Gr.11
407	431	508	553	592	637	670	699	727	761	795	828	868
Gr.12	Gr.13	Gr.14	Gr.15	Gr.16	Gr.17	Gr.18	Gr.19	Gr.20	Leather			
912	969	1025	1081	1137	1194	1249	1306	1361	LB	LC	LD	
									1038	1341	1442	

STHPC **borough pillow, lumbar short**

Product Options

Pillow Upholstery Finish

Fabric
Leather

Note Sized for back version with one arm



Price

COM	COL	Gr.1	Gr.2	Gr.3	Gr.4	Gr.5	Gr.6	Gr.7	Gr.8	Gr.9	Gr.10	Gr.11
376	399	477	522	561	606	640	668	697	730	764	798	837
Gr.12	Gr.13	Gr.14	Gr.15	Gr.16	Gr.17	Gr.18	Gr.19	Gr.20	Leather			
882	938	994	1051	1106	1163	1219	1275	1331	LB	LC	LD	
									1006	1309	1410	