

**Worksurfaces**

XWR XWD XWT XWCT XWMQ

Available Edge Trim Style, if applicable: 6 Straight Trim, 9 Flintwood Flat Trim

Available Corner Detail, if applicable: S Standard (for trim style 6 or 9), R Radius (for trim style 6 only)

**Supports**

**Legs**

Standard C-Leg (C) T-Leg (T) Arched C-Leg (C) T-Leg (T) C-Leg (C) T-Leg (T) Slender C-Leg (C) T-Leg (T) C-Leg (C) T-Leg (T) Post Thesis Standard Height (29) ADA Height (33)

F29 Fixed Height XSLD ASR Height Adjust. – Standard Range XSLA F29 Fixed Height ASR Height Adjust. – Standard Range XSLS F29 Fixed Height ASR Height Adjust. – Standard Range XSPS

Available Casters/Levelers if applicable: L Levelers C Casters

Available Corner Detail, if applicable: S Standard (for trim style 6 or 9), R Radius (for trim style 6 only)

Available Casters/Levelers if applicable: L Leveler C Caster

C Casters F/P/S Levelers – Glides XSPA

**Tables**

**Flip-Top Tables**

Standard Legs C-Leg (C) T-Leg (T) Arched Legs C-Leg (C) only Slender Legs C-Leg (C) T-Leg (T) Kupp Legs Thesis Legs

XFTFD XFTFA XFTFS XFTFK XTFAS XTFAG

N Non Magnetic M Magnetic

Available Casters only Casters Available Glass Finish, if applicable Back-Painted

Available Corner Detail, if applicable S Standard (for trim style 6 or 9) R Radius (for trim style 6 only)

**Folding Tables**

Standard Legs C-Leg (C) T-Leg (T) Arched Legs C-Leg (C) T-Leg (T) Slender Legs C-Leg (C) T-Leg (T) Lightweight Folding Tables Standard Legs C-Leg (C) T-Leg (T) Arched Legs C-Leg (C) T-Leg (T) Slender Legs C-Leg (C) T-Leg (T)

XTFSD XTFSA XTFSS XTFLD XTFLA XTFLS

Available Casters/Levelers if applicable: L Levelers C Casters

**Mobile Trolley** High Tables Single-Sided 36" or 42" h Thesis Legs Team 29" h 36" or 42" h 29" h 36" or 42" h Double-Sided 29" h 36" or 42" h

XTMT XTHAS XTHAD XTHS XTHD

F Full-Height – No Cable Pass-Through G Full-Height – With Cable Pass-Through W Wall-Access H Half-Height

This symbol is used for products designed for people with reduced mobility (Products comply with Americans with Disabilities Act (ADA))

Available Edge Trim Style, if applicable: 6 Straight Trim 9 Flintwood Flat Trim

**Instructor**

**Instructor Work.** Thesis Leg (A)

XTPW

Available Corner Detail, if applicable: S Standard (for trim style 6 or 9) R Radius (for trim style 6 only)

**Instructor Desk** XTPD

**Instructor Desk with Fixed Lectern** XTPT

**Lectern Podium** M Mobile (Shown) S Stationary XTPL

**Table Accessories**

**Modesty Panels**

For Worksurfaces only Solid Metal For Flip-Top Tables only Solid Metal For Kupp Flip-Top Table only Solid Smooth Felt

C With Built-In Cable Tray W Without Built-In Cable Tray C With Built-In Cable Tray W Without Built-In Cable Tray Without Built-In Cable Tray

XCMS XCMM XCMSF XCMMF XCMSK XCMZK

Available Embossed Patterns if applicable: 201 Square Solo 401 Dot Solo

**Table Screens**

Fabric – Back Glass – Back Fabric – Lateral Glass – Lateral

XCSBF XCSBG XCSLF XCSLG

G Non Magnetic Glass

Thesis Leg only

XCLDC XCLPF XCHK XCHW XCALE XCALC XCFTM XCDEK

F Felt Glide P PTFE Glide S Steel Glide

Available Glass Finish, if applicable Back-Painted

**Collaboration Tools**

G Glass – Non Magnetic – Front Configuration XCMBM

Back Configuration E Felt G Glass – Non Magnetic M Glass – Magnetic – Front Configuration



Library Tables

Library Tables

Single-Sided

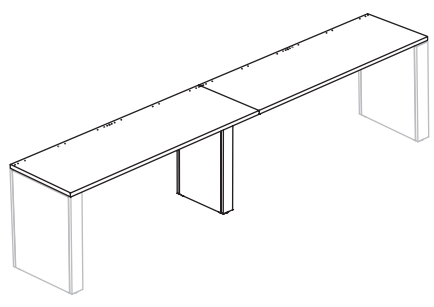

XL TSS

Double-Sided

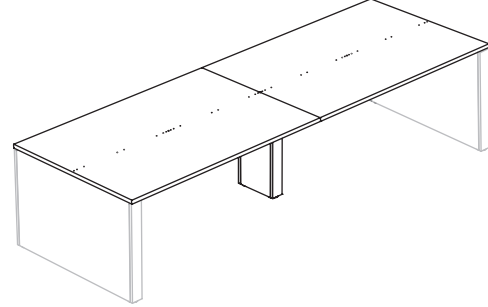

XL TDS

ADA Extension for Library Tables

Single-Sided

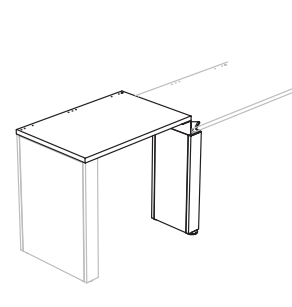

XL TSA

Double-Sided

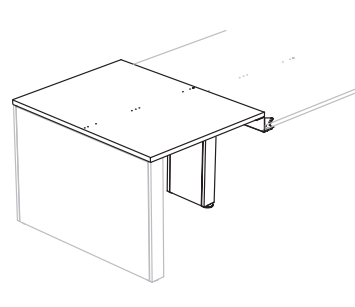

XL TDA

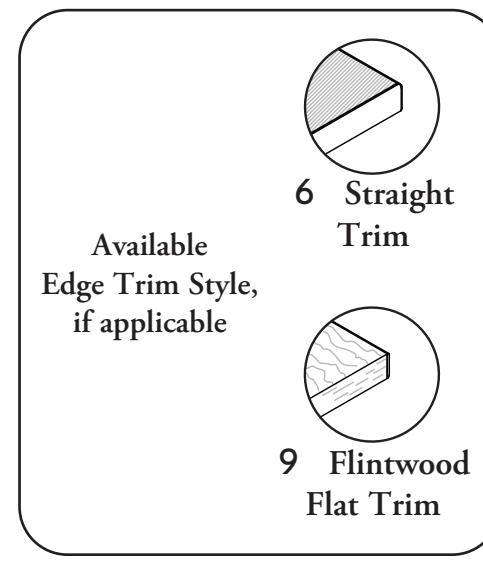

Supports for Library Tables

Square Post Legs

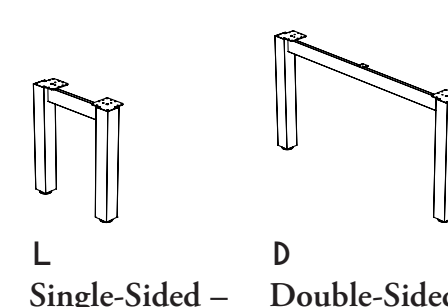

L Single-Sided – Left Handed  
R Right Handed  
XL BQ

D Double-Sided

End Gable – Solid

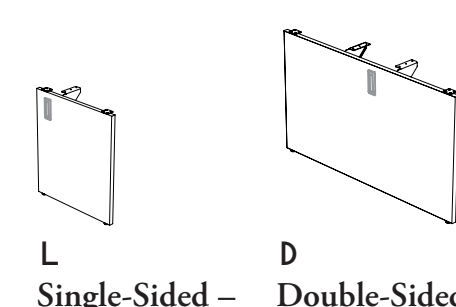

L Single-Sided – Left Handed  
R Right Handed  
XL BGD

D Double-Sided

Rectangular Base

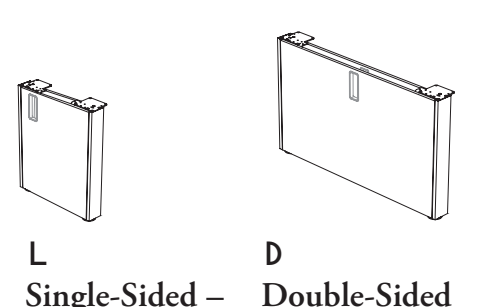

L Single-Sided – Left Handed  
R Right Handed  
XL BR

D Double-Sided

Carrel End Screens

Solid

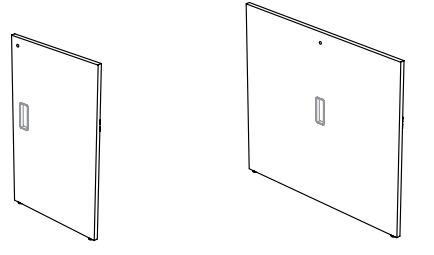

L Single-Sided – Left Handed  
R Right Handed  
XL CFS

D Double-Sided

Glass

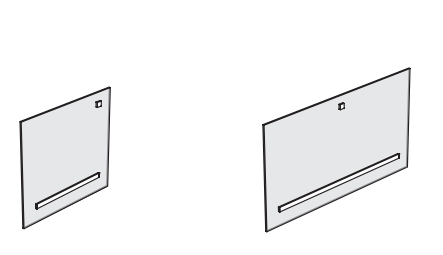

L Single-Sided – Left Handed  
R Right Handed  
XL CEG

D Double-Sided

Solid

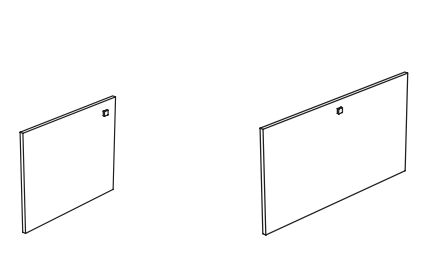

L Single-Sided – Left Handed  
R Right Handed  
XL CES

D Double-Sided



This symbol is used for products designed for people with reduced mobility (Products comply with Americans with Disabilities Act (ADA))



Carrel Dividers

Single-Sided

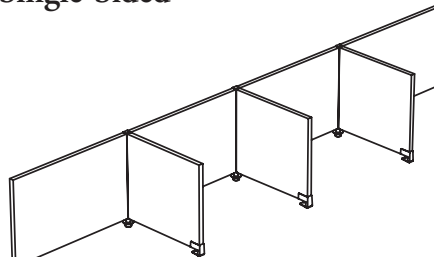

SS Solid  
XL CS

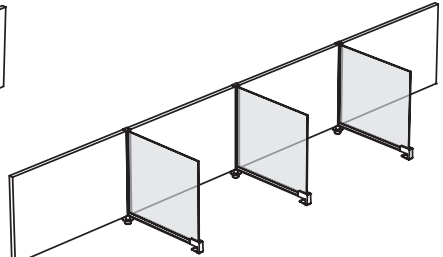

SG Solid with Glass Return

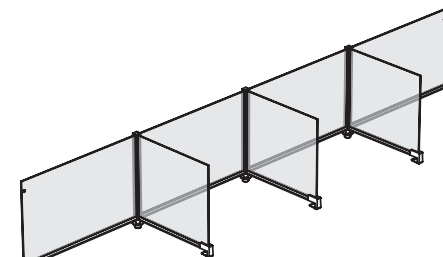

GG Glass

ADA – Single-Sided

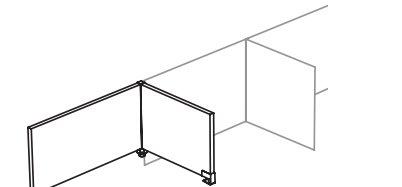

SS Solid  
XL CSA

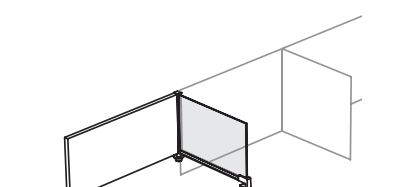

SG Solid with Glass Return

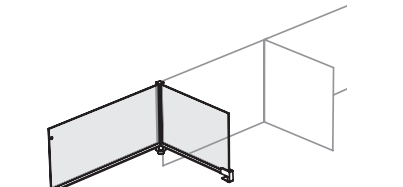

GG Glass

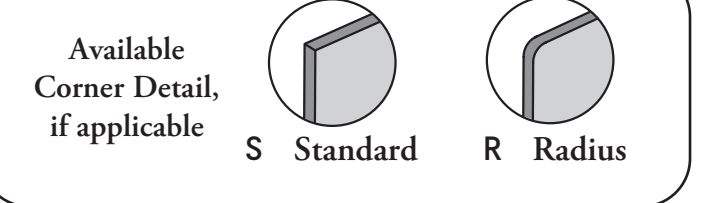

Double-Sided

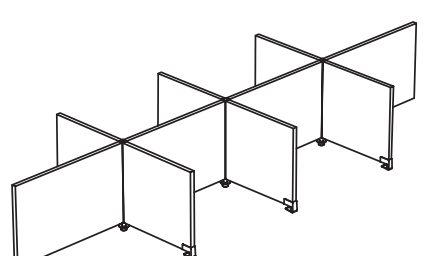

SS Solid  
XL CD

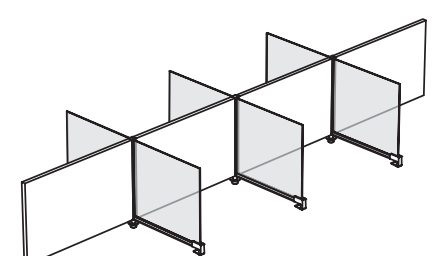

SG Solid with Glass Return

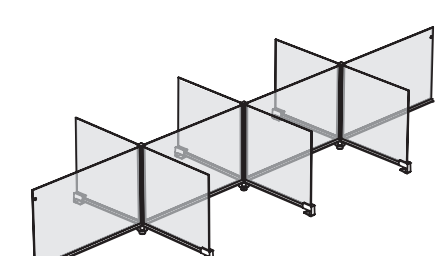

GG Glass

ADA – Double-Sided

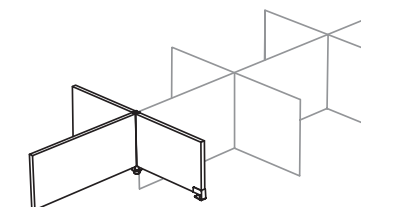

SS Solid  
XL CDA

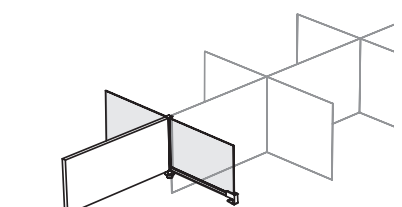

SG Solid with Glass Return

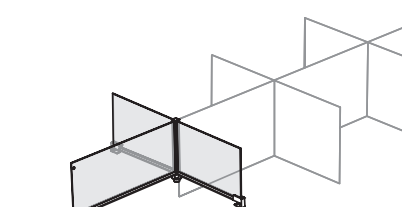

GG Glass

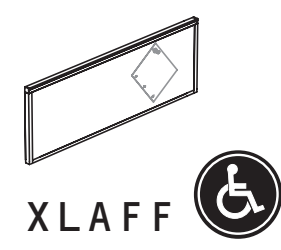
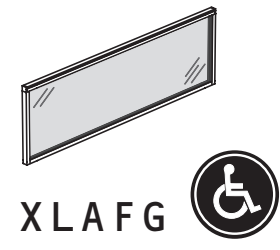
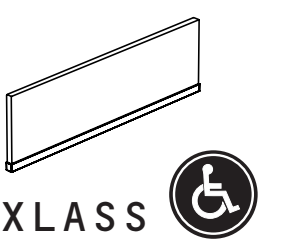
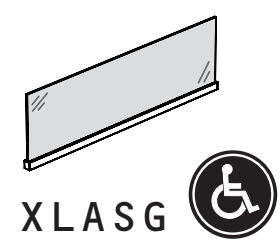
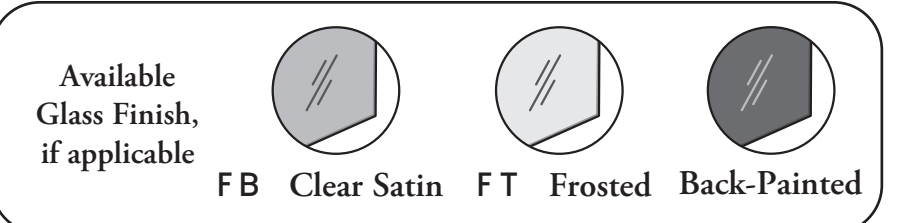

Lighting, Electrics & Communications

Power Modules

Plug-In (A)

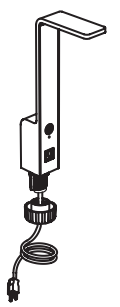

XL LRL

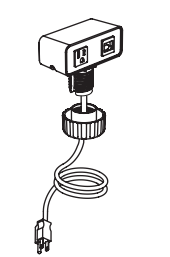

D101N to D200N Dual Config.  
XPPC

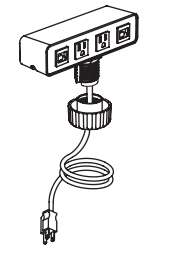

Q202N to Q320S Quad Config.  
XPPDC

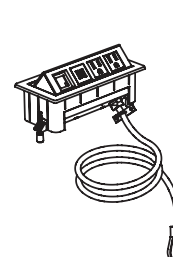

XPEPP

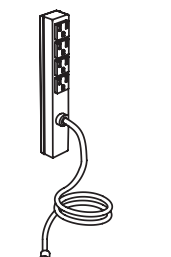

XPCB

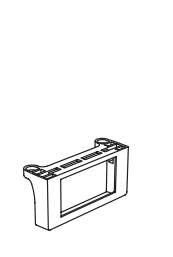

XPEPB

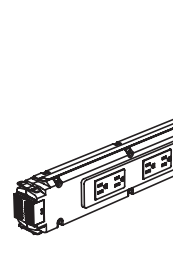

XPEPET

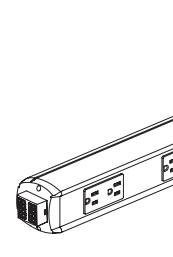

XPEPH

Power Harnesses



XPEPB

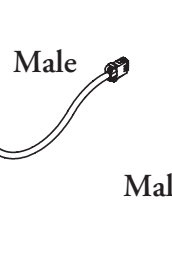

XPEBF

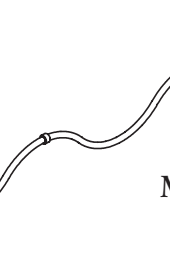

XPEHE

Power Kits – Library Tables

4 Outlets

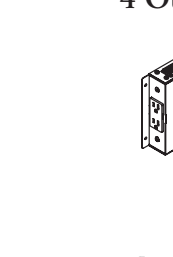

Base Feed/Power/Extension Harnesses  
XPLKP

8 Outlets

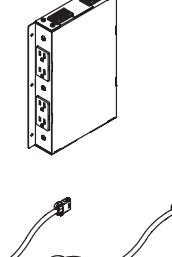

ADA Extension  
XPLKA

4 Outlets

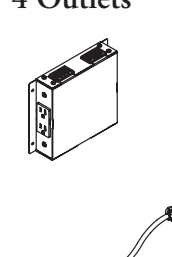

Base Feed Extension Harness  
XPLBF

Wire Managements for Legs or Bases

Arched Leg

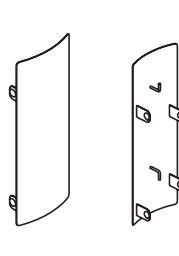

XPWLA

Slender Leg

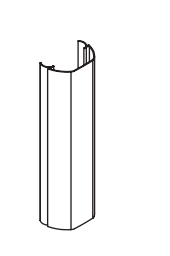

XPWLS

Thesis Leg

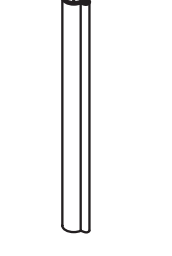

XPWPA

Bases

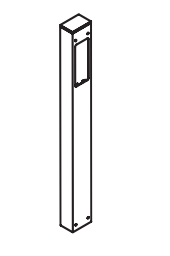

XPWPP

Bases

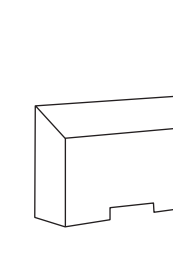

XPWFB

Wire Managements for Tables

Bases

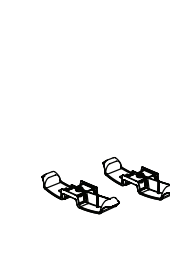

XPWC

Bases

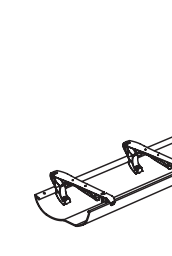

XPWET

Bases

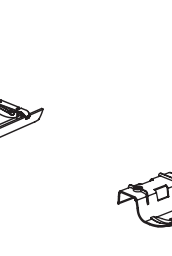

XPWCT

Bases



XPWGX

Bases



XPWPC