

# lockers

UNDERSTANDING LOCKERS . . . . .	684
LOCKER BASICS . . . . .	687
PLANNING WITH LOCKERS . . . . .	692
UNDERSTANDING RECYCLING/DISPOSAL UNITS . . . . .	699
RECYCLING/DISPOSAL UNIT BASICS . . . . .	701
PLANNING WITH RECYCLING/DISPOSAL UNITS. . . . .	704
ANGLED FOOT SHARING APPLICATIONS – ELEVATED LOCKERS & RECYCLING/DISPOSAL UNITS . . . . .	708
DIGITAL LOCK DETAILS . . . . .	712
DIGITAL LOCK KEY BASICS . . . . .	713
PULL, STANDARD LOCK & DIGITAL LOCK POSITIONS – LOCKERS & RECYCLING/DISPOSAL UNITS . . . . .	714
LOCK CHART – LOCKERS & RECYCLING/DISPOSAL UNITS . . . .	716
GRAIN DIRECTION – LOCKERS & RECYCLING/DISPOSAL UNITS . . .	718



# lockers (continued)

NUMBER & SYMBOL IDENTIFICATION BASICS . . . . . 719

PLANNING WITH NUMBER & SYMBOL IDENTIFICATIONS . . . . . 721

# understanding lockers

Expansion Cityline Lockers provide a variety of locker options for both personal and common storage and are available with doors or open, in Standard and Elevated profiles.

- When applicable, they can be specified Dual (D) or Triple (T) Configuration
- When applicable, the lockers are handed, except for Common Full Doors Lockers (JLFSD, JLFSG, JLESF or JLESG)
- Most closed storage come with optional standard locks and keys set or digital locks. Refer to Lock Chart at the end of this section for details
- Seven Interior configurations (C, D, H, N, O, S, T) can be specified. Refer on page 695 for more details

## standard profile (with levelers)

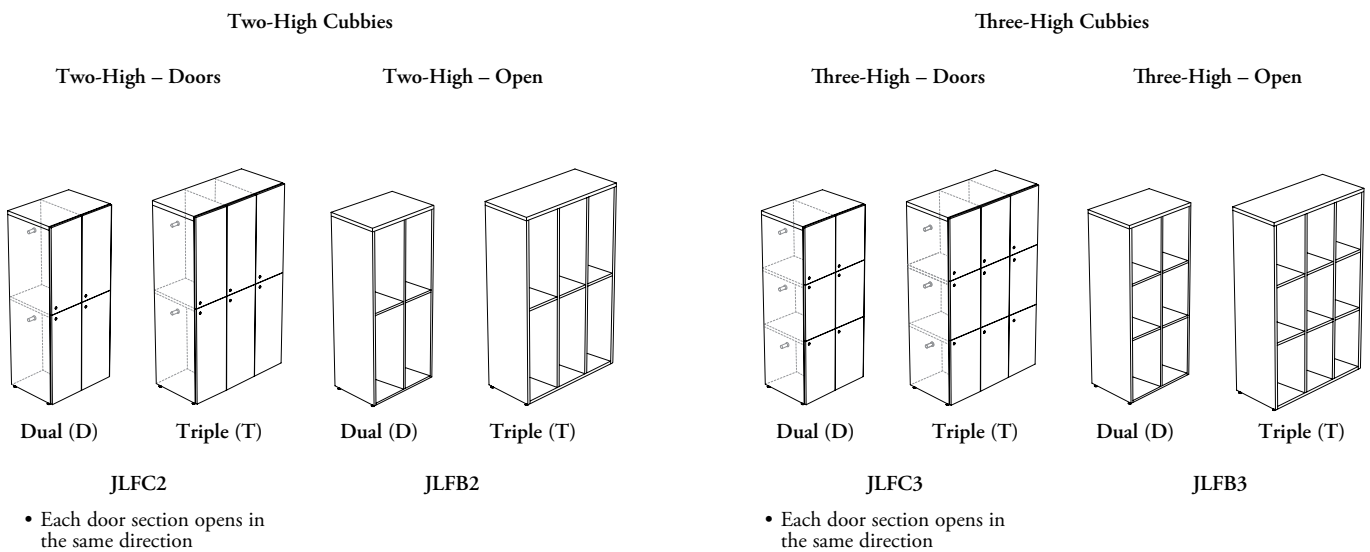
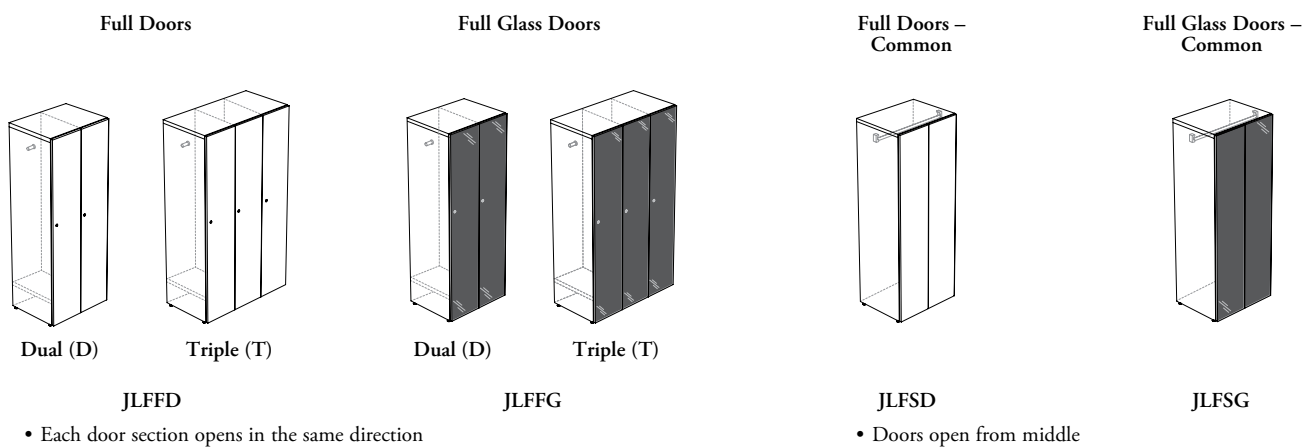

## levelers

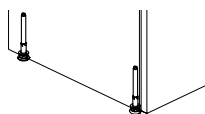

Standard Lockers offer a 3" leveling range

# understanding lockers (continued)

## elevated profile (with angled foot)

Full Doors

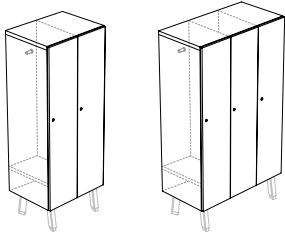

Dual (D) Triple (T)

JLEFD

Full Glass Doors

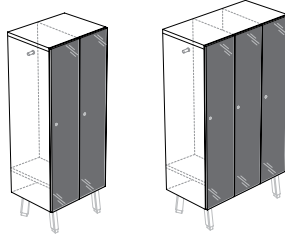

Dual (D) Triple (T)

JLEFG

Full Doors – Common

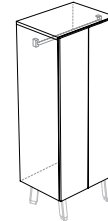

JLESD

Full Glass Doors – Common

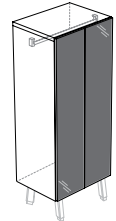

JLESG

- Each door section opens in the same direction

- Doors open from middle

Two-High Cubbies

Two-High – Doors

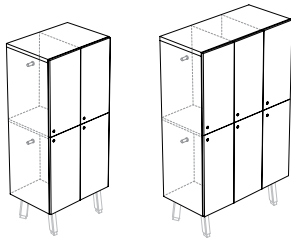

Dual (D) Triple (T)

JLEC2

Two-High – Open

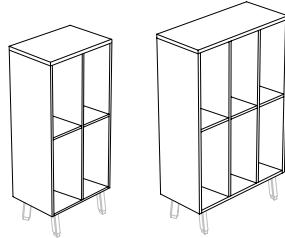

Dual (D) Triple (T)

JLEB2

Three-High Cubbies

Three-High – Doors

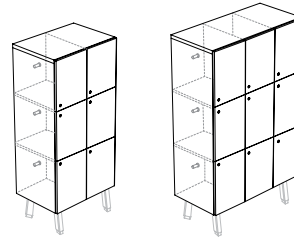

Dual (D) Triple (T)

JLEC3

Three-High – Open

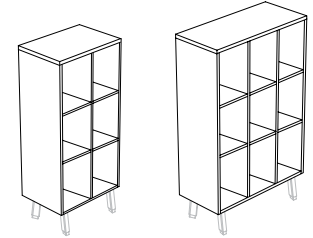

Dual (D) Triple (T)

JLEB3

- Each door section opens in the same direction

- Each door section opens in the same direction

## angled foot kit



- Angled Foot Kit for Elevated Storage (JLEFK) is **not** included with Elevated Lockers and must be specified separately. Their position can vary. Refer on page 708 for more details
- Leveling range of 3" (-3/16", +2 13/16") for lockers with Angled Foot Kit

# understanding lockers (continued)

- All doors come with an individual lock when specified. **Not applicable with Common Full Doors Lockers**
- Door Swing Left (L) or Right (R) is determined by location of the hinges.
- No Identification (N), Number Ready (R) or Symbol Ready (S) can be specified on solid or metal doors

## solid door

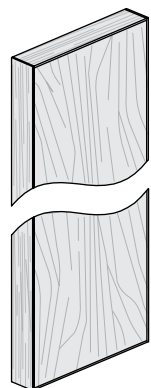

When specified, Number Ready (R) or Symbol Ready (S)  
Comes with pre-drilled holes for Locker Number or Common Locker Symbol

Doors specified without Pull come with Touch-Latch Opening

Solid (S)/No Lock (N)



Solid (S)/Lock (K or R)



Solid Doors specified with pull or Digilock Lock come with Self-Closing Hinges

Solid with Pull (T)/No Lock (N)

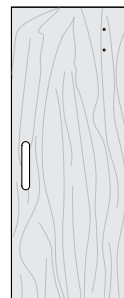

Solid with Pull (T)/Lock (K or R)



Solid with Digital Lock (U)/Digital Lock Assigned (A)



## metal door

Thin Metal Front

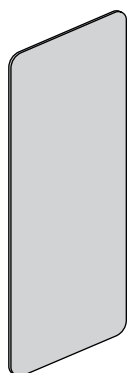

When specified, Number Ready (R) or Symbol Ready (S)

Reinforcing Bar

Metal (M)/No Lock (N)

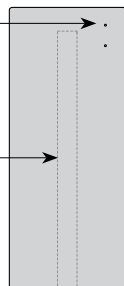

Metal (M)/Lock (K or R)

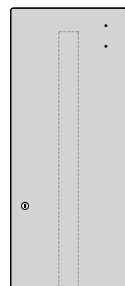

Metal Doors specified with pull or Digilock Lock come with Soft-Closing Hinges

Metal with Pull (N)/No Lock (N)

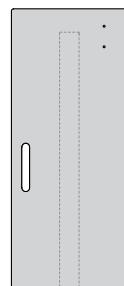

Metal with Pull (N)/Lock (K or R)

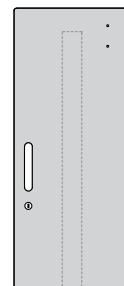

Metal with Digital Lock (O)/Digital Lock Assigned (A)

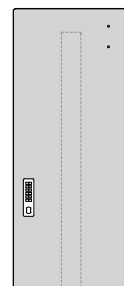

## glass door

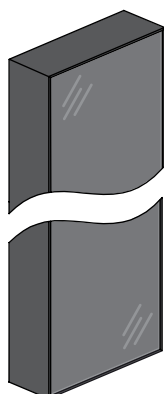

Number Ready (R) or Symbol Ready (S) cannot be specified

No Lock (N)



Standard Lock (K or R)



### Pull Style available:

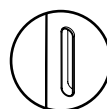

- Cityline Recessed (C)
  - Vertical Position
  - Lockers come with 1 pull on each door

### Lock Styles available:



Standard Locks (K or R)



Digital Lock Assigned (A)  
For more details on Digital Lock, refer on page 712

### Locker Number or Common Locker Symbol available:



JLANN



JLASS

Not included with Lockers and must be specified separately. Refer to page 719 for more details

# locker basics

Lockers provide personal or common storage, with side hooks, coat rod or shelf storage in a variety of configurations.

- Standard and Elevated **cannot** be linked together
- Can be linked to each other or to Recycling/Disposal Units
- The Interior Configuration can vary depending of the locker style. Refer on page 695 for more details

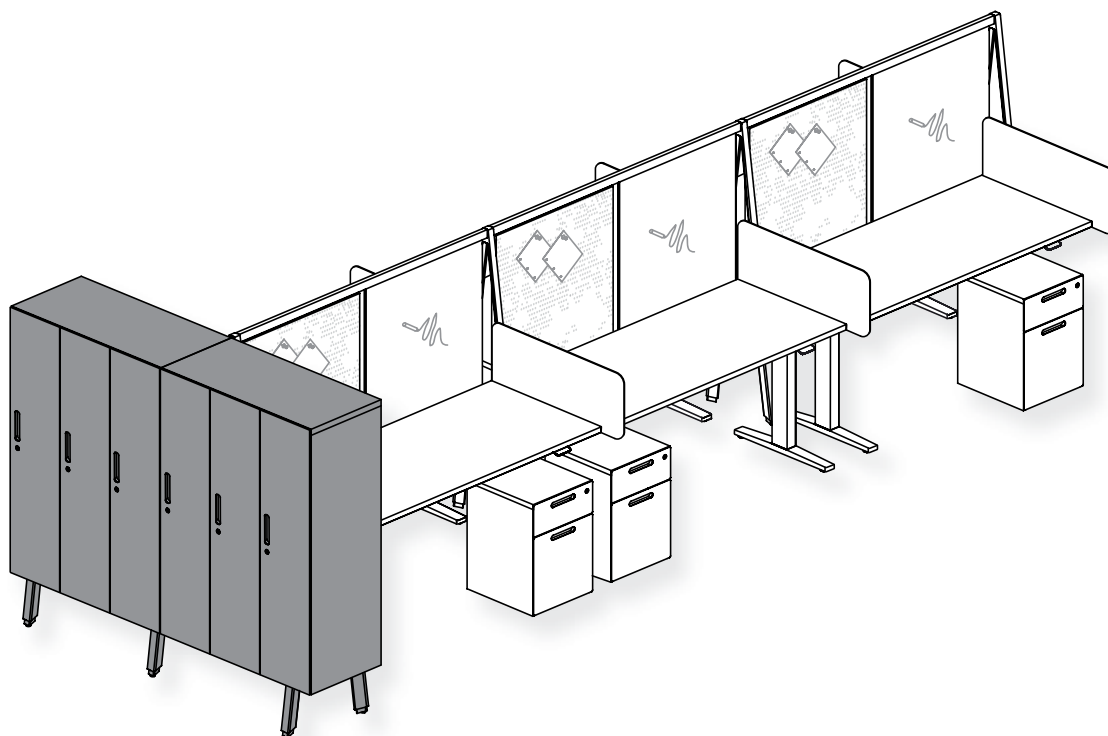

## Finishes

**Metal Door Front Finishes\***: Foundation, Mica and Accent

**Laminate Door Front\*\* Finishes**: Source Laminate and Foundation Laminate

\* Laminate Front Doors are 11/16" thick

Edge Trim Finishes: Edge Trim Colors (Laminate Front only)

Door Frame Finishes: Foundation, Mica and Accent

Glass Door Finishes: Back-Painted\*\*

\*\* Glass Doors are 5/32" (4 mm) tempered glass

Pull Finishes (if applicable): Foundation, Mica and Accent

Case Finishes: Source Laminate

Fixed or Adjustable Shelf(ves)\*\*\* Finishes: Source Laminate or match with Case Finish

\*\*\* Shelves are 11/16" thick

Side Hooks Finish: Platinum Coordinate

Coat Rod Finish: Chrome

## locker basics (continued)

- Triple Lockers with 18" doors width are **not** offered in all heights. Refer individual product pages

### Locker – Full Doors (JLFFD), Locker – Full Glass Doors (JLFFG) Elevated Locker – Full Doors (JLEFD) or Elevated Locker – Full Glass Doors (JLEFG)

- Lockers have two or three full height doors
- Front styles: Metal (M), Solid (S), Metal with Pull (N), Solid with Pull (T) Metal with Digital Lock (O) or Solid with Digital Lock (U). Full Glass Doors Lockers (JLFFG or JLEFG) are also available
- Datum heights of 42", 51", 57" or 66"
- Depths: 18" or 24"
- Door widths: 12" or 15"
- Configurations: Dual (D) or Triple (T)
- Door Swing directions Left (L) or Right (R) (Shown) are available
- Number Ready (R) Identification or No Identification (N) (Shown) can be specified on door fronts. **Not** available with Full Glass Doors (JLFFG or JLEFG)
- Interior Configuration Side Hooks (H), Side Hooks & Shelf (O) or Side Hooks & Shelves (T) are available
- When specified, Cityline Recessed (C) pull style is only available with Metal with Pull (N) or Solid with Pull (T). **Not** available with Full Glass Doors (JLFFG or JLEFG)
- Standard (Shown) or Digital Locks can be specified. Digital Lock option is **not** available with Full Glass Doors (JLFFG or JLEFG)

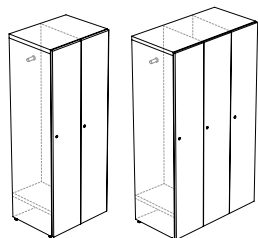

JLFFD

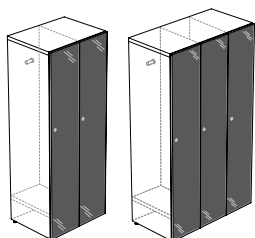

JLFFG

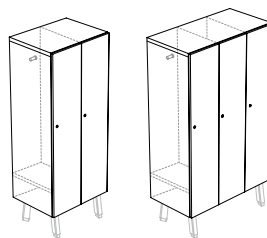

JLEFD

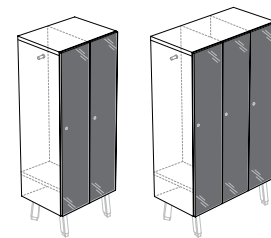

JLEFG

### Locker – Two-High Cubby (JLFC2) or Elevated Locker – Two-High Cubby (JLEC2)

- Lockers with Two-High Cubby have four or six cubbies per unit
- Front styles: Metal (M), Solid (S), Metal with Pull (N), Solid with Pull (T) Metal with Digital Lock (O) or Solid with Digital Lock (U)
- Datum heights of 42", 51", 57" or 66"
- Depths: 18" or 24"
- Door widths: 15" or 18"
- Configurations: Dual (D) or Triple (T)
- Door Swing directions Left (L) or Right (R) (Shown) are available
- Number Ready (R) Identification or No Identification (N) (Shown) can be specified on door fronts
- Interior Configuration Side Hooks (H), Shelf (S) or No Accessory (N) are available
- When specified, Cityline Recessed (C) pull style is only available with Metal with Pull (N) or Solid with Pull (T)
- Standard (Shown) or Digital Locks can be specified

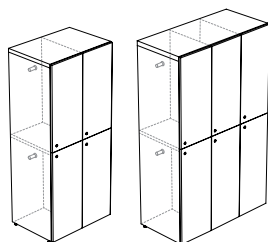

JLFC2

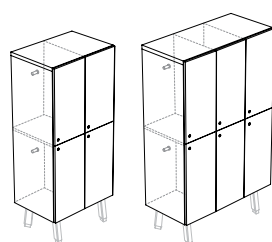

JLEC2



# locker basics (continued)

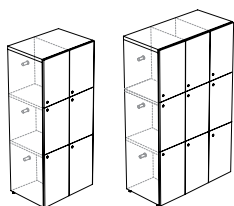

JLFC3

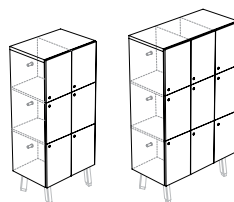

JLEC3

**Locker – Three-High Cubby (JLFC3) or Elevated Locker – Three-High Cubby (JLEC3)**

- Lockers with Three-High Cubby have six or nine cubbies per unit
- Front styles: Metal (M), Solid (S), Metal with Pull (N), Solid with Pull (T) Metal with Digital Lock (O) or Solid with Digital Lock (U)
- Datum heights of 57" or 66"
- Depths: 18" or 24"
- Door widths: 15" or 18"
- Configurations: Dual (D) or Triple (T)
- Door Swing directions Left (L) or Right (R) (Shown) are available
- Number Ready (R) Identification or No Identification (N) (Shown) can be specified on door fronts
- Interior Configuration Side Hooks (H), Shelf (S) or No Accessory (N) are available
- When specified, Cityline Recessed (C) pull style is only available with Metal with Pull (N) or Solid with Pull (T)
- Standard (Shown) or Digital Locks can be specified

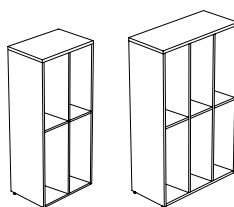

JLFB2

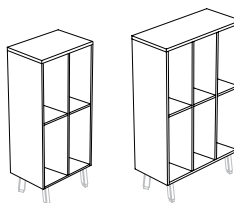

JLEB2

**Open Locker – Two-High Cubby (JLFB2) or Elevated Open Locker – Two-High Cubby (JLEB2)**

- Lockers with Two-High Cubby have four or six open cubbies per unit
- Datum heights of 42", 51", 57" or 66"
- Depths: 18" or 24"
- Open section widths: 15" or 18"
- Configurations: Dual (D) or Triple (T)
- Interior Configuration Shelf (S) or No Accessory (N) (Shown) are available

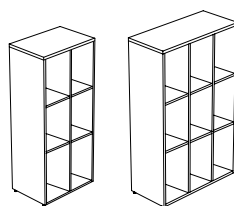

JLFB3

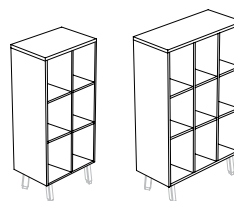

JLEB3

**Open Locker – Three-High Cubby (JLFB3) or Elevated Open Locker – Three-High Cubby (JLEB3)**

- Lockers with Three-High Cubby have six or nine open cubbies per unit
- Datum heights of 57" or 66"
- Depths: 18" or 24"
- Open section widths: 15" or 18"
- Configurations: Dual (D) or Triple (T)
- Only No Accessory (N) Interior Configuration is available

## locker basics (continued)

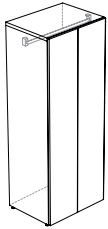

### **Common Locker – Full Doors (JLFSD)**

- Lockers have two full height solid doors
- Front styles: Metal (M), Solid (S), Metal with Pull (N) or Solid with Pull (T)
- Datum heights of 51", 57" or 66"
- Depth: 24"
- Widths: 24", 30", 36"
- Symbol Ready (R) Identification or No Identification (N) (Shown) can be specified on door front
- Interior Configuration Coat Rod (C) or Coat Rod & Shelf (D) are available
- Cityline Recessed (C) pull style is only available with Metal with Pull (N) or Solid with Pull (T)

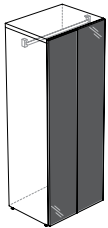

### **Common Locker – Full Glass Doors (JLFSG)**

- Lockers have two full height glass doors
- Datum heights of 51", 57" or 66"
- Depth: 24"
- Widths: 24", 30", 36"
- Interior Configuration Coat Rod (C) or Coat Rod & Shelf (D) are available

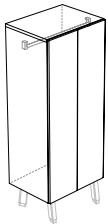

### **Elevated Common Locker – Full Doors (JLES D)**

- Lockers have two full height solid doors
- Front styles: Metal (M), Solid (S), Metal with Pull (N) or Solid with Pull (T)
- Datum heights of 57" or 66"
- Depth: 24"
- Widths: 24", 30", 36"
- Symbol Ready (R) Identification or No Identification (N) (Shown) can be specified on door front
- Only Interior Configuration Coat Rod (C) is available
- Cityline Recessed (C) pull style is only available with Metal with Pull (N) or Solid with Pull (T)

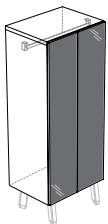

### **Elevated Common Locker – Full Glass Doors (JLES G)**

- Lockers have two full height glass doors
- Datum heights of 57" or 66"
- Depth: 24"
- Widths: 24", 30", 36"
- Only Interior Configuration Coat Rod (C) is available



# planning with lockers

The following outlines the door and opening heights for all Lockers. When specified, the pull and lock height varies depending on the number of doors on the unit.

## door openings

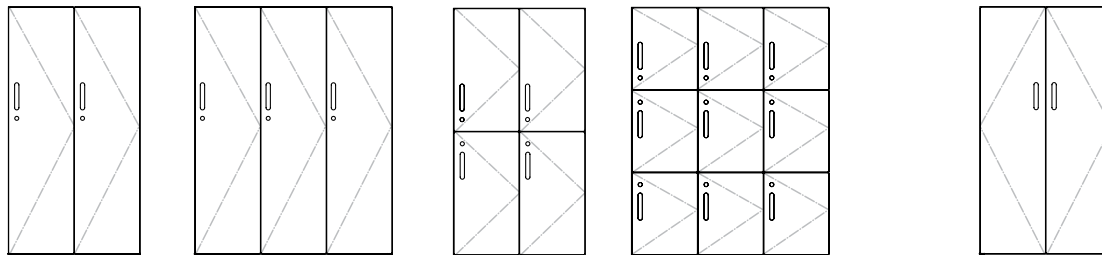

**Full Doors, Full Glass Doors, Two-High Cubbies or Three-High Cubbies Lockers – Dual or Triple – Standard or Elevated**

- All sections open in the same direction
- Door Swing – Left or Door Swing – Right Orientation can be specified

**Full Doors or Full Glass Doors Common Lockers – Standard or Elevated**

- Will open from middle

## door heights and overall opening heights – standard lockers

- All interior heights are equal
- The Interior Configuration is not illustrated, refer on page 695 for more details

42" datum height

51" datum height

Interior compartment dimensions without accessory – Lockers

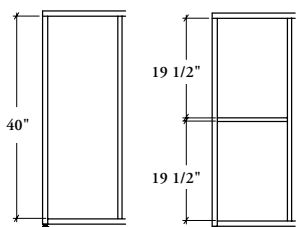

Inside locker full doors

Inside two-high Cubby or Open Cubby

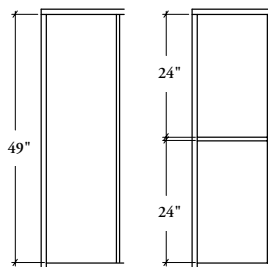

Inside locker full doors

Inside two-high Cubby or Open Cubby

57" datum height

Interior compartment dimensions without accessory – Lockers

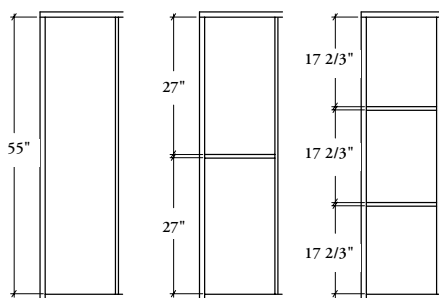

Inside locker full doors

Inside two-high Cubby or Open Cubby

Inside three-high Cubby or Open Cubby

# planning with lockers (continued)

## door heights and overall opening heights – standard lockers (continued)

### 66" datum height

Interior compartment dimensions without accessory – Lockers

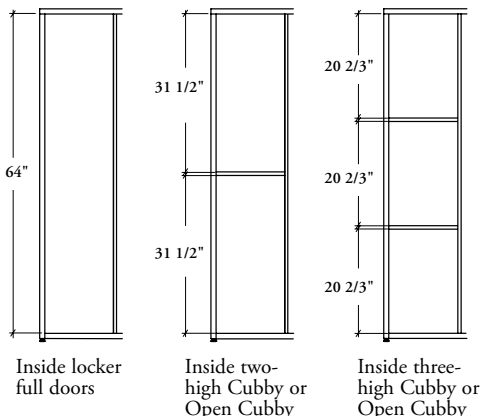

### 51", 57" & 66" datum heights

Interior compartment dimensions without accessory – Standard Common Lockers

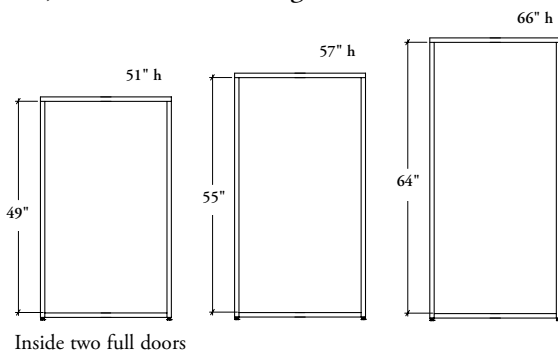

## door heights and overall opening heights – elevated lockers

### 42" datum height

Interior compartment dimensions without accessory – Elevated Lockers

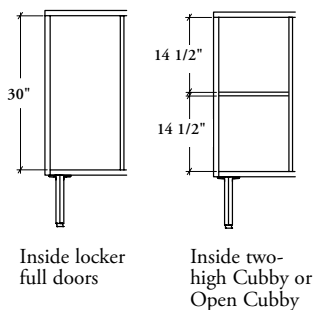

### 51" datum height

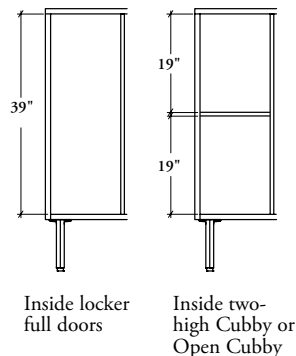

# planning with lockers (continued)

door heights and overall opening heights – elevated lockers (continued)

## 57" datum height

Interior compartment dimensions without accessory – Elevated Lockers

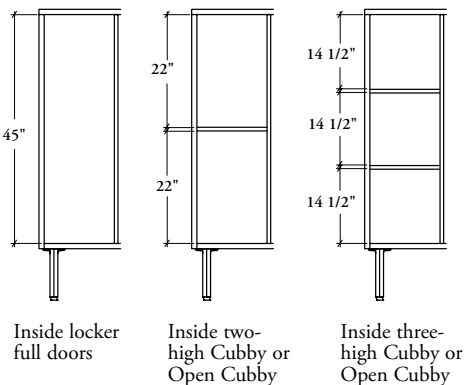

## 66" datum height

Interior compartment dimensions without accessory – Elevated Lockers

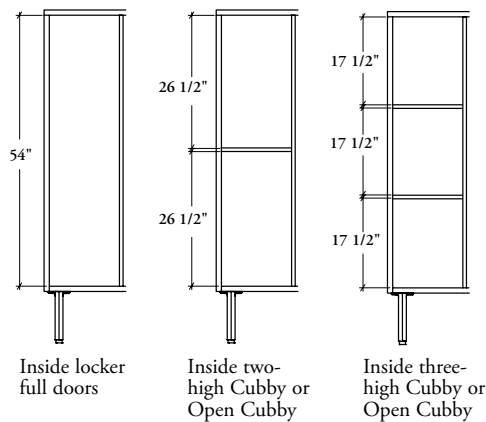

## 57" & 66" datum heights

Interior compartment dimensions without accessory – Elevated Common Lockers

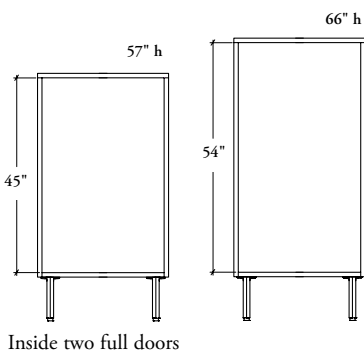

# planning with lockers (continued)

The following outlines the side hooks and/or shelf(ves) heights for all Lockers.

- All dual or triple locker sections have the same specified accessories
- For Overall Opening Heights, refer on page 692 for more details

## interior configurations

Eight interior configurations are available:

**1**

### No Accessory (N)

- Without Side Hooks and/or Shelf(ves)

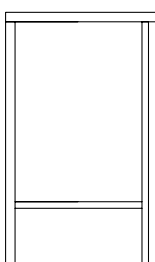

**2**

### Side Hooks (H)

- Two Side Hooks positioned on top of each side of each section

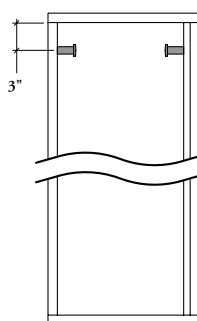

**3**

### Side Hooks & Shelf (O)

- Two Side Hooks and one Shelf
- Are user reconfigurable without tool:

- Side Hooks can be placed on top and Shelf at the bottom of section

Bottom shelf is adjustable in 1 1/4" increments from 6" to 12 1/4"

#### OR

- Shelf can be placed on top and Side Hooks under the Shelf

Fixed Shelf is positioned in 8" from top

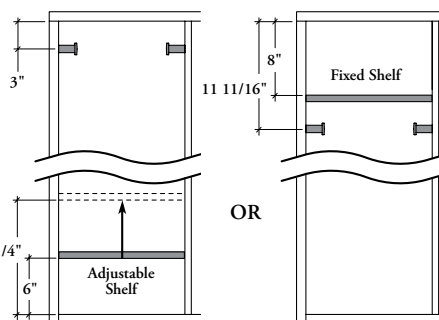

**4**

### Side Hooks & Shelves (T)

- Two Shelves and two Side Hooks
- Fixed Shelf is positioned in 8" from top

#### AND

- Bottom shelf is adjustable in 1 1/4" increments from 6" to 12 1/4"

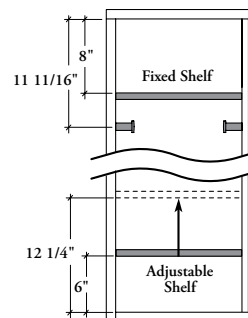

**5**

### Shelf (S)

- One Shelf per closed sections
- Shelf is fully adjustable in 1 1/4" increments, from 6" from bottom to 6" from top

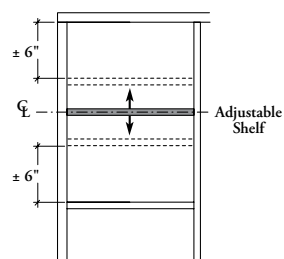

**6**

### Shelf (S) – Open Locker Two-High Cubbies

- One Shelf per open sections
- Are user reconfigurable without tools:
  - One Adjustable Shelf with three fixed positions using proportion: 1/3, 1/2, 2/3

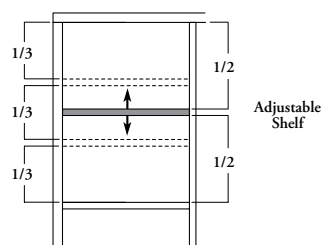

**7**

### Coat Rod (C)

- One Coat Rod only
- Positioned on top of Common Lockers

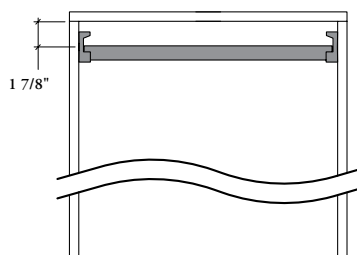

**8**

### Coat Rod & Shelf (D)

- One Coat Rod and one Shelf
- Fixed Shelf is positioned in 8" from the top

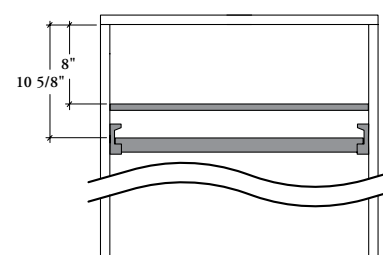

## planning with lockers (continued)

The following should be considered when planning with Expansion Cityline Lockers.

Expansion Cityline Lockers are freestanding units. They **do not** need to be anchored to anything. Therefore they can be used against a building wall, at the end of a workstation or as space division in the middle of open space

### against a wall

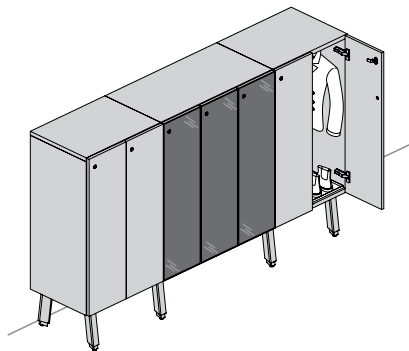

Against a wall application is ideal to create lockers outside of workstation area

### against a workstation

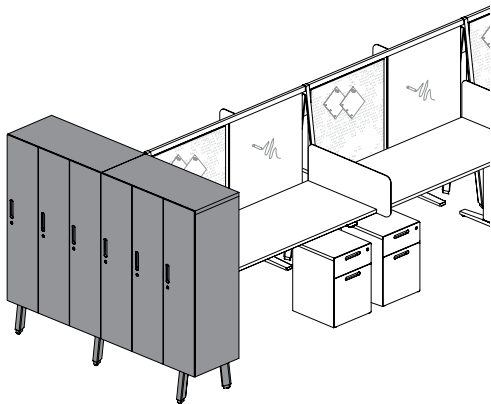

Against a workstation application allows the users to drop personal items before going to the workstation. Can also act as a space division between corridor and workstations

### middle of the space

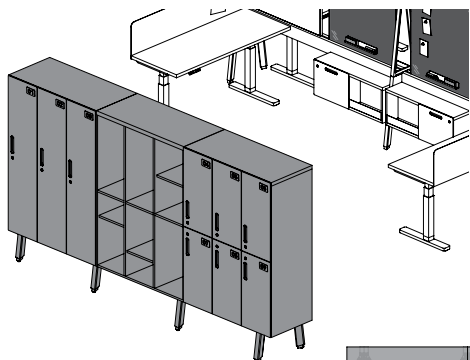

Lockers in middle of the space help to break up areas to divide teams or collaborative areas

#### Other positions available:

- Can also be place side-by-side (linear run) with fronts in opposite directions (offset)



- Can also be place back-to-back. Each side are independant and **not** linked together



- Can be place side-by-side (linear run) with fronts in the same direction





# planning with lockers (continued)

## standard lockers with elevated lockers

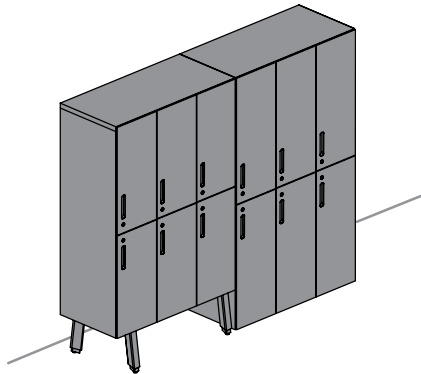

Standard Lockers with Levelers **cannot** be linked with Elevated Lockers

## lockers with recycling/disposal units

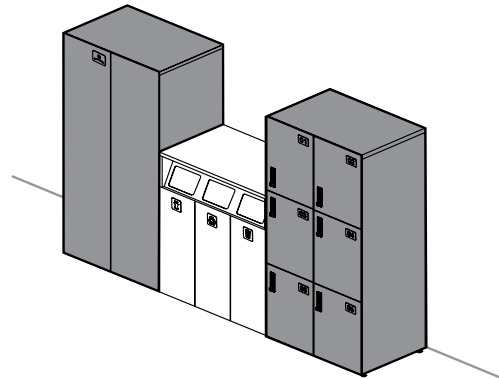

Lockers, Common Lockers and Recycling/Disposal Units can be used alone or combined together to create the desired layout

## linking standard lockers

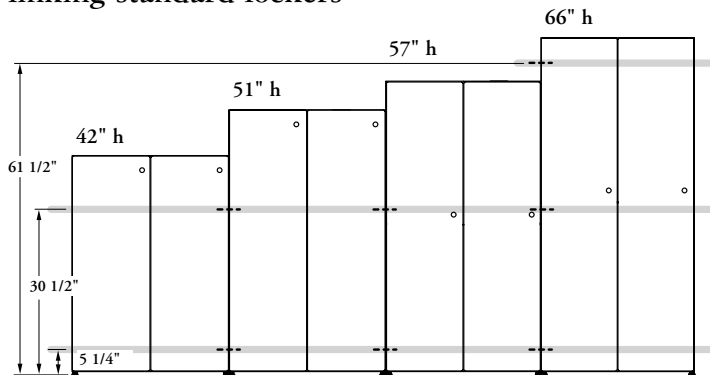

Lockers of different heights with the same depth can be linked to each other

## linking elevated lockers

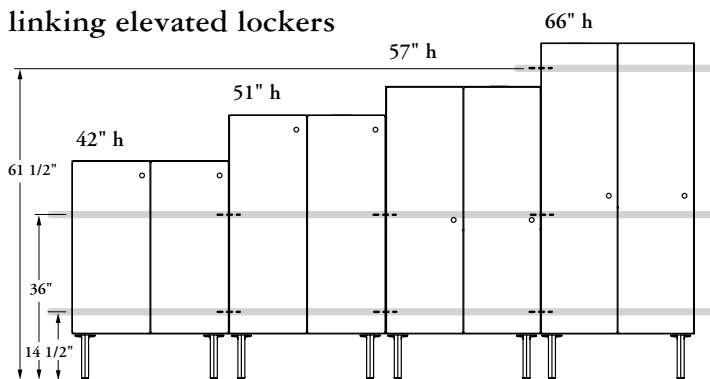

Elevated Lockers of different heights with the same depth can be linked to each other

# planning with lockers (continued)

## minimum lockers/recycling/disposal units span

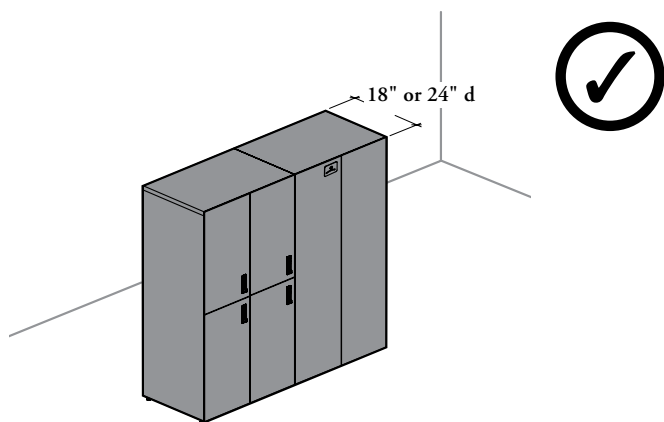

No restriction for Standard Lockers with Levelers

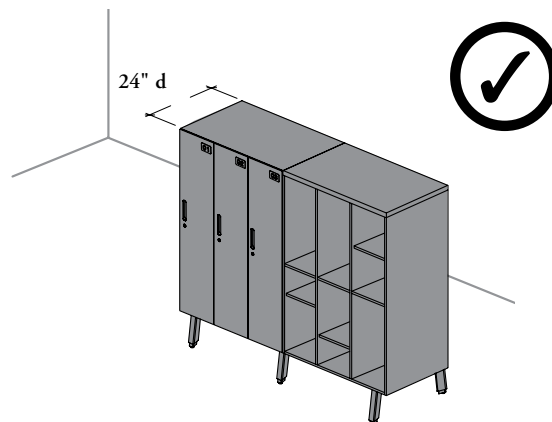

No restriction for 24" deep Elevated Lockers

Special considerations must be taken when 18" deep Elevated Lockers or Elevated Recycling/Disposal Units are specified

No minimum span in the following applications:

- Against a building (Shown)
- Middle of the space : Back-to-Back

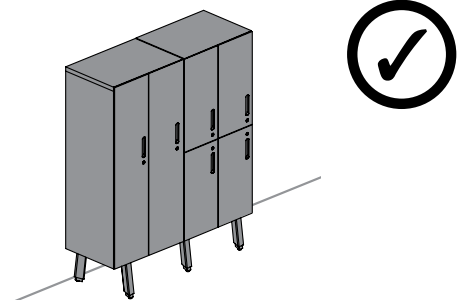

Minimum span in the following applications:

- Middle of the space : Single-Sided (one direction) (Shown)
- Middle of the space : Single-Sided (two direction - offset)
- Against a workstation

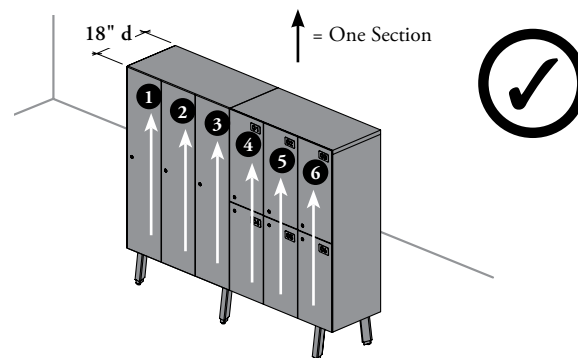

Elevated Lockers or Elevated Recycling/Disposal Units of the same height must totalize the equivalent of minimum 6 doors/open section side by side

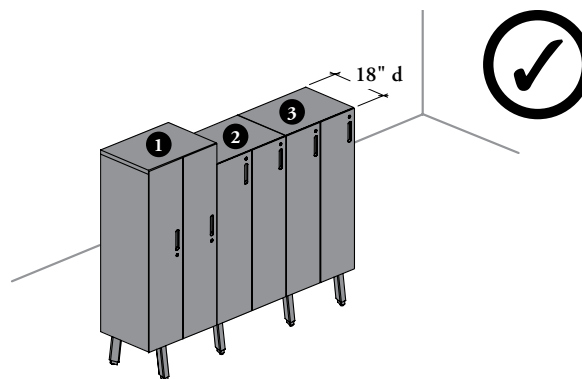
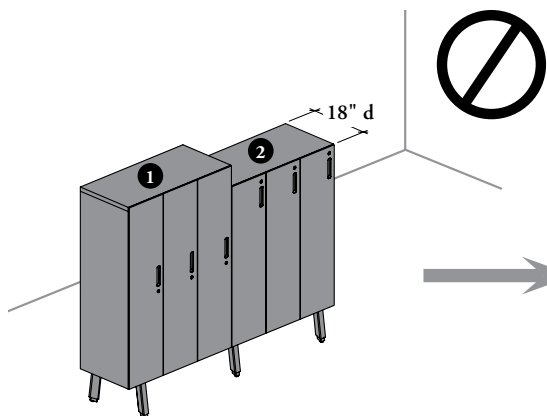

Elevated Lockers or Elevated Recycling/Disposal Units of different heights must totalize a minimum of three storage

# understanding recycling/disposal units

Recycling/Disposal Units are also available in a variety of widths and configurations. They combine recycling/waste bins with or without enclosed storage with shelves.

- All units are offered to match with Teknion standard datum height of 42"
- Metal (M) or Solid Front Style (S) can be specified
- Door fronts have **no** pull and can be handled with the fingertips from the top of the door

## standard profile (with levelers)

Recycling/Disposal Units (JLFRU)

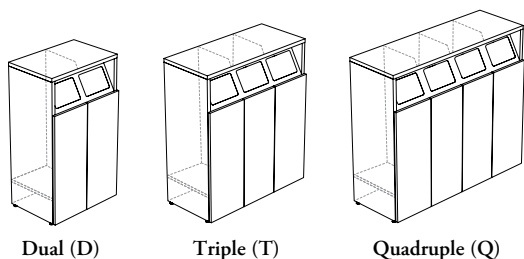

Dual (D)

Triple (T)

Quadruple (Q)

## levelers

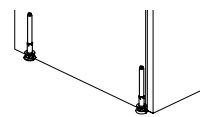

Standard profil has a 3" leveling range

Recycling/Disposal Units with Storage (JLFRS)

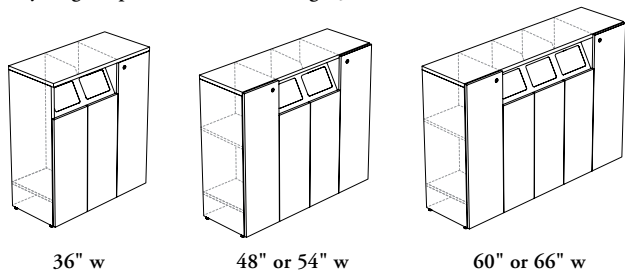

36" w

48" or 54" w

60" or 66" w

## elevated profile (with angled foot)

Elevated Recycling/Disposal Units (JLERU)

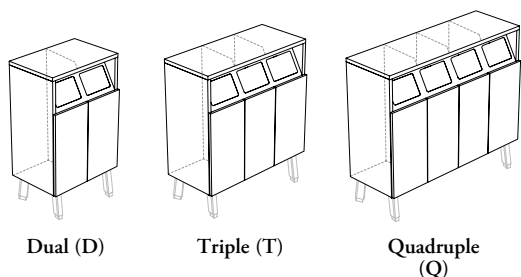

Dual (D)

Triple (T)

Quadruple (Q)

## angled foot kit



- Angled Foot Kit for Elevated Storage (JLEFK) are **not** included with Recycling/Disposal Units and must be specified separately. Their positions can vary. Refer on page 708 for more details
- Leveling range of 3" (-3/16", +2 13/16") for units with Angled Foot Kit

# understanding recycling/disposal units (continued)

- When specified, only Storage Doors come with individual lock (waste/recycling section **cannot** be locked)
- No Pulls and Digital Locks are offered
- Only 36" wide Recycling/Disposal Unit with Storage (JLFRS) comes with Storage Position Left (L) or Right (R) and is determined by location of the hinges
- No Identification (N) or Symbol Ready (S) can be specified on recycling/waste section only

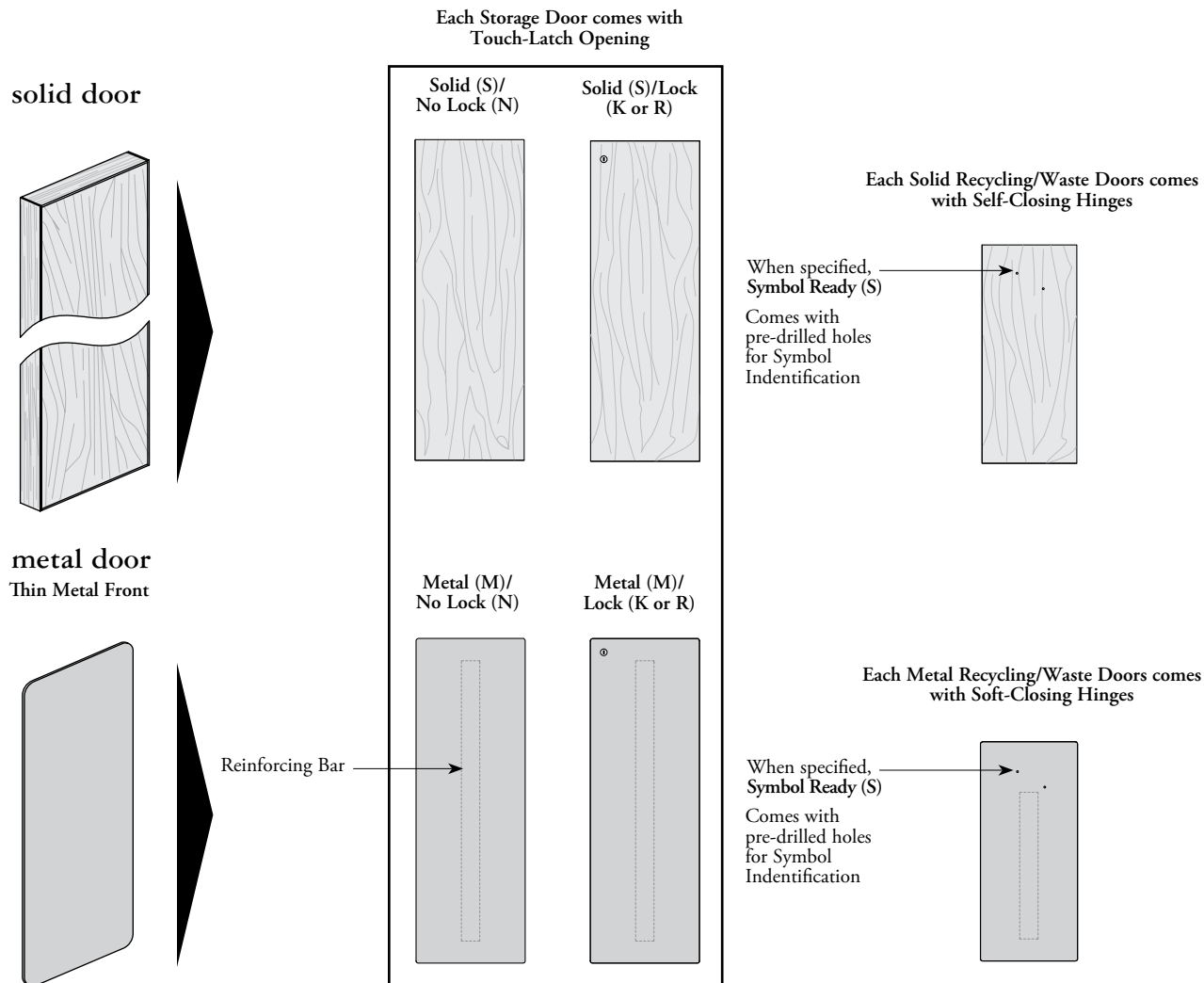

**Lock Styles available:**

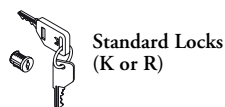

**Symbol Identifications available:**

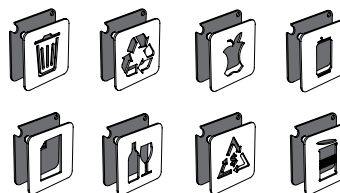

**Recycling/Disposal Unit Symbol (JLASR)**

Not included with Units and must be specified separately. Refer on page 719 for more details

# recycling/disposal unit basics

The Recycling/Disposal Units provide centralized enclosed space for Recycling/Waste Bins for the workstations.

- Metal (M) or Solid Front Style (S) can be specified
- Waste/Recycling Bins are included for each Waste/Recycling section
- Each Waste/Recycling Bin has a capacity of 38 Liter
- A Fixed Angled Metal Opening Fascia is included and protect the surroundings of the openings
- If applicable, can be linked to each other or to Lockers
- Each waste compartment can be identified by a Recycling/Disposal Unit Symbol (JLASR), sold separately. The door front comes with pre-drill holes, when Symbol Ready (S) is specified

## Recycling/Disposal Unit Symbols

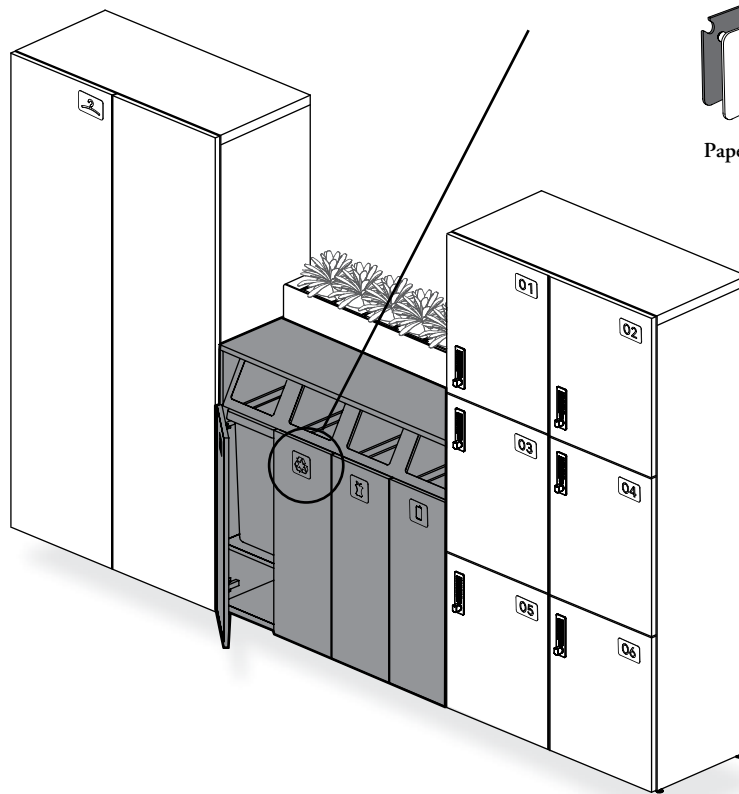
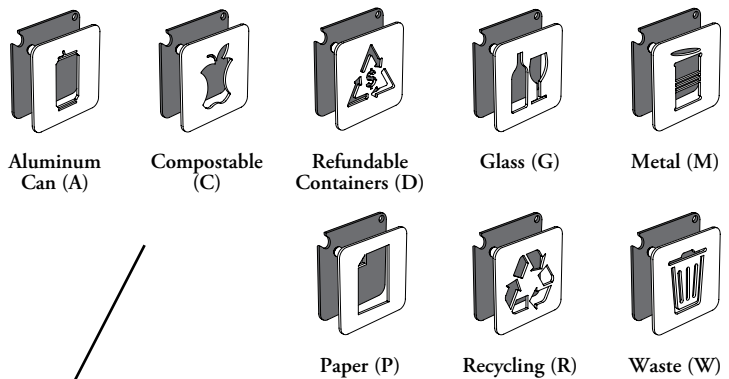

## Finishes

Case Finish: Source Laminate

Metal Front Door Finishes: Foundation, Mica and Accent

Solid Front Door\* Finish: Source Laminate

\* Front, Doors are 11/16" thick

Edge Trim Finishes: Edge Trim Colors (Laminate Front only)

Opening Fascia Finishes: Foundation, Mica or Accent

Fixed or Adjustable Shelves\*\* Finish: Source Laminate and Foundation Laminate

\*\* Shelves are 11/16" thick

## recycling/disposal unit basics (continued)

### Recycling/Disposal Unit (JLFRU) or Elevated Recycling/Disposal Unit (JLERU)

- Provides enclosed storage space for Recycling/Waste Bins
- All Units include a Recycling/Waste Bin in each section
- Available in height of 42" only
- Available in depth of 18" or 24", both depths share the same Recycling/Waste Bins, 24" deep units are only needed to match 24" deep lockers layout
- Each door section is 12" wide and the Recycling/Disposal Unit is offered in dual (D), triple (T) and quadruple (Q) configurations
- A fixed shelf on each section is also available with standard style only
- These units are **not** lockable
- Can be linked with other lockers of the same style and depth

### standard style

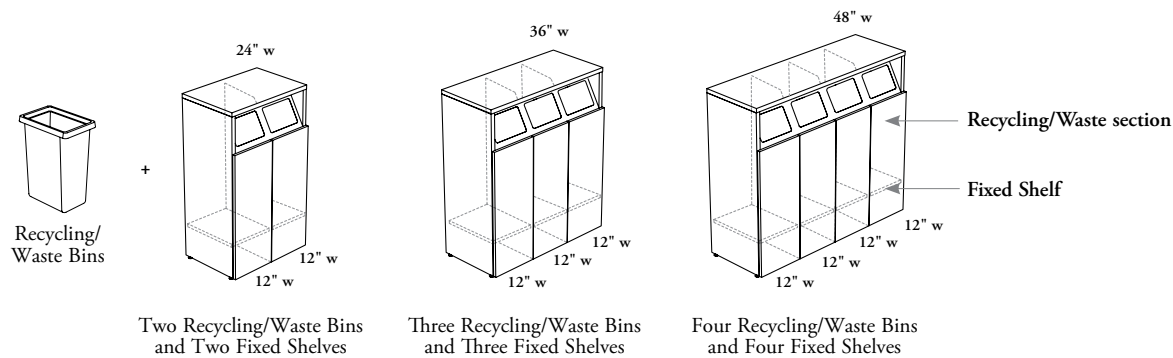

### elevated style

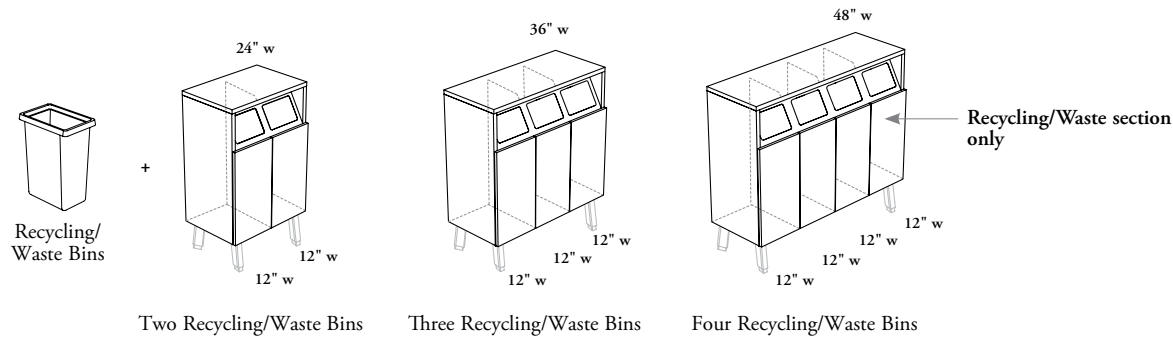

# recycling/disposal unit basics (continued)

## Recycling/Disposal Unit with Storage (JLFRS)

- Provides enclosed storage space for Recycling/Waste Bins and Storage section at the end of the unit
- Have a total height of 42" depth of 18" and widths of 36" – 66" (6" increments)
- Each door of the waste section is 12" wide and the storage door can be 12" or 15" depending on the width configuration
- Unit includes a Recycling/Waste Bin and fixed shelf on each waste section and two adjustable shelves in the storage section
- Storage section comes with two adjustable shelves in 1 1/4" increments
- Three Storage Positions are available and determined from the user side:
  - Both Sides (B)
  - Left (L)
  - Right (R)
- Only the storage section can be lockable. Keyed Alike (K), Keyed Randomly (R) or No Lock (N) option can be specified
- **Cannot** be linked with lockers

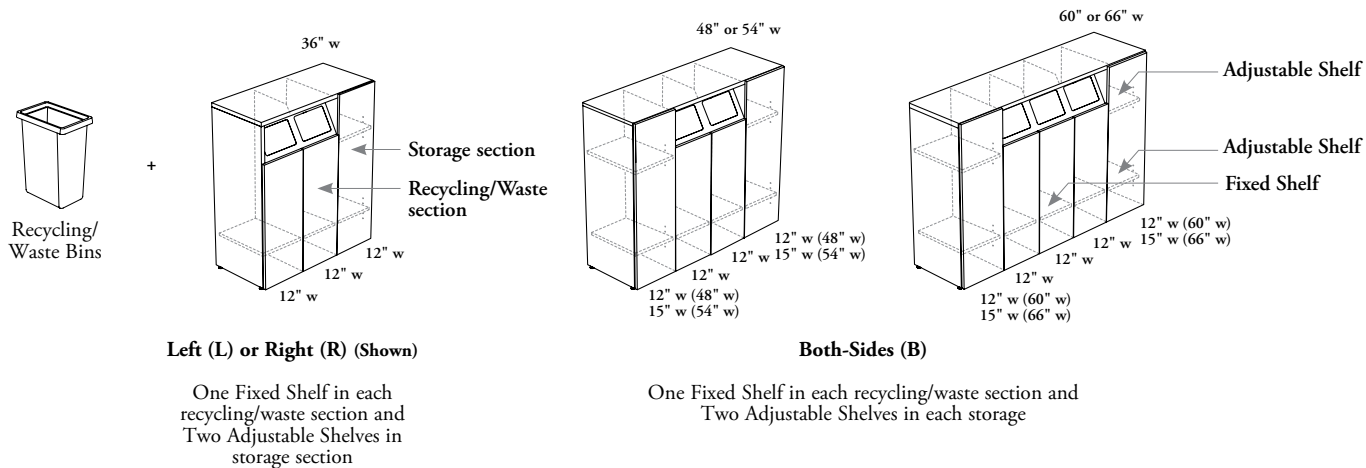

# planning with recycling/disposal units

The following outlines the door and opening heights for all Recycling/Disposal Units.

## door openings

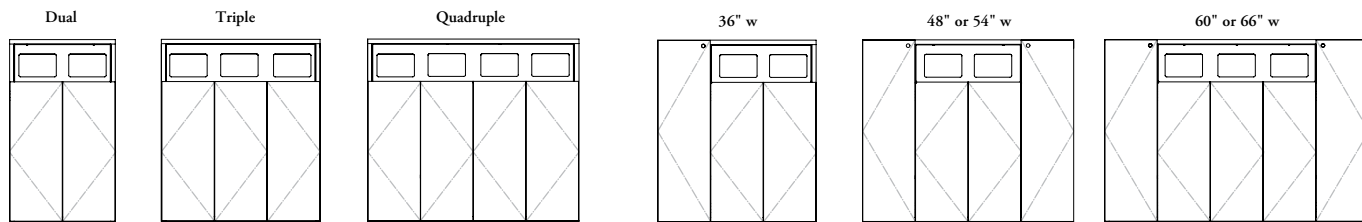

Recycling/Disposal Unit (JLFRU) or Elevated Recycling/Disposal Unit (JLERU)

- Triple Configuration (T) **cannot** be specified left or right

Recycling/Disposal Unit with Storage (JLFRS)

- Left (L) (Shown) or Right (R) Storage Position must be specified for 36" wide unit
- Both Sides (B) Storage Position must be specified for 48" to 66" wide unit

## units doors and overall opening heights

recycling/disposal unit (JLFRU)

Interior compartment dimensions

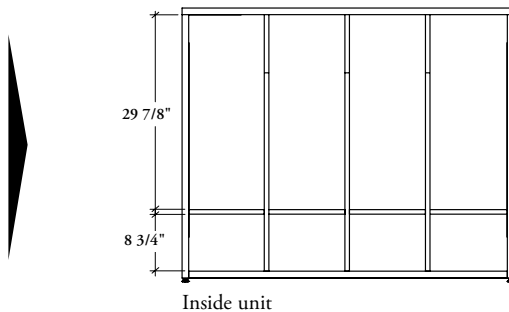

recycling/disposal unit with storage (JLFRS)

Interior compartment dimensions

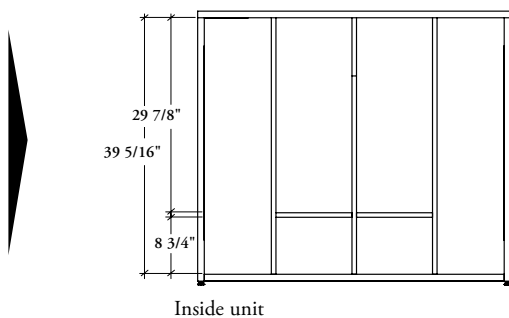



# planning with recycling/disposal units (continued)

units doors and overall opening heights (continued)

elevated recycling/disposal unit (JLERU)

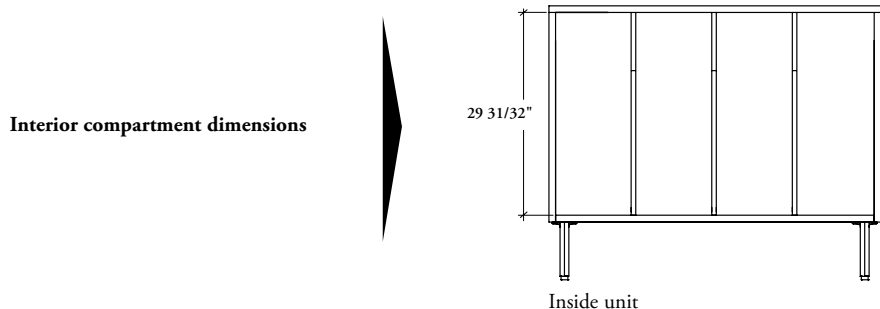

interior configurations

Recycling/Disposal Unit (JLFRU)

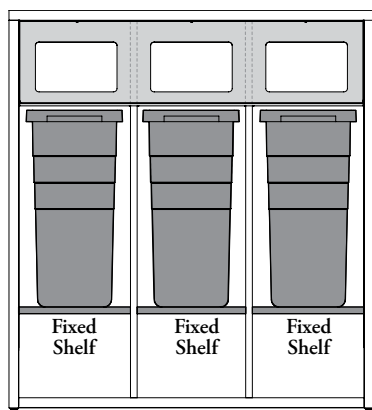

**Shelf & Recycling/Waste Bin**

- One Fixed Shelf and one Recycling/Waste Bin in each section
- Shelves are positioned 8 3/4" from the bottom

Recycling/Disposal Unit with Storage (JLFRS)

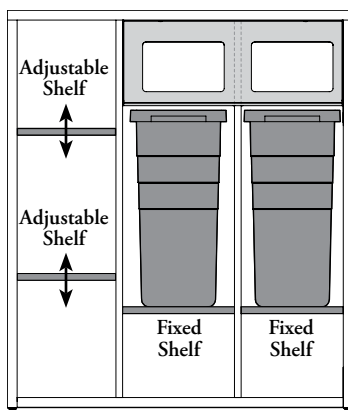

**Shelves & Recycling/Waste Bin**

- **Storage section:** Two Adjustable Shelves
- **Recycling/Waste section:** One Fixed Shelf and one Recycling/Waste Bin
- Storage section comes with holes at 1 1/4" intervals on the inside walls of side panels to allow for shelf adjustment
- Fixed Shelf is positioned 8 3/4" from the bottom

Elevated Recycling/Disposal Unit (JLERU)

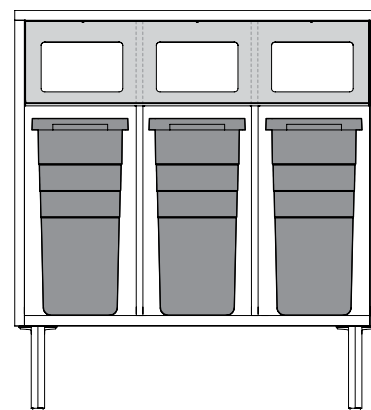

**Recycling/Waste Bin**

One Recycling/Waste Bin in each section

# planning with recycling/disposal units (continued)

The following should be considered when planning with Expansion Cityline Recycling/Disposal Units.

Other special considerations must be taken when 18" deep Elevated Recycling/Disposal Units are specified. For more details, refer to page 698

Recycling/Disposal Units with Levelers can be used freestanding, they **do not** require any attachment to a structure or wall

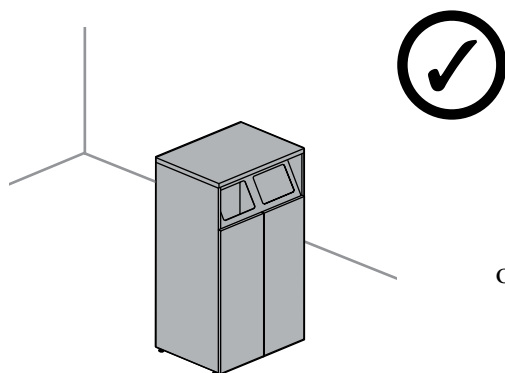

OR

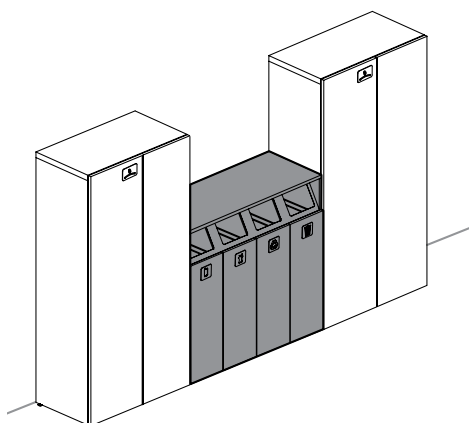
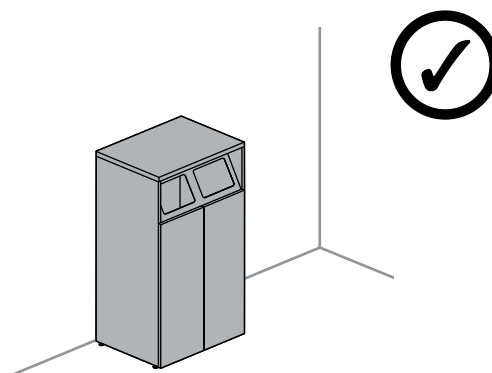

Can be used between two lockers of different datum and linked together

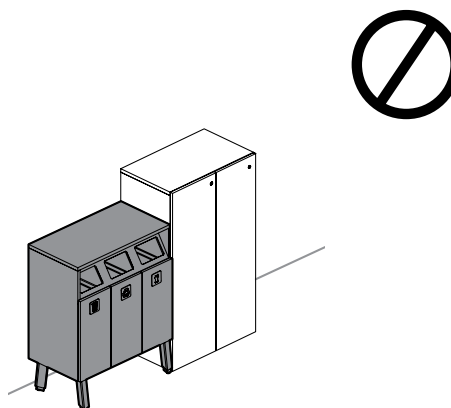

Elevated Recycling/Disposal Unit **cannot** be linked with Lockers on levelers

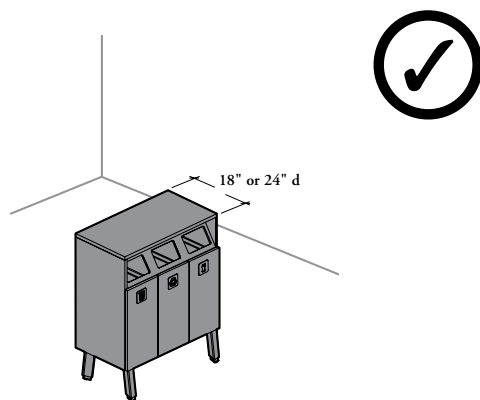

Elevated unit can be used alone without restrictions

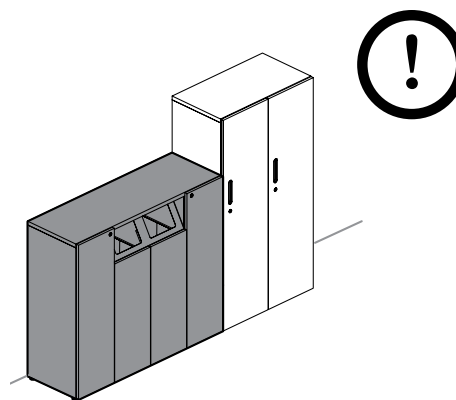

Recycling/Disposal Unit with Storage **cannot** be linked with other Lockers

# planning with recycling/disposal units (continued)

Recycling/Disposal Unit with Storage can be used on- or off-module. Following are examples of on-module applications:

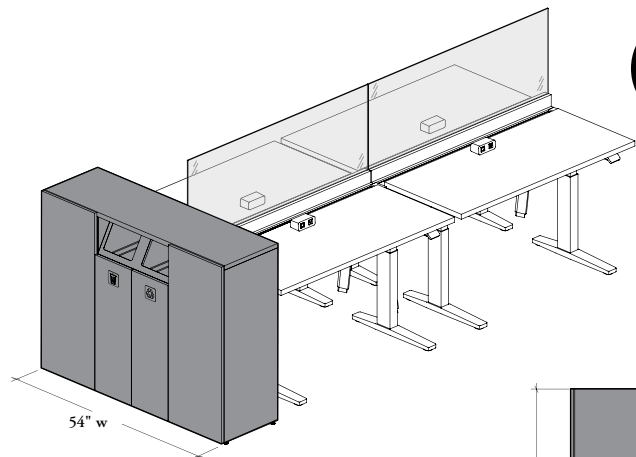

### On-Module Application

When used in a workstation with 23" deep Height-Adjustable Table parallel to the beam, the 54" wide Recycling/Disposal Unit will be equal to the width of the workstation

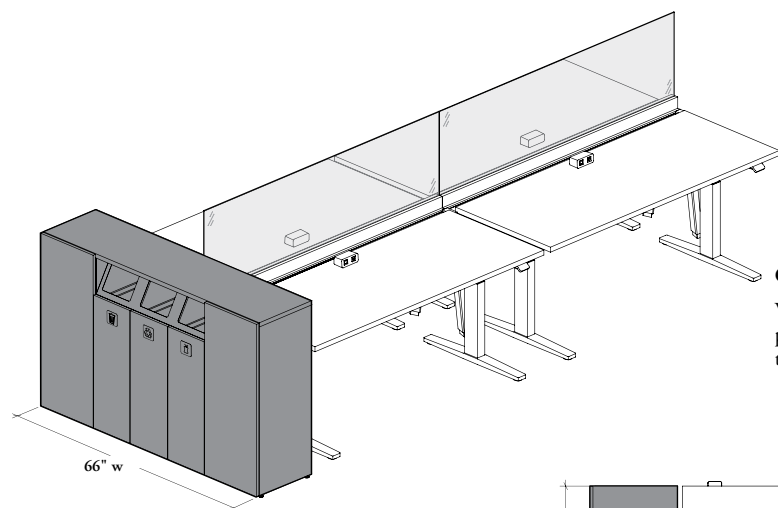
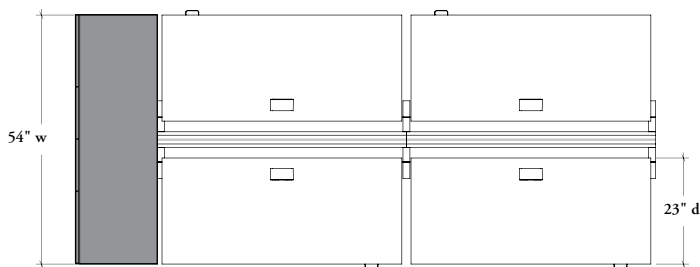

### On-Module Application (continued)

When used in a workstation with 29" deep Height-Adjustable Table parallel to the beam, the 66" wide Recycling/Disposal Unit will be equal to the width of the workstation

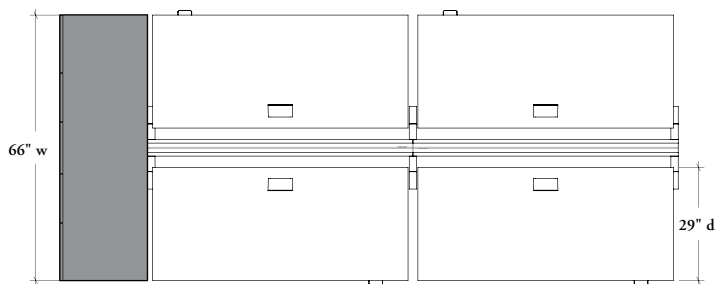

## angled foot sharing applications – elevated lockers & recycling/disposal units

The following should be considered when planning Elevated Lockers, Common Elevated Lockers, Open Elevated Lockers or Recycling/Disposal Units with Angled Foot.

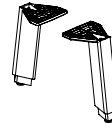

### Angled Foot Kit for Elevated Locker (JLEFK)

- Come in pair
- Height: 10"
- Storage Depths: 18" or 24"
- Leveling range of 3" (-3/16", +2 13/16")

### elevated lockers

- Lockers must be supported at each ends by an Angled Foot Kit (JLEFK). One kit is required at the junction of two units
- Lockers provide many foot positions to allow symmetrical and more equal distribution of foot at installation. Refer on page 709 for a better foot distribution
- End position is used at the end of a locker layout. In-line and shifted position are used at the junction of units (reconfigurable left side or right side)

#### Dual Lockers (Shown) or Common Lockers

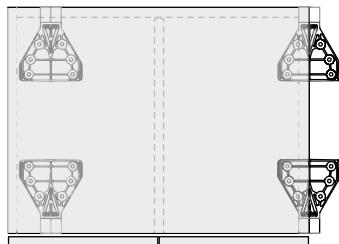

End

In-Line

#### Triple Lockers

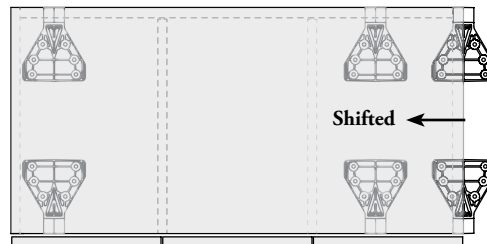

End

In-Line

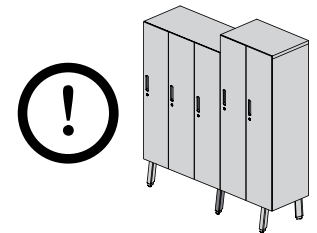

In-Line



It is aesthetically recommended to use the In-Line position when connecting lockers of different heights

### recycling/disposal units

Units have many foot positions to allow symmetrical and more equal distribution of foot between layout. Only end and in-line positions are available for Recycling/Disposal Units

#### Dual Units

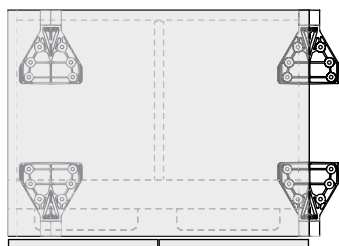

End

In-Line

#### Triple Units

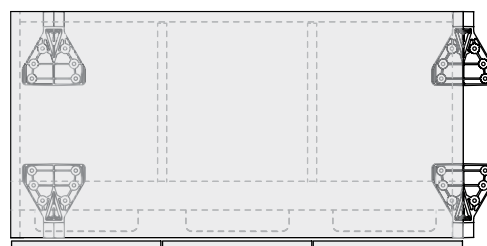

End

In-Line

#### Quadruple Units

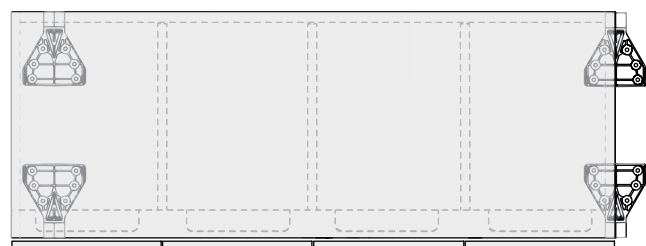

End

In-Line

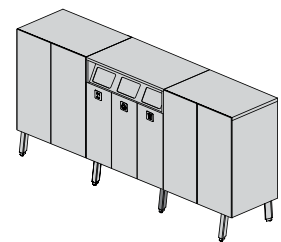

In-Line

In-Line



# angled foot sharing applications – elevated lockers & recycling/disposal units (continued)

- It is recommended to use the minimum amount of locker units (favor triple ③ over dual ② configurations) to create the required layout
- Distribute lockers in a symmetrical layout (example: 2-3-2 and not 2-2-3)
- When mixing dual and triple lockers, dual lockers should be placed in the center for a better foot distribution (example: 10 sections side-to-side = 3-2-2-3 and not 2-3-3-2)

## angled foot sharing positions – dual & triple elevated lockers (recommendations for optimal aesthetic and cost efficiency)

Lockers for 2 sections – End / End

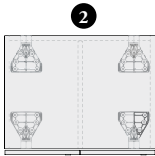

Lockers for 3 sections – End / End

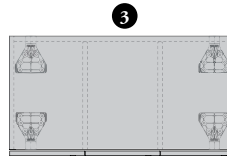

Lockers for 4 sections – End / In-Line / End

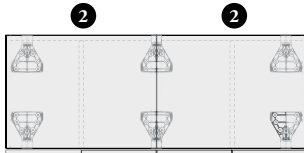

Lockers for 5 sections – End / Shifted / End

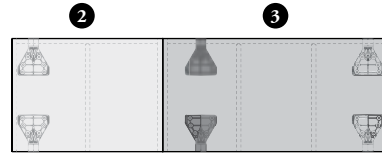

Lockers for 6 sections – End / In-Line / End

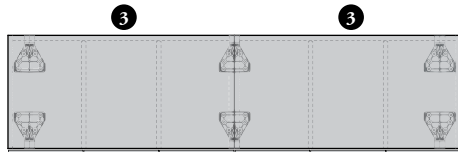

Lockers for 7 sections – End / In-Line / In-Line / End

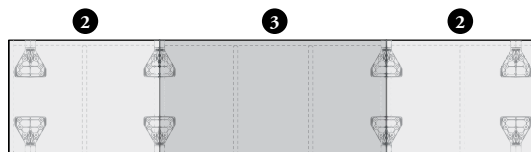

Lockers for 8 sections – End / Shifted / Shifted / End

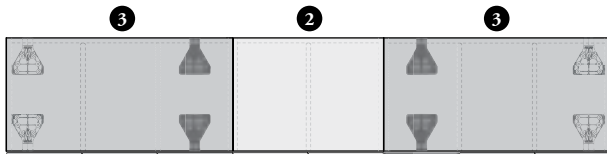

Lockers for 9 sections – End / In-Line / In-Line / End

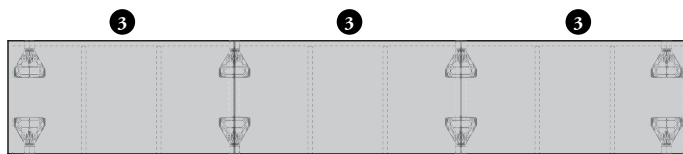

Lockers for 10 sections – End / Shifted / In-Line / Shifted / End

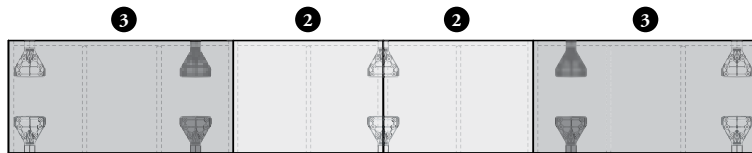

Shifted Foot

# angled foot sharing applications – elevated lockers & recycling/disposal units (continued)

## angled foot sharing positions – dual & triple elevated lockers (continued)

Lockers for 11 sections – End / In-Line / Shifted / In-Line / End

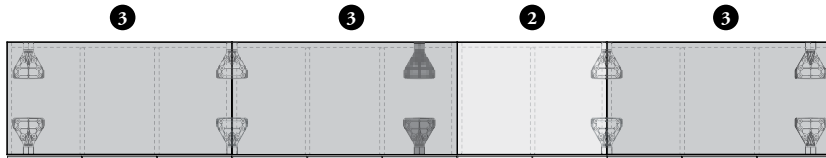

Lockers for 12 sections – End / In-Line / In-Line / In-Line / End

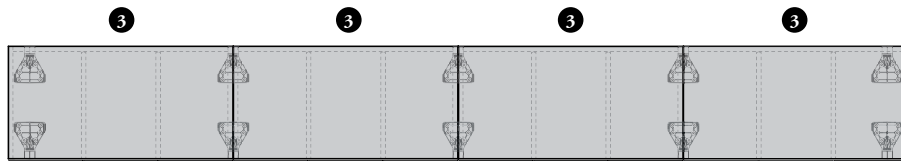

Lockers for 13 sections – End / Shifted / In-Line / In-Line / Shifted / End

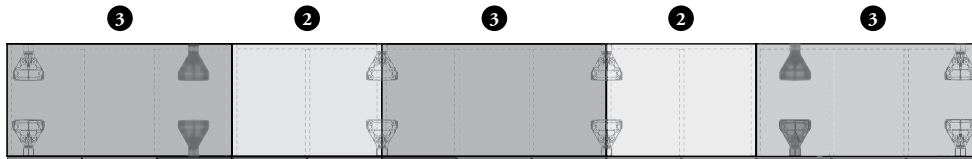

Lockers for 14 sections – End / In-Line / Shifted / Shifted / In-Line / End

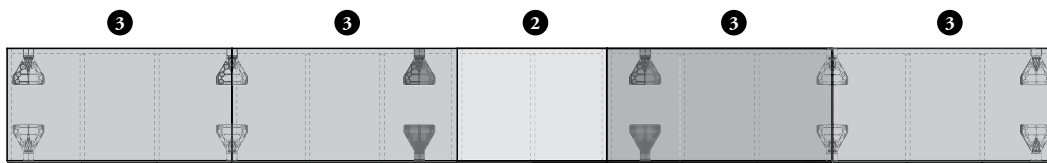

Lockers for 15 sections – End / In-Line / In-Line / In-Line / In-Line / End

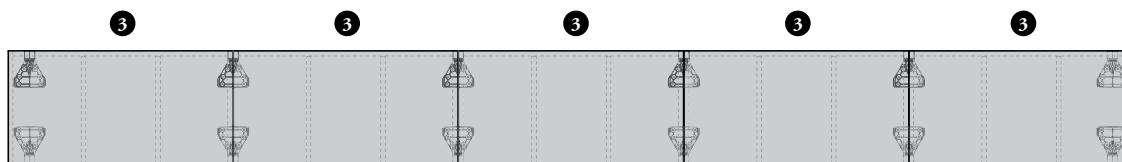

Shifted Foot



## digital lock details

Lockers accept a locking technology, offering a digital numeric keypad lock as standard. Specific client security needs can be fulfilled from an extensive range of products supported by Teknion suppliers.

### versa mini 6th generation

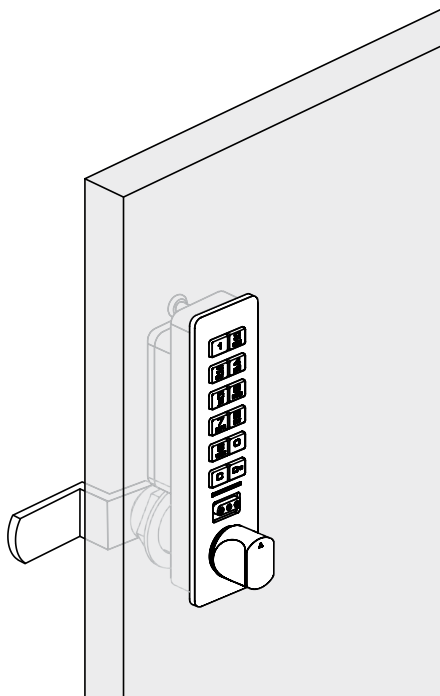

#### Product Details

- Alpha Numeric Keypad Operation
- User Code may contain from 4 to 7 digits
- Each lock may be assigned up to 20 user codes and/or user keys
- Available recess mount for a flush look
- Vertical orientation with pull on bottom (pull also act as lock)
- Finished in Brushed Nickel
- **Cannot** be used with glass door
- The Digital Keys (JLKEE) are required and must be specified separately



- Access to battery is enable from the interior of the locker
- Two AAA Disposal Batteries are included, rechargeable batteries can also be used. It is **not** necessary to unistall the lock for batteries replacement

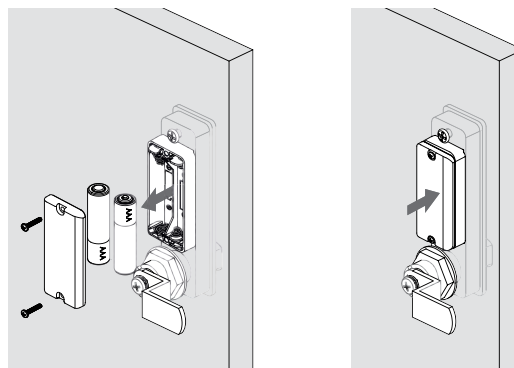



# digital lock key basics

The Digital Lock specified on the Lockers or Suspended Personal Storage – Door (JNAUE) are provided by Digilock. NOTE that no Programming, Manager and/or User Key will be sent with the Lockers when specified with the Digital Lock option.

- Cityline 6th Generation Digital Keys (JLKEE) are the only keys compatible with Cityline products. They are also compatible work 5th Generation Versa Mini Lock in other product lines
- For the **Digilock** products, keys are ordered separately since there is no requirement for every digital lock to have its own individual key
- Manager (M) and Programming (P) keys include four AA batteries that can be changed easily
- Three key types are available:

## Programming Key (P)

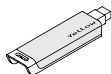

- Each lock can be paired with one programming key
- Required for initial programming of the lock and Manager Keys
- One programming key per site is recommended
- It has the capability to override access, operate and set the functionality of the lock
- Provides external power when battery is dead
- Can be used for lock maintenance (batteries change) or management inspection
- Each Programming Key is programmed by **Digilock**, therefore they will require the related **Teknion** order number to program the key to the existing locks. Contact the **Teknion** Customer Service team. This will allow **Digilock** to program the new keys for the locks that are on order or already on site.

## Manager Key (M)



- Required for programming and managing of user codes
- Up to six Manager Keys can be programmed to each lock
- Overrides user access
- Provides external power
- Can be used for lock maintenance (batteries change) or management inspection
- The Manager Key is programmed by the Programming Key and **not** directly by **Digilock**. Therefore, additional Manager Keys can be ordered after initial set up.

## User Key (U)



- Optional key that allows access to the storage product without using or bypassing the keypad, ideal for ADA solution
- This key can be ordered later without being programmed to the existing locks with the assistance of a Manager Key

**NOTE:** the **Digilock** is **not** manufactured by **Teknion** and therefore it is **not** covered by the **Teknion** Warranty. **Digilock** offers a two year warranty for the digital lock products.

For all further inquiries related to the Programming, Manager and User Key products, refer to **Digilock** directly for assistance. The **Digilock** can also provide the related documents. Contact **Digilock** sales support, support@digilock.com or call 707-766-6000.

# pull, standard lock & digital lock positions – lockers & recycling/disposal units

- The pull & lock positions may vary depending on locker size chosen
- These positions are the same for the Standard and Elevated Lockers only
- Left (L) or Right (R) Door Swing Orientation can be specified, the Right Door Swing is shown below



## standard lock positions for lockers

- Available with Metal (M) or Solid (S) Front Style. Also available with Lockers – Full Glass Doors (JLFFG and JLEFG)
- **Not** available with Common Lockers (JLFSD, JLFSG, JLESD or JLESG)

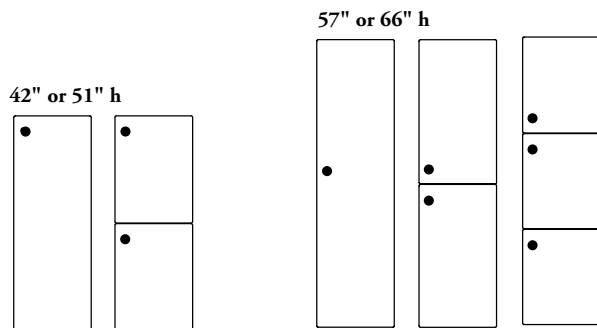

## pull with standard lock positions for lockers

- Available with Metal with Pull (N) or Solid with Pull (T) Front Style only
- **Not** available with Lockers with Glass Doors (JLFSG, JLFFG, JLEFG or JLESG)
- \* Common Lockers (JLFSD or JLESD) come with pull only, **no lock included**

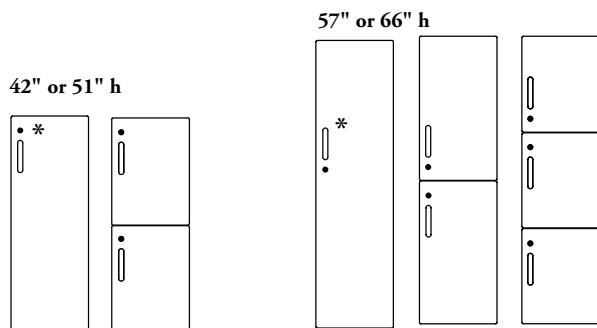

## digital lock positions for lockers

- Available with Metal with Digital Lock (O) or Solid with Digital Lock (U) Front Style only
- **Not** available with:
  - All Common Lockers (JLFSD, JLFSG, JLESD or JLESG)
  - Lockers with Glass Doors (JLFFG or JLEFG)

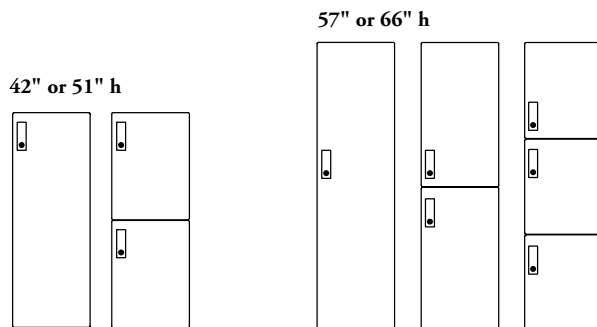

# pull, standard lock & digital lock positions – lockers & recycling disposal units (continued)

- Pulls & Digital Locks are **not** available with Recycling/Disposal Units
- These positions are the same for the Standard or Elevated Style

## standard lock positions for recycling/disposal units

- Available with Metal (M) or Solid (S) Front Style only
- Available with Recycling/Disposal Unit with Storage (JLFRS) only
- Only storage section can be lockable

36" w

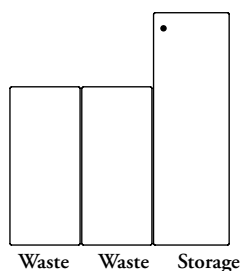

48" to 66" w

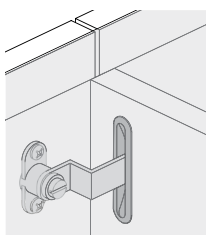
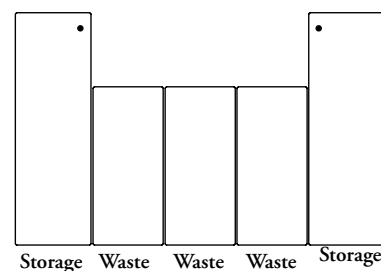

### Locking Cup

- When Lockers and Recycling/Disposal Unit with Storage (JLFRS) are specified with standard or digital locks, the cam is inserted into a locking cup that sits flush with the storage side. This locking characteristic offer clean aesthetic and prevent damage of personal items
- Finished in Soft Gris coordinate

# lock chart – lockers & recycling/disposal units

- If specified, all closed storage products come with a lock and key set and can be keyed alike or randomly. A Key Chart must accompany every order, otherwise orders will be shipped keyed randomly
- Available with Metal (M), Solid (S) or Glass Front Style only

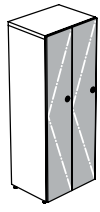
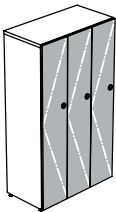
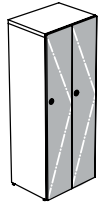
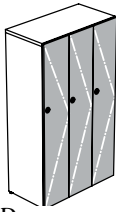
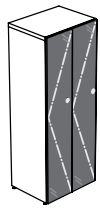
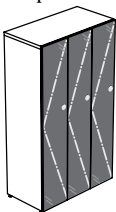
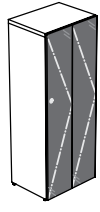
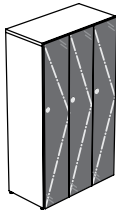
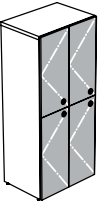
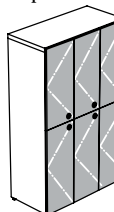
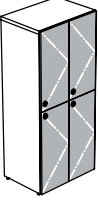
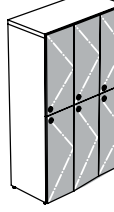
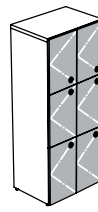
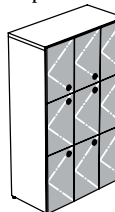
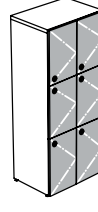
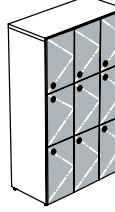
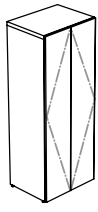
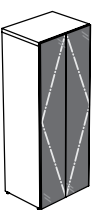
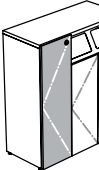
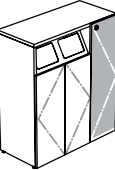
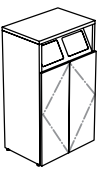
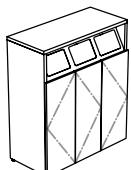
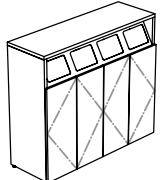
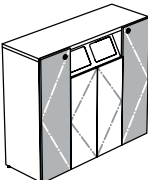
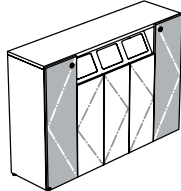
	number of locks		number of locks		number of locks
<p>Door Swing – Left</p> <p>Dual</p>  <p>Triple</p>  <p>Door Swing – Right</p>   <p>JLFFD</p> <p>Door Swing – Left</p> <p>Dual</p>  <p>Triple</p>  <p>Door Swing – Right</p>   <p>JLFFG</p>		<p>Door Swing – Left</p> <p>Dual</p>  <p>Triple</p>  <p>Door Swing – Right</p>   <p>JLFC2</p>	<p>4 x (dual) or 6 x (triple)</p>	<p>Door Swing – Left</p> <p>Dual</p>  <p>Triple</p>  <p>Door Swing – Right</p>   <p>JLFC3</p>	<p>6 x (dual) or 9 x (triple)</p>
	<p>2 x (dual) or 3 x (triple)</p>	  <p>JLFS or JLFSG</p>	<p>0 x</p>	<p>36" w</p>   <p>JLFRS</p>	<p>1 x</p>
		   <p>JLFRU</p>	<p>0 x</p>	<p>48" or 54" w</p>  <p>60" or 66" w</p>  <p>JLFRS</p>	<p>2 x</p>

Lockable Single Door
  Not Lockable

# lock chart – lockers & recycling/disposal units (continued)

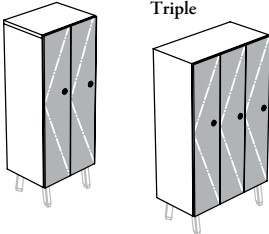
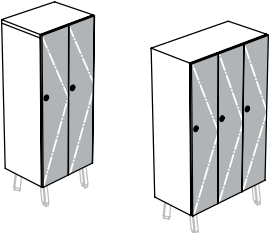
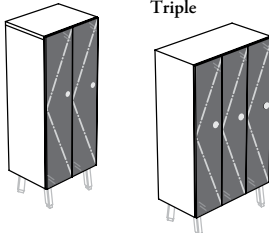
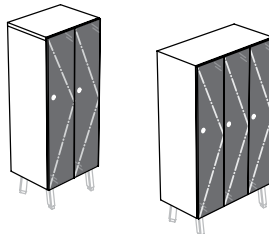
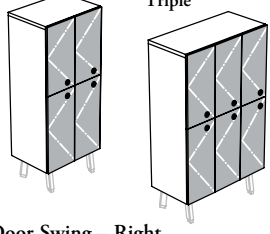
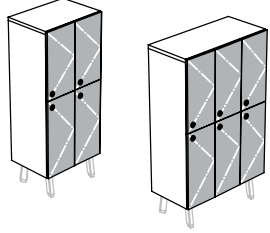
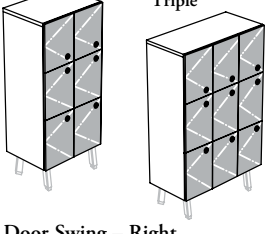
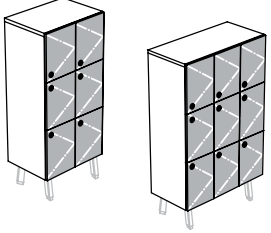
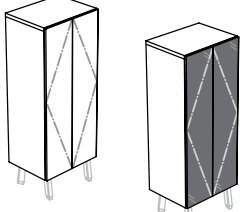
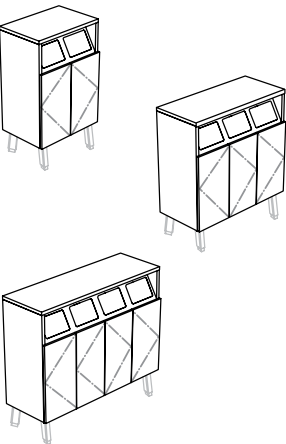
	number of locks		number of locks		number of locks
<p>Door Swing – Left Dual</p>  <p>Triple</p> <p>Door Swing – Right</p>  <p>JLEFD</p> <p>Door Swing – Left Dual</p>  <p>Triple</p> <p>Door Swing – Right</p>  <p>JLEFG</p>		<p>Door Swing – Left Dual</p>  <p>Triple</p> <p>Door Swing – Right</p>  <p>JLEC2</p>	<p>4 x (dual) or 6 x (triple)</p>	<p>Door Swing – Left Dual</p>  <p>Triple</p> <p>Door Swing – Right</p>  <p>JLEC3</p>	<p>6 x (dual) or 9 x (triple)</p>
	<p>2 x (dual) or 3 x (triple)</p>	 <p>JLES D or JLES G</p>	<p>0 x</p>		
		 <p>JLER U</p>	<p>0 x</p>		

 Lockable Single Door

 Not Lockable

## grain direction – lockers & recycling/disposal units

Grain direction is important when planning with storage. The following examples demonstrate this. Laminates do not have one-way grain direction but rather a bi-directional grain pattern.

- Grain/patterns are not "centered" on storage unit
- Includes Source or Foundation Laminate (Standard, Finegrain and Straightgrain)
- Door grain direction will always be vertical
- Door front grain direction will vary depending on product and finish selected
- Available for Standard and Elevated Styles

### dual or triple lockers

#### Cathedral Grain Pattern:

Source Laminate

- 3A – 3B – 3C – 3D – 3E – 3L – 3M – 3X – XQ – XR

Foundation Laminate

- 2A – 2B – 2C – 2D – 2E – 2L – 2M – 2X – RQ – YR

For colors listed above, the Cathedral Grain Pattern for door fronts will be book-matched

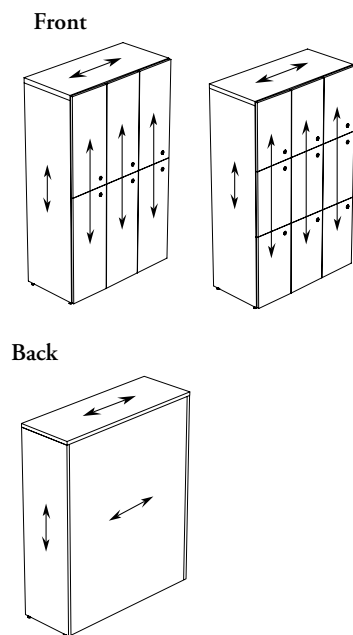

### lockers & recycling/disposal units

#### Straight Grain Pattern:

Source Laminate

- 3F – 3J – 3K – 3N – 3P – XJ – XK

Foundation Laminate

- 2F – 2J – 2K – 2N – 2P – JG – RN

Flintwood

- FC – FD – FM – FN – FX – NR – NT – VA – VB – VZ – 5N – 5P – 5Q – 5R – 5S – 5T – 5V – 5W – 5Z

For colors listed above, the Straight Grain Pattern for door fronts will be vertical

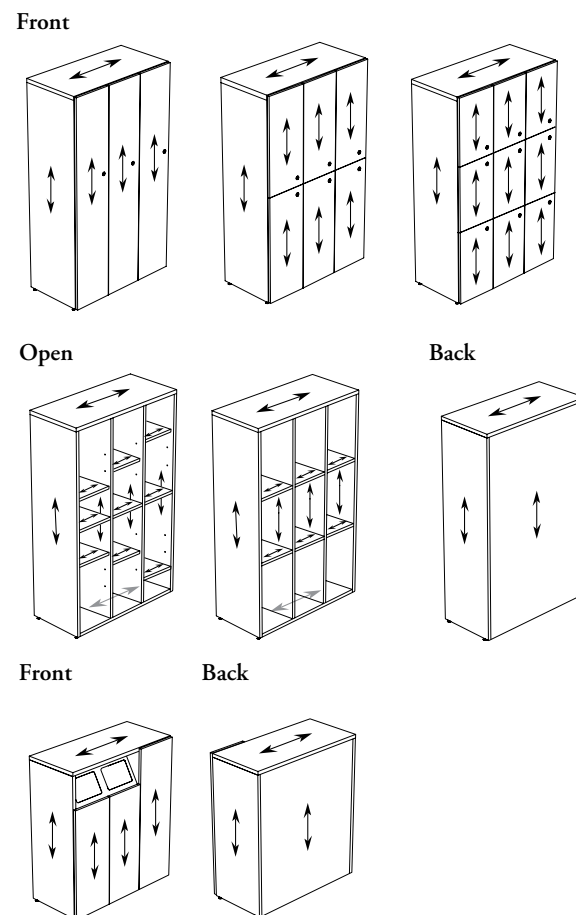

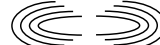
Laminate Grains ←→ = Grain Direction = 

# number & symbol identification basics

## Metal plate identifications for Lockers and Recycling/Disposal Units.

- Each Locker compartment can be identified by a number or Recycling/Disposal Units by a symbol. Common Lockers can also be identified by a Common Locker Symbol
- Solid (S) or metal (M) door fronts come with pre-drill holes when Number Ready (R) is specified on Lockers or when Symbol Ready (S) is specified on Common Locker or Recycling/Disposal Units
- **Cannot** be specified on Glass Door Fronts
- Recycling/Disposal Units Symbols **cannot** be used with Lockers and vice versa

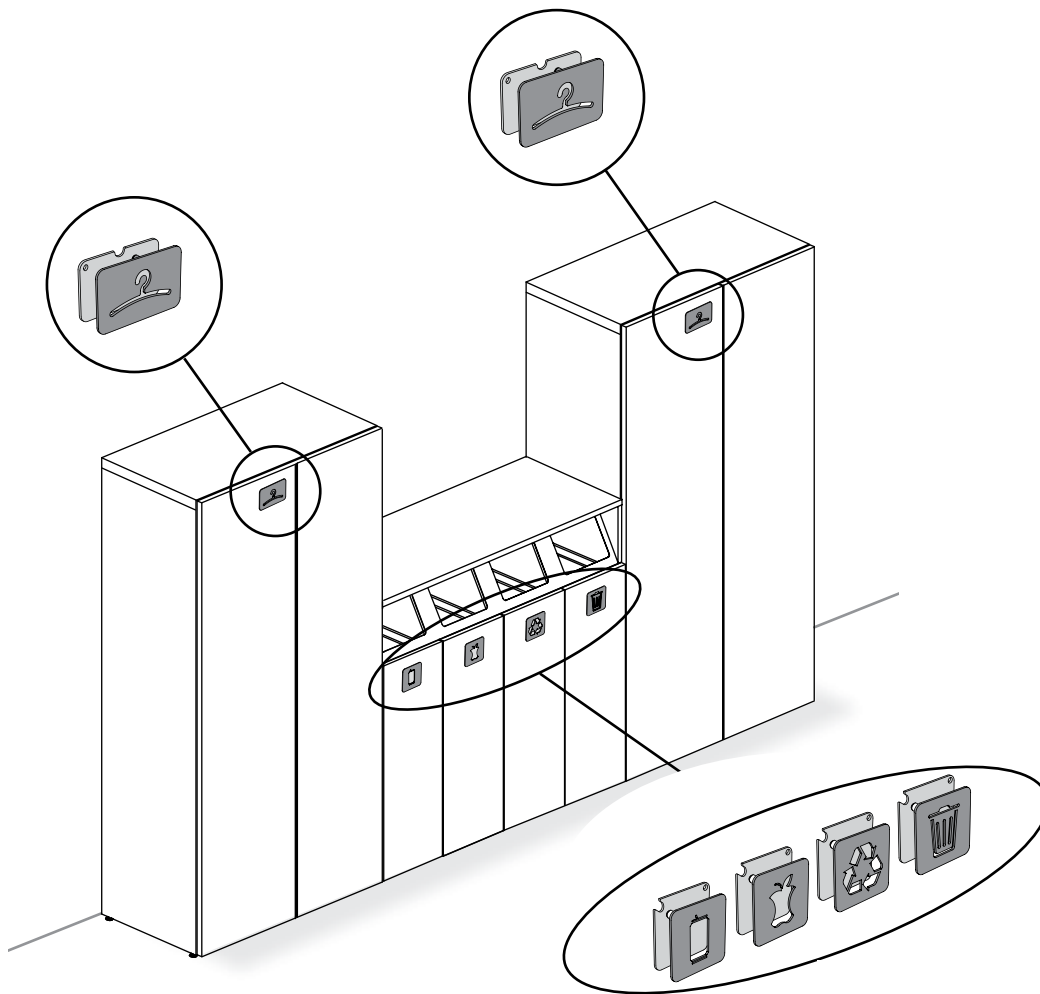

### Finishes

Front Plate Finishes: Foundation, Mica and Accent

Back Plate Finishes (If Applicable): Foundation, Mica and Accent

## reconfigurable

Numbers or Symbols Metal Plate are mechanically installed on door and can easily be reconfigured without tools

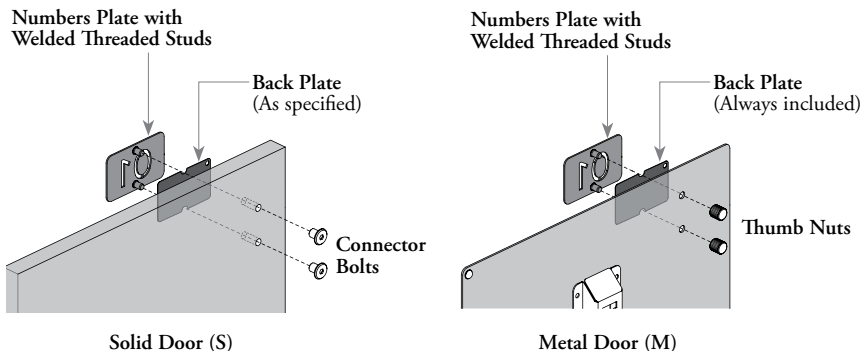

## number & symbol identification basics (continued)



### Locker Number (JLANN)

- Locker Number is always positioned at the top of door on door swing side
- Can be specified with Standard or Elevated Lockers only
- Two configurations are offered:
  - One Plate (O) : 01 to 99
  - Set of 10 Plates (S): 0110 (From 01 to 10) to 8190 (From 81 to 90)
- Can be specified on Metal (M) or Solid (S) Door Styles
- None (N) or With Back Plate configuration (W) can also be specified

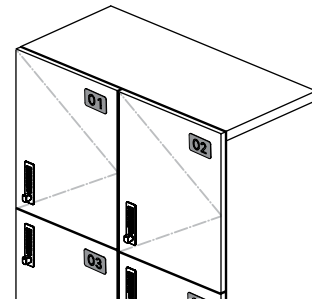

### Common Locker Symbol (JLASS)

- Common Locker Symbol is always positioned at the top right of left door
- Can be specified with Standard or Elevated Common Lockers only
- Comes with Hanger Symbol (H)
- Can be specified on Metal (M) or Solid (S) Door Styles
- None (N) or With Back Plate configuration (W) can also be specified

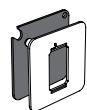
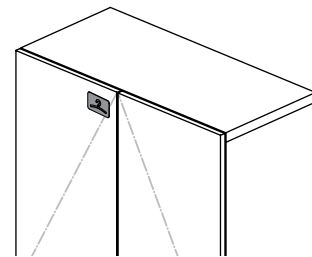

Aluminum  
Can (A)



Compostable  
(C)



Refundable  
Containers (D)



Glass  
(G)



Metal  
(M)



Paper  
(P)



Recycling  
(R)



Waste  
(W)

### Recycling/Disposal Unit Symbol (JLASR)

- Recycling/Disposal Unit Symbols are always positioned at the center top of door
- Can be specified with Standard or Elevated Recycling/Disposal Units only
- Can be specified on Metal (M) or Solid (S) Door Styles
- None (N) or With Back Plate configuration (W) can also be specified

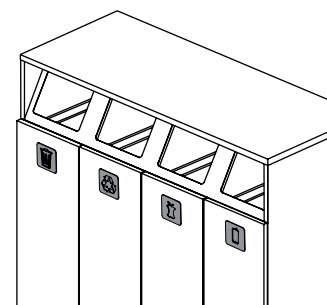



# planning with number & symbol identifications

## front & back plate applications

Many ways to specify the Locker Numbering, Common Locker and Recycling/Disposal Unit identification

Metal Door

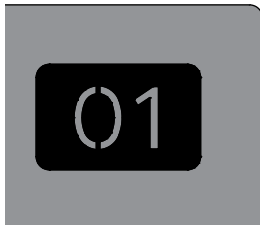

Solid Door



### Highlighted Plate

- The plate can be highlighted on the door to create a stronger visual statement, using or not a back plate to create an accent on the number
- To create a see-through look with metal, the back plate must be specified with the same color than the door
- With solid doors, numbers can be specified without back plate to create a true see-through look

Metal Door



### Highlighted Numbers

To create a highlighted numbers the front plate can be specified with the same or similar color than the door, and the back plate can be specified to the desired highlight color

Metal Door



### Subtle Numbers

To create more subtle numbers, the front and the back plates can be specified with the same or similar color than the door

## numbered plate positions

Numbers can be installed following different patterns, that choice is made at the installation

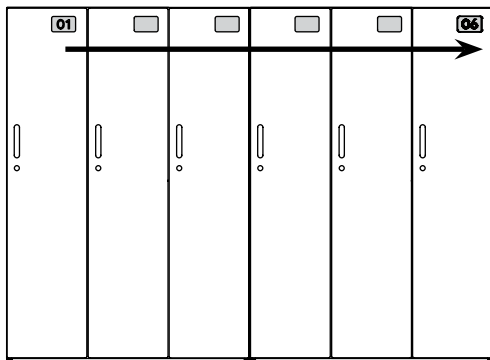

Linear

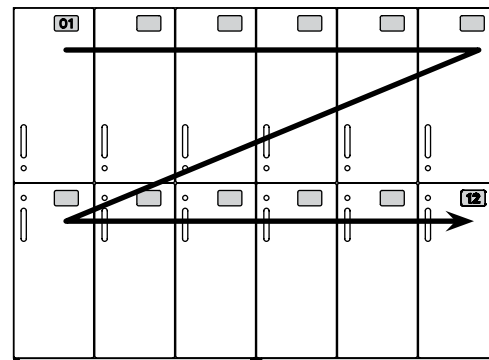

Linear – from Top to Bottom

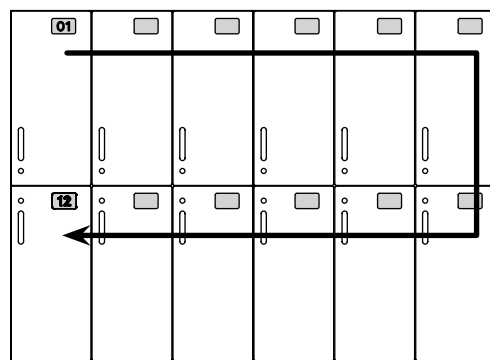

Circular – from Top to Bottom

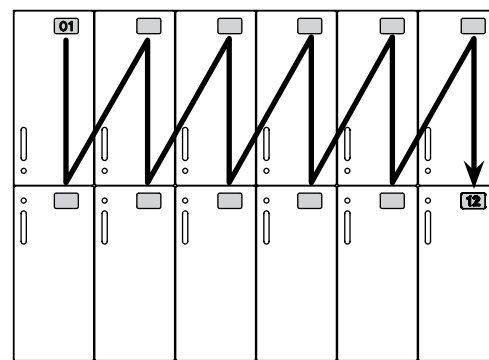

Alternately – Top to Bottom