

# workwall storage

UNDERSTANDING WORKWALL KNEESPACE MODULES . . . . .	340
WORKWALL KNEESPACE MODULE COMPONENTS . . . . .	343
WORKWALL KNEESPACE MODULE BASICS . . . . .	346
WORKWALL KNEESPACE MODULE REMOVABLE FRONT PANEL WIDTHS . . . . .	349
UNDERSTANDING WORKWALL BOOKCASES – MID – 21" H. . . . .	354
WORKWALL BOOKCASE – MID – 21" H – COMPONENTS . . . . .	356
WORKWALL BOOKCASE – MID – 21" H – BASICS . . . . .	357
WORKWALL BOOKCASE – MID – 21" H – OPEN COMPARTMENT WIDTHS . . . . .	359
WORKWALL BOOKCASE – MID – 21" H – INTERIOR CLEARANCE . . . . .	360
PLANNING WITH WORKWALL KNEESPACE MODULES & WORKWALL BOOKCASES – MID – 21" H. . . . .	361
WORKWALL STORAGE – INTEGRAL TOP – 29" H – BASICS . . . . .	363
WORKWALL CABINET & STRETCH PEDESTAL – MID – 21" H – BASICS . . . . .	365



# workwall storage (continued)

WORKWALL CABINET – MID – 21" H – INTERIOR CLEARANCE . . . . .	366
UNDERSTANDING WORKWALL CREDENZAS – MID – 21" H. . . . .	367
WORKWALL CREDENZA – MID – 21" H – COMPONENTS. . . . .	370
WORKWALL CREDENZA – MID – 21" H – BASICS . . . . .	372
WORKWALL CREDENZAS FOR FIXED OR HEIGHT-ADJUSTABLE WORKSURFACES – DRAWER WIDTHS . . . . .	375
WORKWALL CREDENZA – MID – 21" H – INTERIOR CLEARANCE. . . . .	386
WORKWALL CREDENZAS – MID – 21" H FOR FIXED OR HEIGHT- ADJUSTABLE WORKSURFACES – FILING DRAWER CAPACITIES . . . . .	387
PLANNING WORKWALL CREDENZAS – MID – 21" H FOR FIXED OR HEIGHT-ADJUSTABLE WORKSURFACES . . . . .	388
WORKWALL STORAGE – PRODUCT OFFERING . . . . .	389
WORKWALL STORAGE – LOCK CHART. . . . .	392
WORKWALL STORAGE – CONNECTING DEVICES . . . . .	395
WORKWALL STORAGE FINISHES . . . . .	396
WORKWALL STORAGE – GRAIN DIRECTION . . . . .	398

## understanding workwall kneespace modules

All dimensions in this section are nominal

### workwall kneespace modules

- Two styles can be specified:
  - **Standard:**  
Fixed or Height-Adjustable Worksurfaces (BHKHW, BHKHF or BHKFW)
  - **Full-Modesty:**  
Fixed or Height-Adjustable Worksurfaces (BHKHM, BHKHL or BHKFR)
- Can support Wall Panels (B\_WCC, B\_WCO, B\_WAA, B\_WOO, B\_WMD, B\_WMO or B\_WMM)
- For more details on Workwall Kneespace Module Applications, refer to page [361](#)

### standard style

#### Workwall Kneespace Module – Height-Adjustability (BHKHW)

Only products illustrated below can be installed on this module:

For more details on these products listed below, refer to Multi-Level Workstations Section

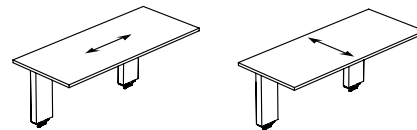

Height-Adjustable Rectangular Worksurfaces  
(BH\_RL or BH\_RC)

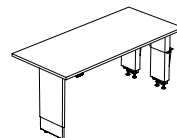

Height-Adjustable  
Rectangular Peninsula  
(BH\_RP)

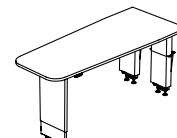

Height-Adjustable  
Tapered Peninsula  
(BH\_TP)

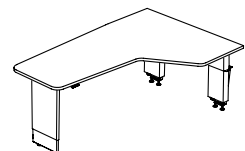

Height-Adjustable Extended  
Tapered Peninsula  
(BH\_PE)

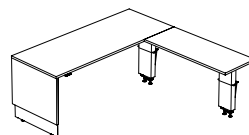
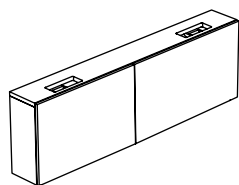

Height-Adjustable  
L-Shape Run-Off  
(BH\_LB)

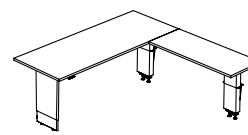

Height-Adjustable  
L-Shape Peninsula  
(BH\_L)

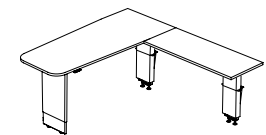

Height-Adjustable L-Shape  
Tapered Peninsula  
(BH\_LT)

For more details on these products listed below, refer to Meeting Tables Section

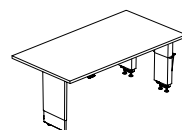

Height-Adjustable  
Rectangular Meeting  
Peninsula  
(B\_HRW)

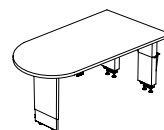

Height-Adjustable  
D-Shape Meeting  
Peninsula  
(B\_HDW)

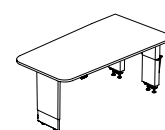

Height-Adjustable  
Tapered Meeting  
Peninsula  
(B\_HBW)



Height-Adjustable  
Diamond Meeting  
Peninsula  
(B\_HPW)

# understanding workwall kneespace modules (continued)

## standard style (continued)

### Workwall Kneespace Module – Height-Adjustability and Fixed Worksurface (BHKHF)

Only products illustrated can be installed on this module:

For more details on these products listed below, refer to Multi-Level Workstations Section

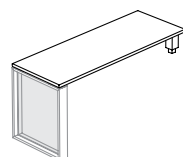
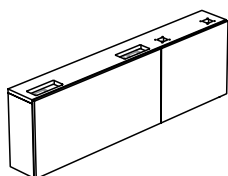

Fixed Run-Off – Mid-Height  
(BM\_R)

For more details on this product, refer to page 92 and following pages

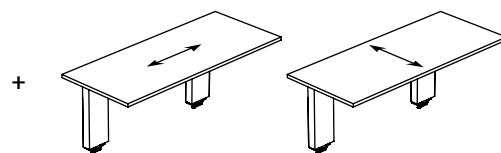

Height-Adjustable Rectangular Worksurfaces  
(BH\_RL or BH\_RC)

+

For more details on these products listed below, refer to Meeting Tables Section

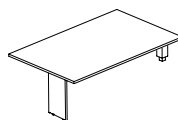

Fixed Rectangular Meeting Peninsula  
(BC\_FR)

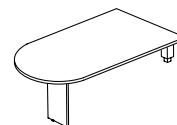

Fixed D-Shape Meeting Peninsula  
(BC\_FD)

### Workwall Kneespace Module – Fixed Worksurface (BHKFW)

Only products illustrated can be installed on this module:

For more details on these products listed below, refer to Multi-Level Workstations Section

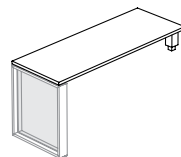
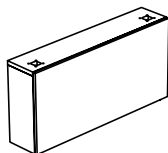

Fixed Run-Off – Mid-Height  
(BM\_R)

For more details on this product, refer to page 92 and following pages

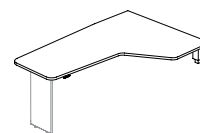

Fixed Extended Tapered – Mid-Height  
(BM\_EP)

For more details on this product, refer to page 93 and following pages

For more details on these products listed below, refer to Meeting Tables Section

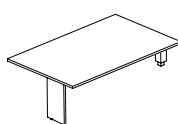

Fixed Rectangular Meeting Peninsula  
(BC\_FR)

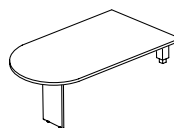

Fixed D-Shape Meeting Peninsula  
(BC\_FD)

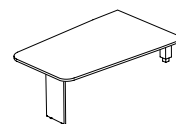

Fixed Tapered Meeting Peninsula  
(BC\_FT)

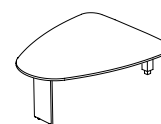

Fixed Diamond Meeting Peninsula  
(BC\_FP)

# understanding workwall kneespace modules (continued)

## workwall kneespace modules (continued)

### full-modesty style

Can be specified with or without Extension Panel, three styles available:

- No Extension Panel (N)
- With Extension Panel – Solid Colors/Horizontal (E)
- With Extension Panel – Vertical (V)

for more details, refer to page [345](#)

#### Workwall Kneespace Module for Full-Modesty Height-Adjustable Run-Off (BHKHM)

Only product illustrated below can be installed on this module:

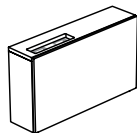

No Extension Panel (N)

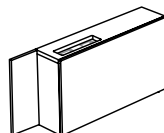

With Extension Panel (E or V)

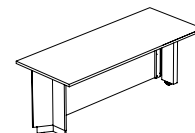

Full-Modesty Height-Adjustable Run-Off (BF\_R)

#### Workwall Kneespace Module for Full-Modesty Height-Adjustable Extended or "L" Run-Off (BHKHL)

Only products illustrated below can be installed on this module:

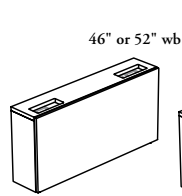

46" or 52" wb

No Extension Panel (N)

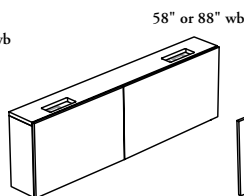

58" or 88" wb

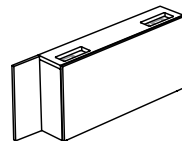

With Extension Panel (E or V)

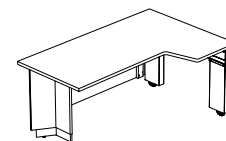
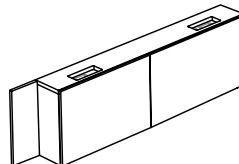

Full-Modesty Height-Adjustable Run-Off (BF\_E)

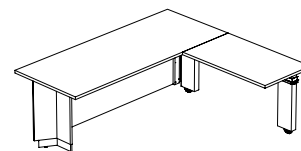

Full-Modesty Height-Adjustable Run-Off (BF\_L)

#### Workwall Kneespace Module for Full-Modesty Fixed Run-Off (BHKFR)

Only product illustrated below can be installed on this module:

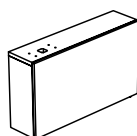

No Extension Panel (N)

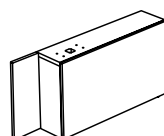

With Extension Panel (E or V)

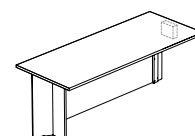

Full-Modesty Fixed Run-Off (BF\_MR)

# workwall kneespace module components

The following should be considered when planning with Expansion Casegoods Workwall Kneespace Modules for Height-Adjustability or Fixed Worksurfaces.

components & cable routing for fixed-height configurations (standard or full-modesty (shown))

FRONT VIEW

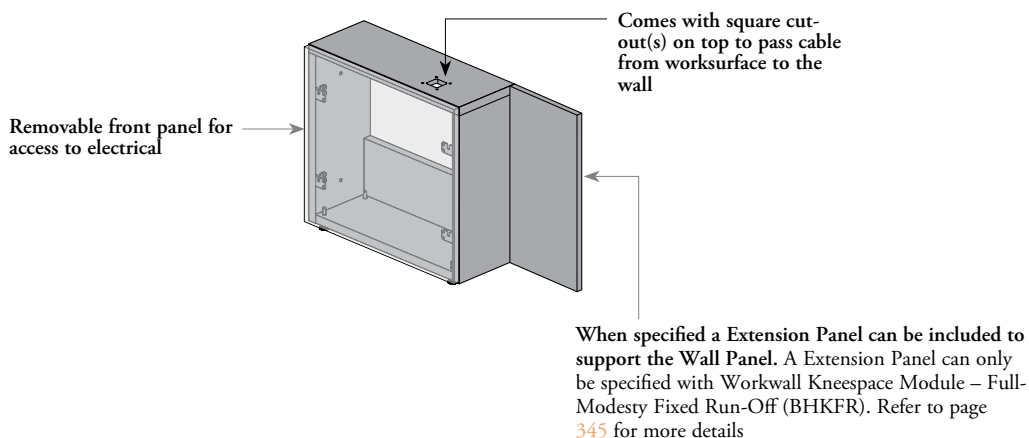

BACK VIEW

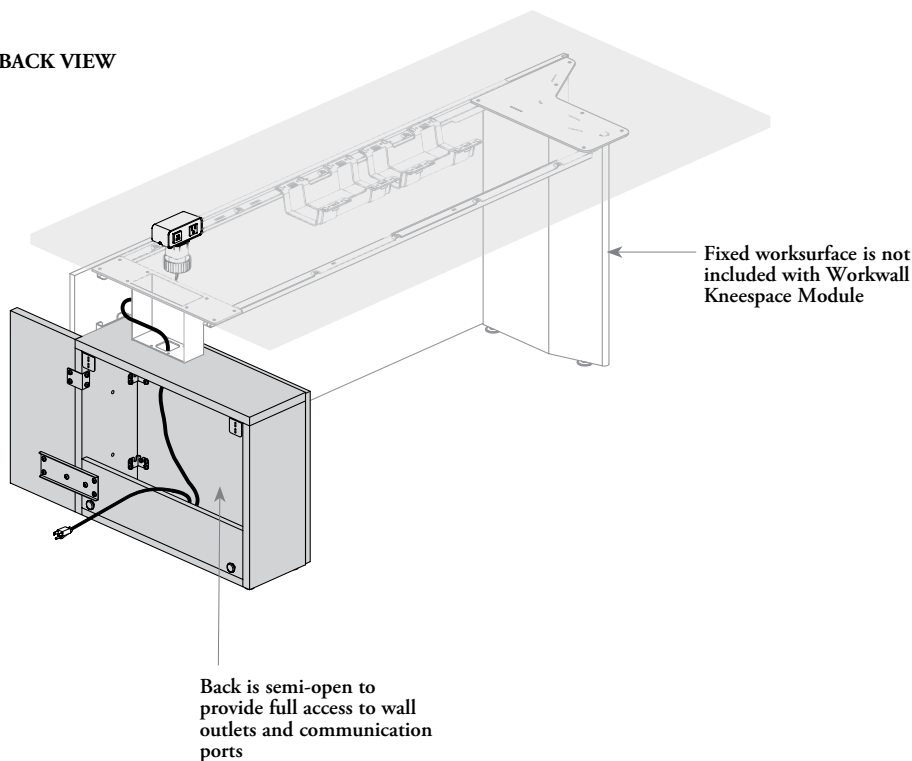

# workwall kneespace module components (continued)

## components & cable routing for height-adjustable configurations (standard (shown) or full-modesty style)

A Extension Panel can be specified to support a Wall Panel. Refer to the following page for more details

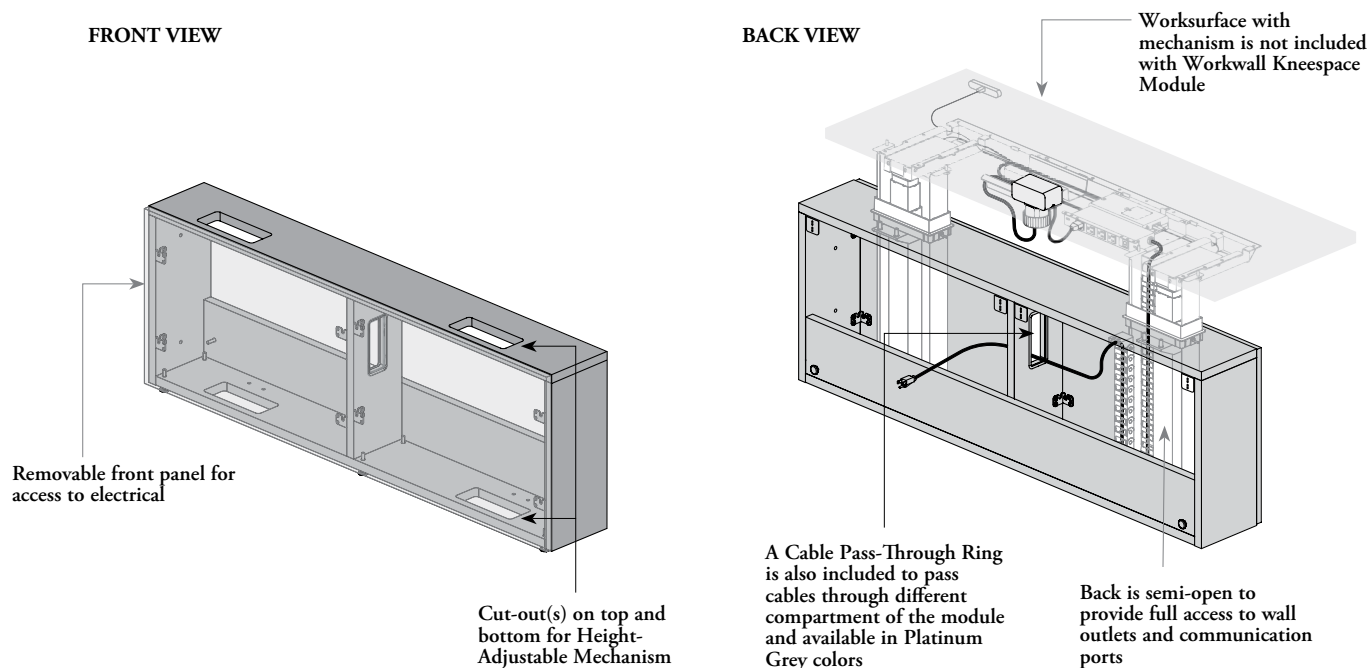

## user kneespace

(Height-adjustable Rectangular Worksurfaces (BH\_RL or BH\_RC) (Shown), Height-Adjustable L-Shape for Workstations (BH\_LB, BH\_L or BH\_LT) and Full-Modesty Height-Adjustable L-Shape Run-Off – Offset Base (BF\_L))

21" Worksurface Width

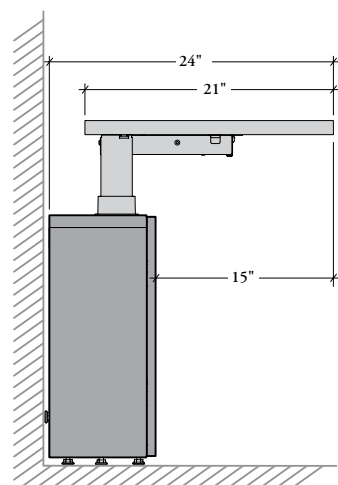

24" Worksurface Width

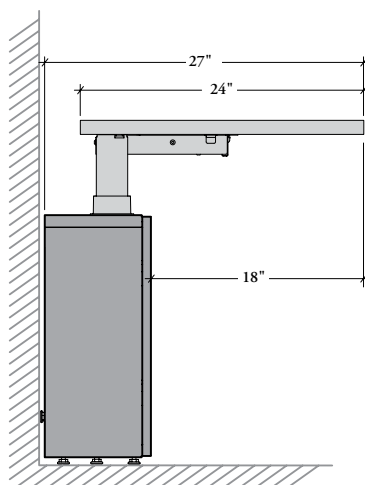

27" Worksurface Width

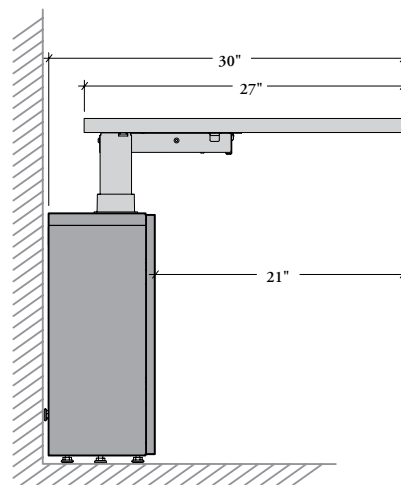



# workwall kneespace module components (continued)

## extension panel applications for full-modesty style only– fixed-height or height-adjustable configurations

Three Extension Panel options are available:

### no extension panel (N)

Workwall Kneespace Module – Full-Modesty can be specified without Extension Panel when:

- no Wall Panel is needed on top of the module
- no storage is needed on the visitor side

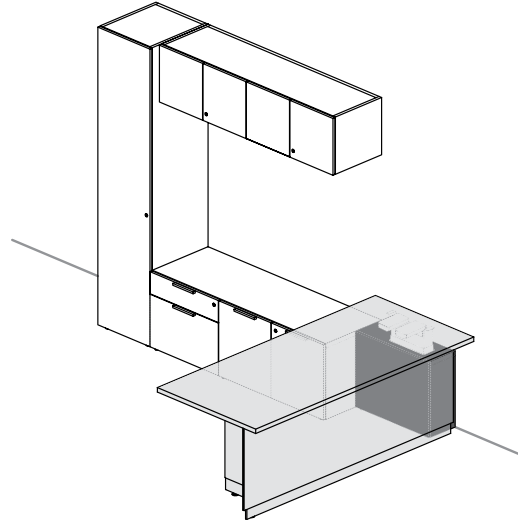

### with extension panel – solid colors/horizontal (E) or – vertical (V)

Three Extension Panel are available to fit with Wall Panel Grain:

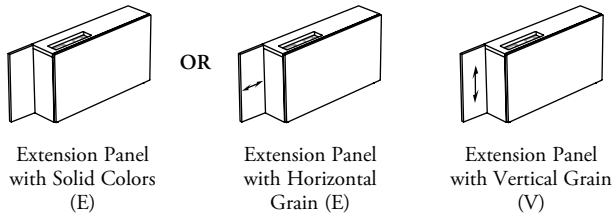

The Extension Panel has two purposes:

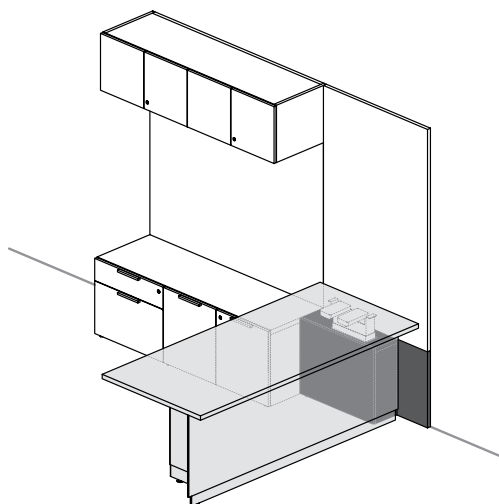

It must be specified when a wall panel is installed on a Workwall Kneespace Module for Full-Modesty. The Extension Panel **not** only offers support to the wall panel but also ensures that the worksurface depth remains completely enclosed within the wall panel

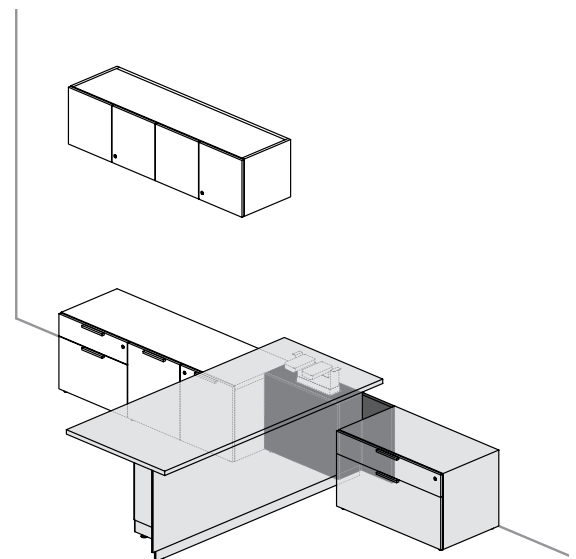

It provides a continuous aesthetic with storage on visitor side. It also preserves the mandatory 1-inch pinch gap for height-adjustable worksurface when specified with storage

## workwall kneespace module basics

Expansion Casegoods Workwall Kneespace Modules can be used with Fixed and/or Height-Adjustable Worksurfaces to create diverse workstation configurations.

- ◆ The installation of the Workwall Kneespace Modules for Height-Adjustability relies on the structural wall it is anchored to. The warranty on the Workwall Kneespace Module applies only to the product itself, and not to the durability of the wall. Installation on building/structural walls that do not meet local code requirements will affect the safety and durability of the product
- The Workwall Kneespace Modules (BHKHW, BHKHM, BHKHL and BHKHF) must always be anchored to the wall. Depending on the wall condition or the geographic region, especially for seismic zones, an engineer of record could have to evaluate the wall capabilities to support this product
- In addition to wall anchoring, when planning with Workwall Kneespace Module – Full-Modesty (BHKFR or BHKHM) it is recommended to link the module to another Workwall Storage or Freestanding Storage on the user side for optimal stiffness (hardware supplied)
- When using a Workwall Kneespace Module – Fixed Worksurface (BHKFW), wall anchored is recommended for optimal stiffness but is **not** mandatory
- When using a Workwall Kneespace Module – Full-Modesty Fixed Run-Off (BHKFR), it must be wall anchored

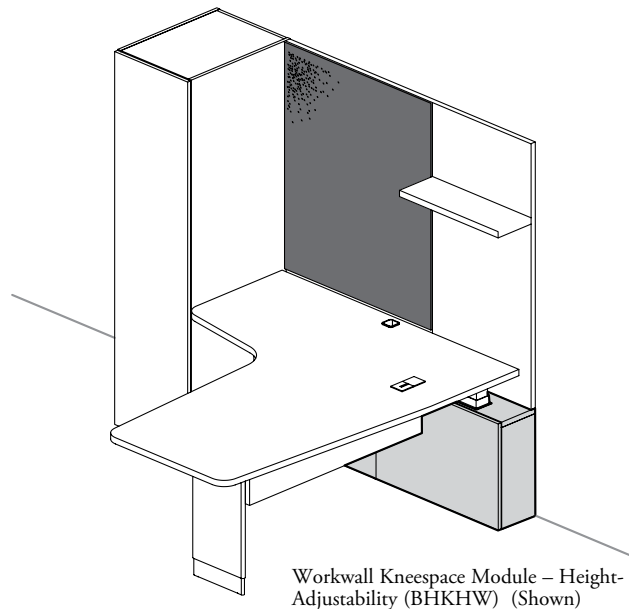

- All Workwall Kneespace Module styles (Standard or Full-Modesty) provide maximum knee clearance
- Workwall Kneespace Module **does not** require attachment to another Freestanding or Workwall Storage unit. However, when connected together, they ensure a perfect installation. Refer to page 395 for more details
- Only a freestanding mid-height storage can be used in front of the module
- Includes removable front panel to access the wall behind and to allow cable management
- Height: 21"
- Depth: 9"
- Include levelers with a 1" adjustment range
- A Wall Panel is **not** mandatory for mounting fixed or Height-Adjustable Worksurface

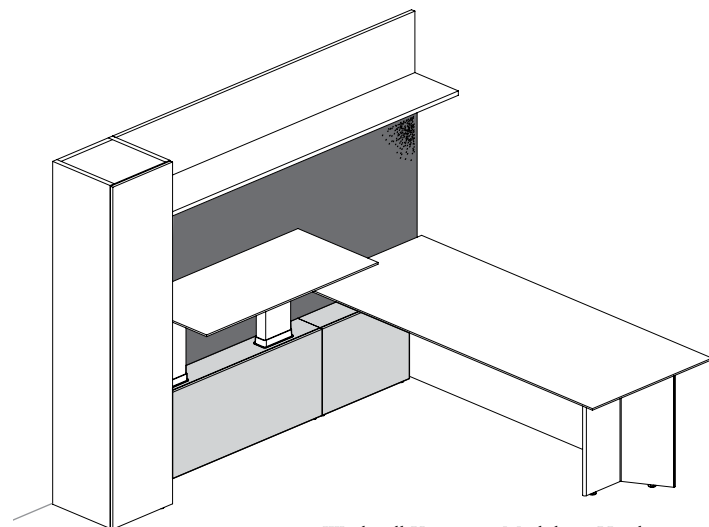

# workwall kneespace module basics (continued)

## standard style

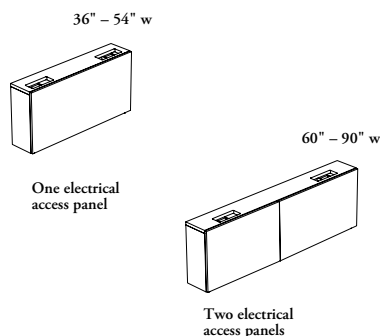

### Workwall Kneespace Module – Height-Adjustability (BHKHW)

- Widths: 36" to 90" (6" increments)
- Can be used with:
  - Height-Adjustable Rectangular Worksurfaces – Mid-Height (BH\_RL or BH\_RC)
  - Height-Adjustable Peninsulas – Bevel Post Leg (BH\_RP, BH\_TP or BH\_PE)
  - Height-Adjustable L-Shaped Worksurfaces (BH\_LB, BH\_L or BH\_LT)
  - Height-Adjustable Meeting Peninsulas (B\_HRW, B\_HDW, B\_HBW or B\_HPW)
- On-module application only

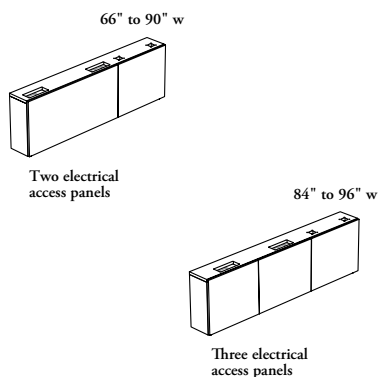

### Workwall Kneespace Module – Height-Adjustability and Fixed Worksurface (BKHCF)

- Widths: 66" to 96" (6" increments)
- Can accommodate Run-Off Depths: 24" to 36" (6" increments)
- Run-Off Configuration:
  - Left (L)
  - Right (R) (Shown)
- Can be used with:
  - Height-Adjustable Rectangular Worksurfaces – Mid-Height (BH\_RL or BH\_RC)
  - Fixed Run-Off – Mid-Height (BM\_R)
  - Fixed Meeting Peninsulas (BC\_FR or BC\_FD)

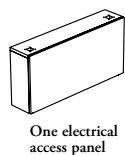

### Workwall Kneespace Module – Fixed Worksurface (BHKFW)

- Can accommodate Worksurface Depths: 36" to 60" (6" increments)
- Can be used with:
  - Fixed Run-Off – Mid-Height (BM\_R)
  - Fixed Extended Tapered Peninsula – Mid-Height (BM\_EP)
  - Fixed Meeting Peninsulas (BC\_FR, BC\_FD, BC\_FT or BC\_FP)

# workwall kneespace module basics (continued)

## full-modesty style

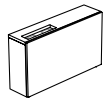

One electrical access panel and No Extension Panel

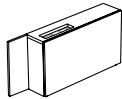

One electrical access panel and with Extension Panel

### Workwall Kneespace Module – Full-Modesty Height-Adjustable Run-Off (BHKHM)

- Can accommodate Worksurface Depths: 28" or 34"
- Extension Panel (for details, refer to page 345):
  - No Extension Panel (N)
  - With Extension Panel – Horizontal or Solid Colors (Shown) (E)
  - With Extension Panel – Vertical (V)
- Configuration:
  - Left Handed (L) (Shown)
  - Right Handed (R)
- Can only be used with:
  - Full-Modesty Height-Adjustable Run-Off – Offset Base (BF\_R)

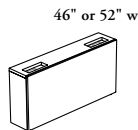

One electrical access panel and No Extension Panel

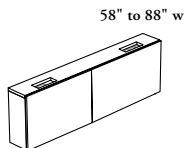

Two electrical access panel and No Extension Panel

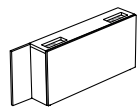

One electrical access panel and with Extension Panel

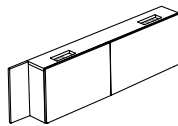

Two electrical access panel and with Extension Panel

### Workwall Kneespace Module – Full-Modesty Height-Adjustable Extended or "L" Run-Off (BHKHL)

- Can accommodate Worksurface Depths A: 29" or 35"
- Can accommodate Worksurface Widths B: 46" to 88" (6" increments)
- Extension Panel (for details, refer to page 345):
  - No Extension Panel (N)
  - With Extension Panel – Horizontal or Solid Colors (Shown) (E)
  - With Extension Panel – Vertical (V)
- Configuration:
  - Left Handed (L) (Shown)
  - Right Handed (R)
- Can be used with:
  - Full-Modesty Height-Adjustable Extended Run-Off – Offset Base (BF\_E)
  - Full-Modesty Height-Adjustable L-Shape Run-Off – Offset Base (BF\_L)

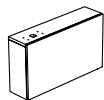

One electrical access panel and No Extension Panel

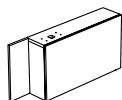

One electrical access panel and with Extension Panel

### Workwall Kneespace Module – Full-Modesty Fixed Run-Off (BHKFR)

- Can accommodate Worksurface Depths: 30" or 36"
- Extension Panel (for details, refer to page 345):
  - No Extension Panel (N)
  - With Extension Panel – Horizontal or Solid Colors (Shown) (E)
  - With Extension Panel – Vertical (V)
- Configuration:
  - Left Handed (L) (Shown)
  - Right Handed (R)
- Can only be used with:
  - Full-Modesty Fixed Run-Off – Offset Base (BF\_MR)

# workwall kneespace module removable front panel widths

The following illustrates the nominal width of the Workwall Kneespace Module removable front panel.

## workwall kneespace module – height-adjustability (BHKHW)

- Come with two compartments
- Include one removable front panel for two compartments

36" Width

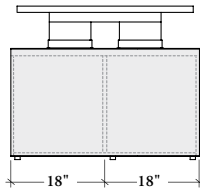

42" Width

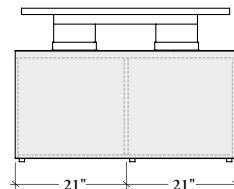

48" Width

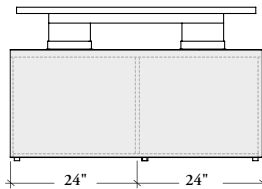

54" Width

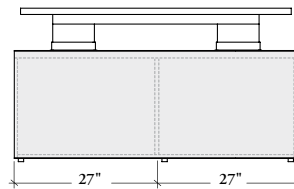

60" Width

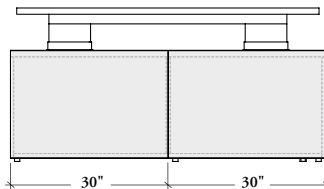

66" Width



- Come with two compartments
- Include two removable front panels (one panel for each compartments)

72" Width

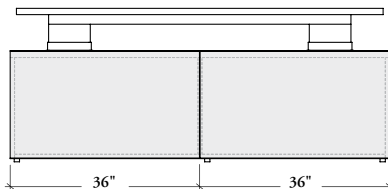

78" Width

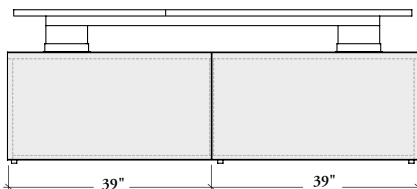

84" Width

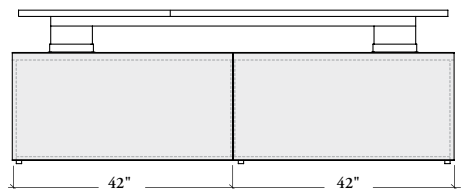

- Come with two compartments
- Include two removable front panels (one panel for each compartments)

90" Width

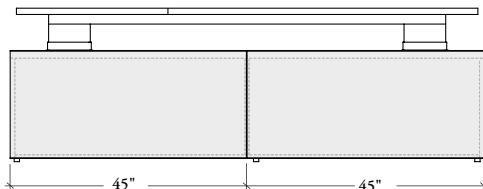

# workwall kneespace module removable front panel widths (continued)

## workwall kneespace module – height-adjustability and fixed worksurface (BHKHF)

Both sides of the panel below the Fixed-Run-Off – Mid-Height are aligned with worksurface width

- Come with two compartments
  - Include two removable front panels (one panel for each compartments)
- Come with three compartments
  - Include two removable front panels (one panel for compartment under Fixed-Run-Off – Mid-Height and one panel for two other compartments)
- Come with three compartments
  - Include three removable front panels (one panel for each compartments)

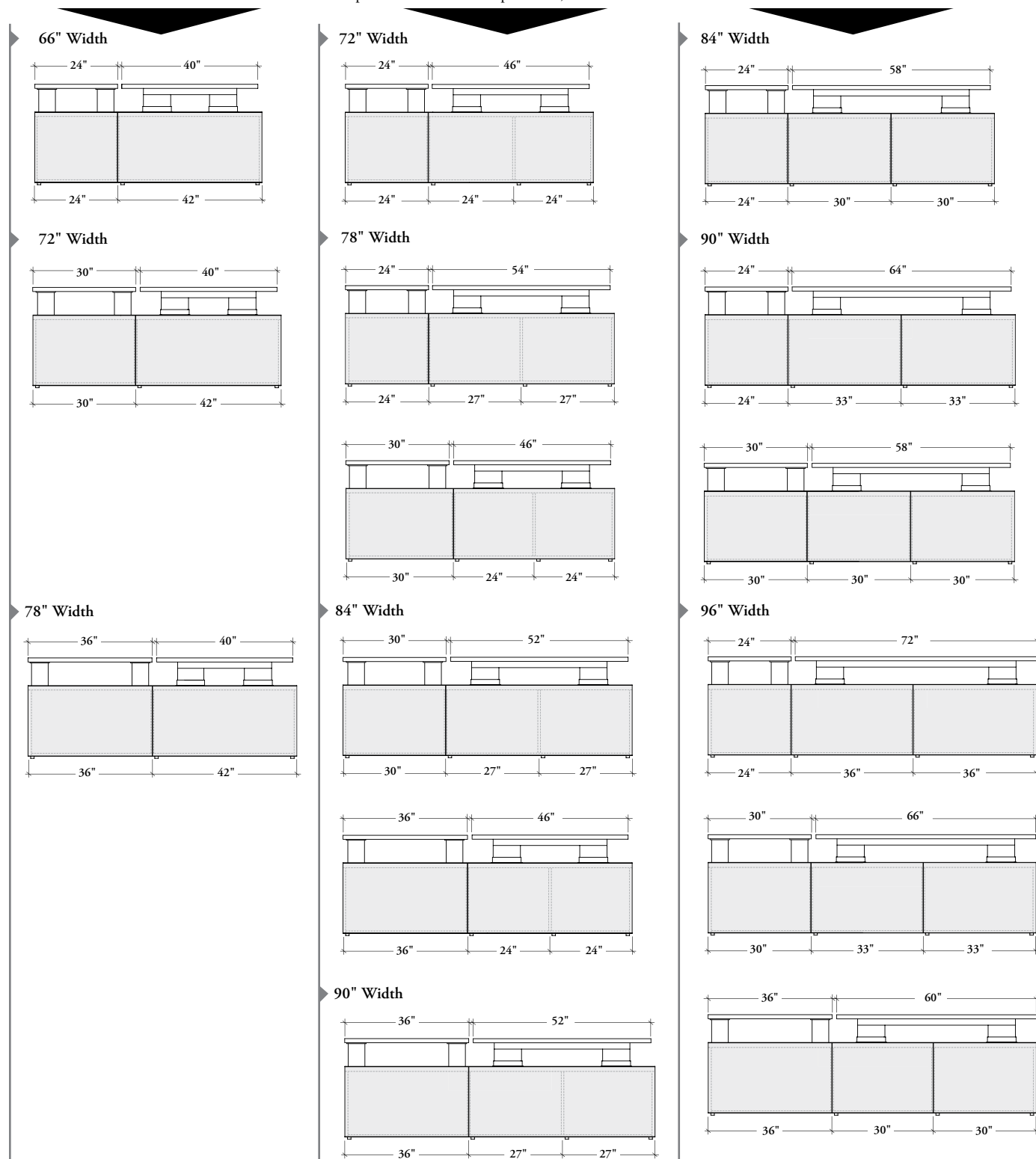

# workwall kneespace module removable front panel widths (continued)

## workwall kneespace module – fixed worksurface (BHKFW)

All Fixed Worksurface depths must be specified same width as kneespace module, except for Fixed Diamond Meeting Peninsula (BC\_FP)

- Come with two compartments
- Include one removable front panel for two compartments

36" Width

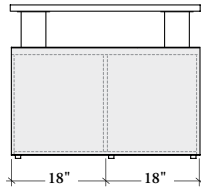

42" Width

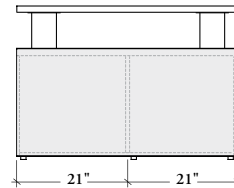

48" Width

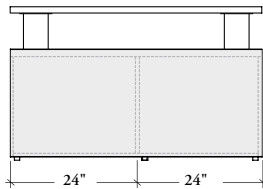

54" Width

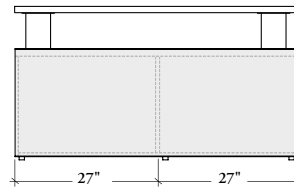

60" Width



- Come with two compartments
- Include two removable front panels for two compartments

# workwall kneespace module removable front panel widths (continued)

workwall kneespace module – full-modesty height-adjustable run-off (BHKHM) without (N) or with extension panel (E or V) (shown)

- Comes with one compartment
- Includes one removable front panel

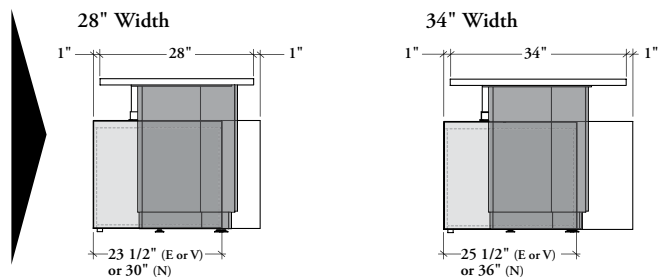

workwall kneespace module – full-modesty height-adjustable extended or "L" run-off (BHKHL) without (N) or with extension panel (E or V) (shown)

- Come with two compartments
- Include one removable front panel for two compartments

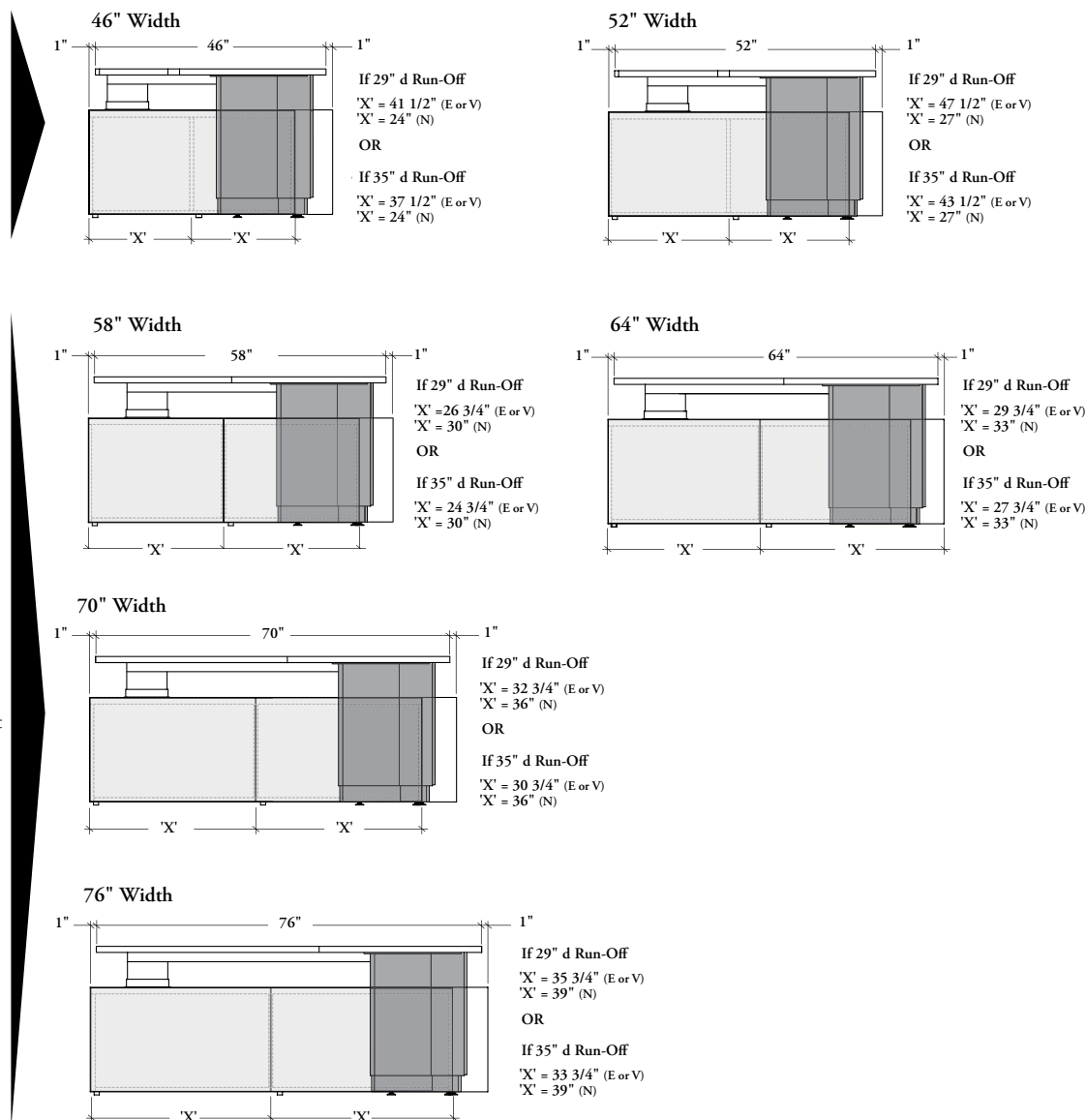

- Come with two compartments
- Include two removable front panels (one panel for each compartment)



# workwall kneespace module removable front panel widths (continued)

workwall kneespace module – full-modesty height-adjustable extended or "L" run-off (BHKHL) without (N) or with extension panel (E or V) (shown) (continued)

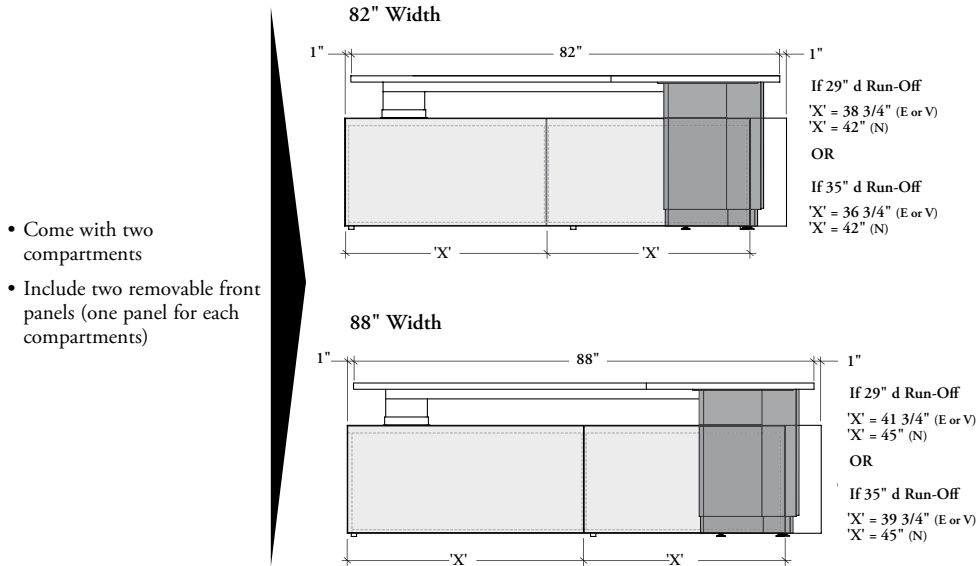

workwall kneespace module – full-modesty fixed run-off (BHKFR) without (N) or with extension panel (E or V) (shown)

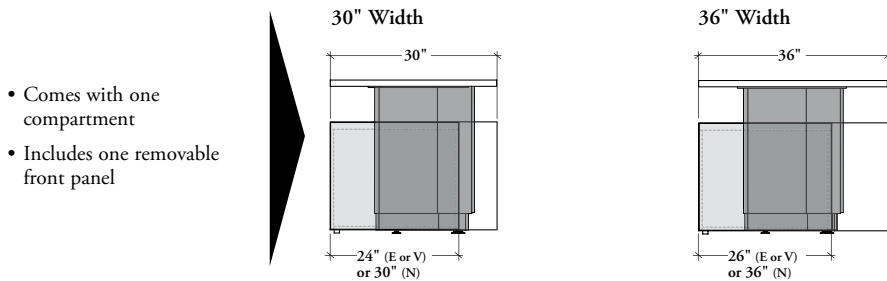

## understanding workwall bookcases – mid – 21" h

All dimensions in this section are nominal

### workwall bookcases – mid – 21" h

- Two styles can be specified:
  - **Standard:**  
21" high Workwall Bookcases (BSMO)
  - **Supporting :**  
Fixed or Height-Adjustable Worksurfaces – Mid – 21" h (BSMOBW or BSMOBH)
- Can support Wall Panels (B\_WCC, B\_WCO, B\_WAA, B\_WOO, B\_WMD, B\_WMO or B\_WMM)
- For more details on mid-height Workwall Bookcase Applications, refer to page 361

### standard style

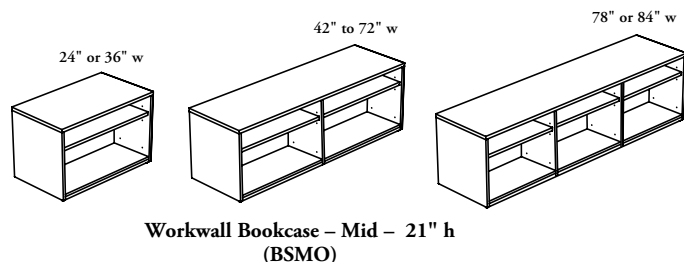

### supporting style

#### Workwall Bookcase – Fixed Worksurface – Mid – 21" h (BSMOBW)

Only products illustrated below can be installed on this module:

For more details on these products listed below, refer to Multi-Level Workstations Section

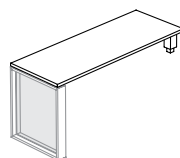
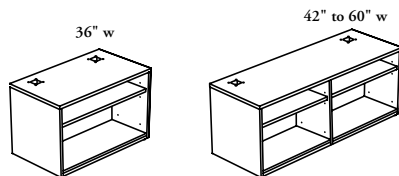

Fixed Run-Off – Mid-Height  
(BM\_R)

For more details on this product, refer to page 92 and following pages

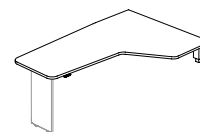

Fixed Extended Tapered – Mid-Height  
(BM\_EP)

For more details on this product, refer to page 93 and following pages

For more details on these products listed below, refer to Meeting Tables Section

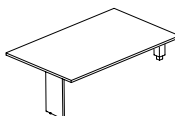

Fixed Rectangular Meeting Peninsula  
(BC\_FR)

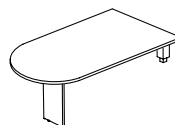

Fixed D-Shape Meeting Peninsula  
(BC\_FD)

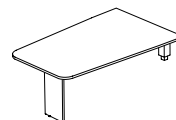

Fixed Tapered Meeting Peninsula  
(BC\_FT)

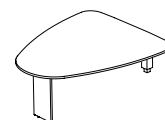

Fixed Diamond Meeting Peninsula  
(BC\_FP)

# understanding workwall bookcases – mid – 21" h (continued)

workwall bookcases – mid – 21" h (continued)

supporting style (continued)

Workwall Bookcase – Height-Adjustable Worksurface – Mid – 21" h (BSMOBH)

Only products illustrated below can be installed on this module:

For more details on these products listed below, refer to Multi-Level Workstations Section

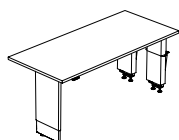
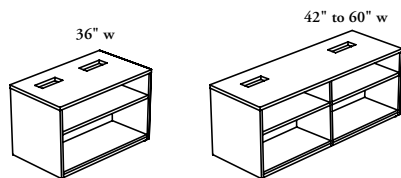

Height-Adjustable  
Rectangular Peninsula  
(BH\_RP)

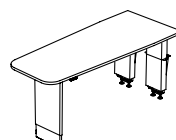

Height-Adjustable  
Tapered Peninsula  
(BH\_TP)

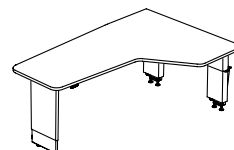

Height-Adjustable Extended  
Tapered Peninsula  
(BH\_PE)

For more details on these products listed below, refer to Meeting Tables Section

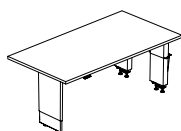

Height-Adjustable  
Rectangular Meeting  
Peninsula  
(B\_HRW)

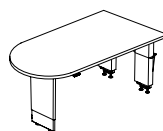

Height-Adjustable  
D-Shape Meeting  
Peninsula  
(B\_HDW)

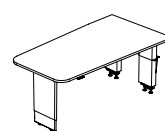

Height-Adjustable  
Tapered Meeting  
Peninsula  
(B\_HBW)

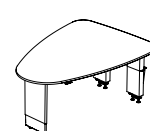

Height-Adjustable  
Diamond Meeting  
Peninsula  
(B\_HPW)

# workwall bookcase – mid – 21" h – components

The following should be considered when planning with Expansion Casegoods mid-height Workwall Bookcases for Height-Adjustability or Fixed Worksurfaces.

components & cable routing for fixed-height configurations (standard or supporting (shown) style)

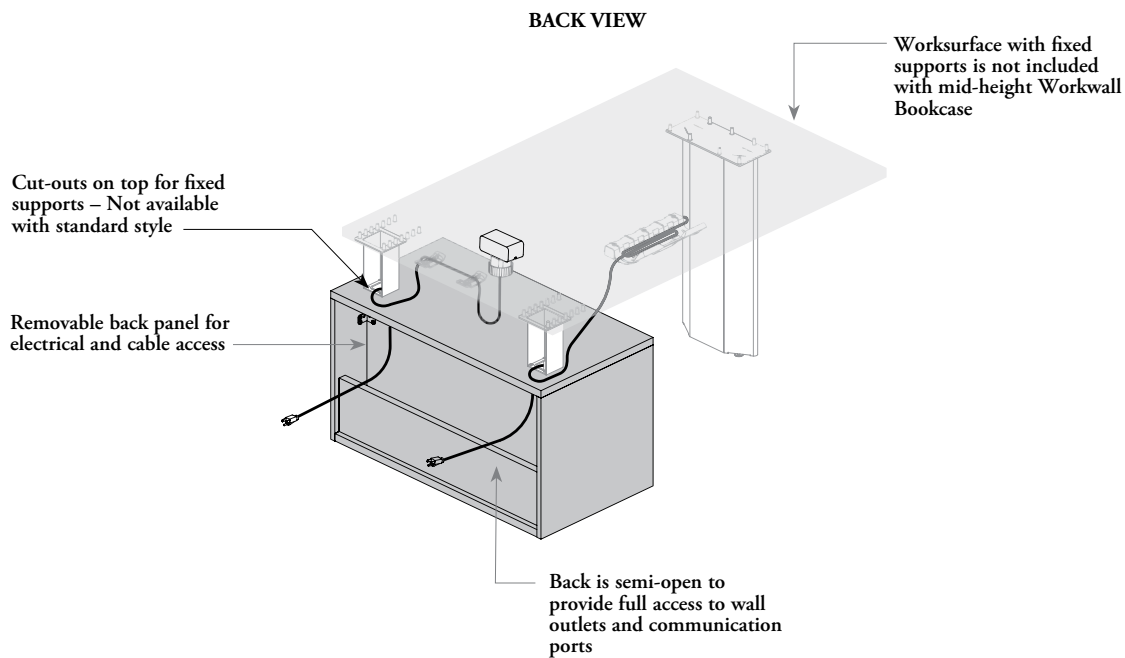

components & cable routing for height-adjustable configurations (standard or supporting (shown) style)

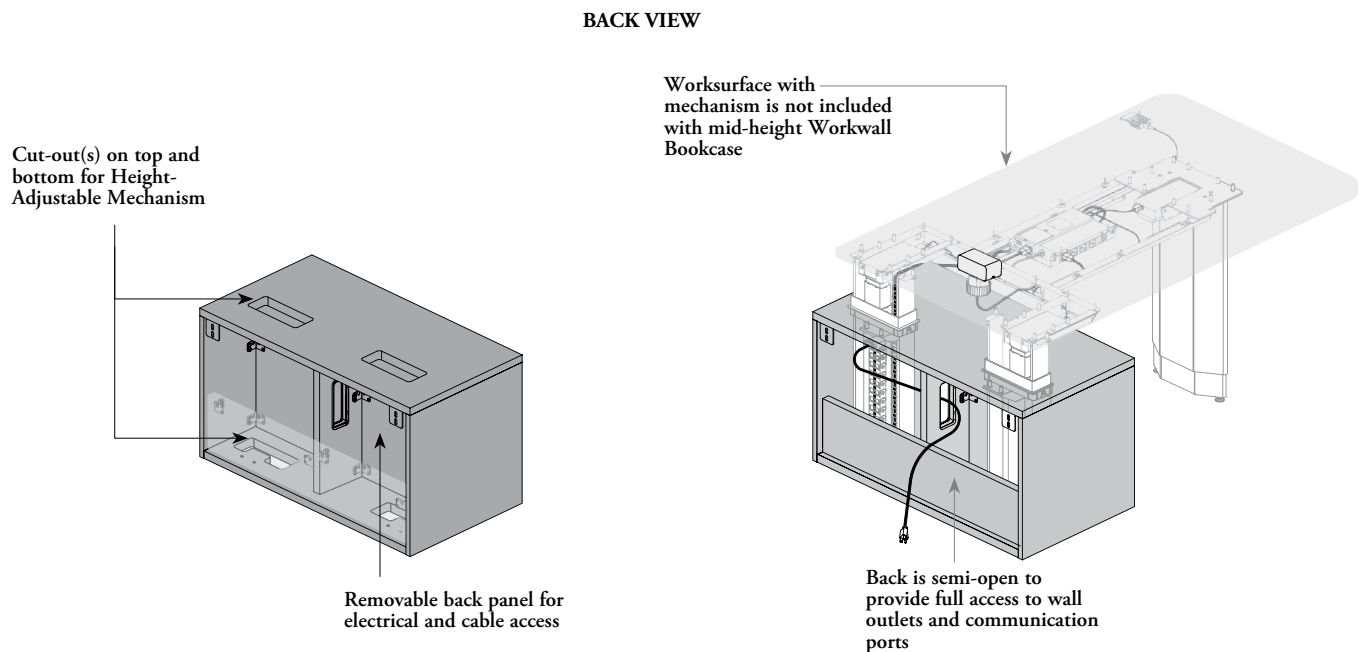

## workwall bookcase – mid – 21" h – basics

Expansion Casegoods mid-height Workwall Bookcase can be used alone or with fixed or height-adjustable worksurfaces to create diverse workstation configurations.

- ◆ The mid-height Workwall Bookcase provides a variety of option to create the optimal combination of functionality for the office or meeting room
- Can accommodate fixed or height adjustable worksurfaces
- Must be against a building wall
- Workwall Bookcase – Mid – 21" h (BSMO) can be used freestanding, **no** wall anchoring is required
- When using a mid-height Workwall Bookcase for Fixed or Height-Adjustable Worksurface (BSMOBW or BSMOBH), wall anchored is recommended for optimal stiffness but is **not** mandatory

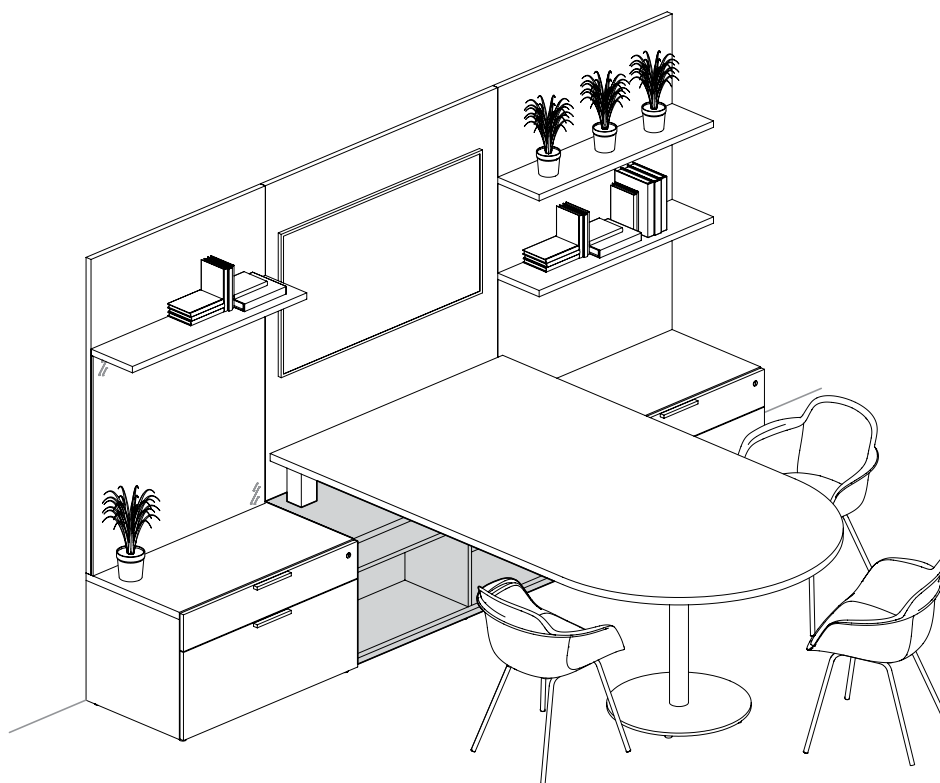

Workwall Bookcase – Fixed Worksurface  
– Mid – 21" h (BSMOBH) (Shown)

- The mid-height Workwall Bookcases provide a base support and storage for a fixed or height-adjustable worksurface. Ideal for small meeting room
- The Mid-height Workwall Bookcase **does not** require attachment to another Freestanding or Workwall Storage unit. However, when connected together, they ensure a perfect installation. Refer to page 395 for more details
- Fixed worksurface depth must match the bookcase width, except for Fixed Diamond Meeting Peninsula (BC\_FP)
- Storage is non-handed
- Height: 21"
- Open section with adjustable shelf configuration has holes in 1 1/4" intervals on the inside walls for shelf height adjustment
- Additional shelves **cannot** be specified for these products
- Include levelers with a 1" adjustment range

# workwall bookcase – mid – 21" h – basics (continued)

## standard style

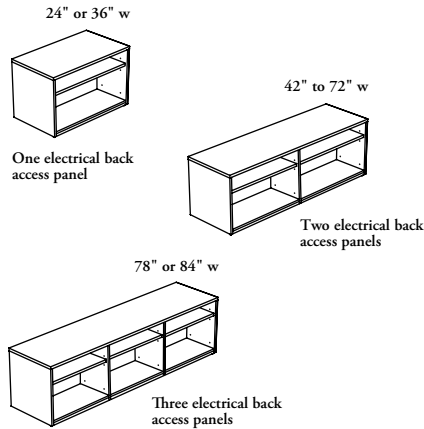

### Workwall Bookcase – Mid – 21" h (BSMO)

- Depths: 20" or 24"
- Widths: 24" to 84" (6" increments)
- Each open compartment comes with one adjustable shelf

## supporting style

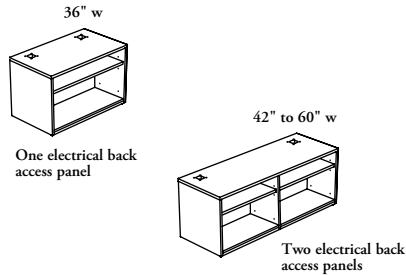

### Workwall Bookcase – Fixed Worksurface – Mid – 21" h (BHKHW)

- Only available in 20" depth
- Widths: 36" to 60" (6" increments)
- Can be used with:
  - Fixed Run-Off – Mid-Height (BM\_R)
  - Fixed Extended Tapered Peninsula – Mid-Height (BM\_EP)
  - Fixed Meeting Peninsulas (BC\_FR, BC\_FD, BC\_FT pr BC\_FP)
- Each open compartment comes with one adjustable shelf

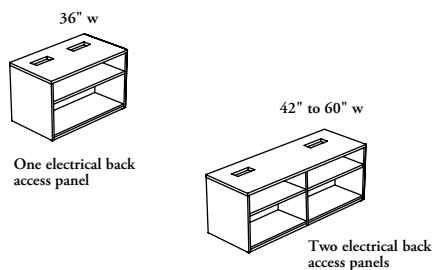

### Workwall Bookcase – Height-Adjustable Worksurface – Mid – 21" h (BHKHW)

- Only available in 20" depth
- Widths: 36" to 60" (6" increments)
- Can be used with:
  - Fixed Run-Off – Mid-Height (BM\_R)
  - Height-Adjustable Peninsulas – Bevel Post Leg (BH\_RP, BH\_TP or BH\_PE)
  - Height-Adjustable Meeting Peninsulas (B\_HRW, B\_HDW, B\_HBW or B\_HPW)
- Each open compartment comes with one adjustable shelf

# workwall bookcase – mid – 21" – open compartment widths

The following illustrates Expansion Casegoods mid-height Workwall Bookcases for Fixed Worksurfaces or Height-Adjustability open sections nominal widths.

Workwall Bookcase – Mid – 21" h (BSMO) (Shown),  
 Workwall Bookcase – Fixed Worksurface – Mid – 21" h (BSMOBW) or  
 Workwall Bookcase – Height-Adjustable Worksurface – Mid – 21" h (BSMOBH)

- Comes with one open compartment
- Includes one removable back access panel

24" Width

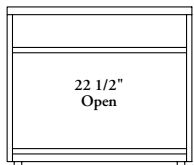

30" Width

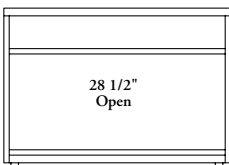

36" Width

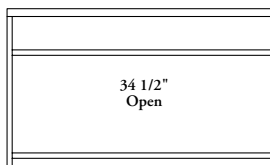

42" Width

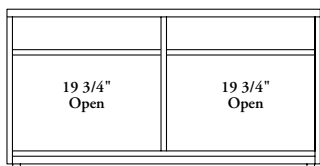

48" Width

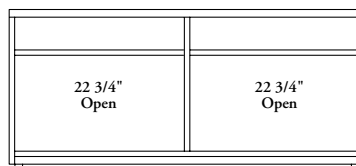

- Comes with two open compartments
- Includes two removable back access panels

54" Width

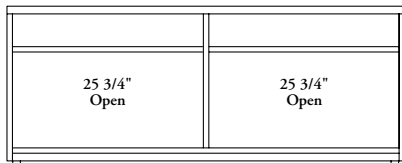

60" Width

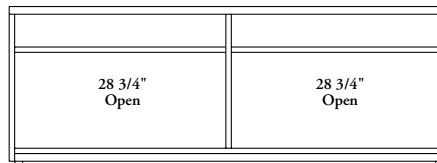

66" Width

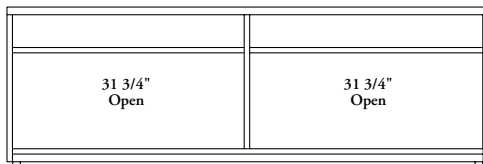

72" Width

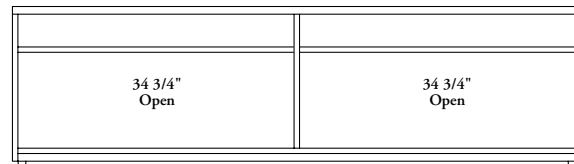

78" Width

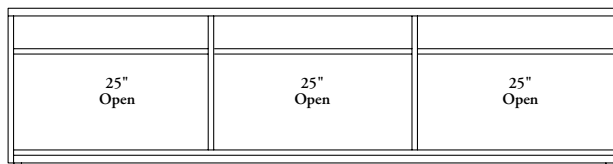

84" Width

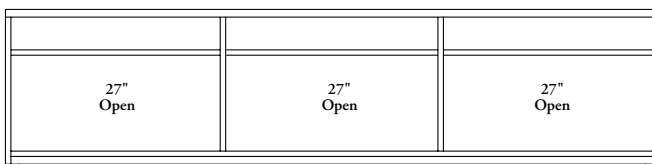

- Comes with three open compartments
- Includes three removable back access panels

# workwall bookcase – mid –21" h – interior clearance

The following outline the interior clearance available for all mid-height Workwall Bookcases.

## interior clearance height

- The open section features holes at 1 1/4" intervals on the interior walls, allowing for convenient adjustment of shelf height
- The interior height dimension is 17 5/8" for all mid-height Workwall Bookcases

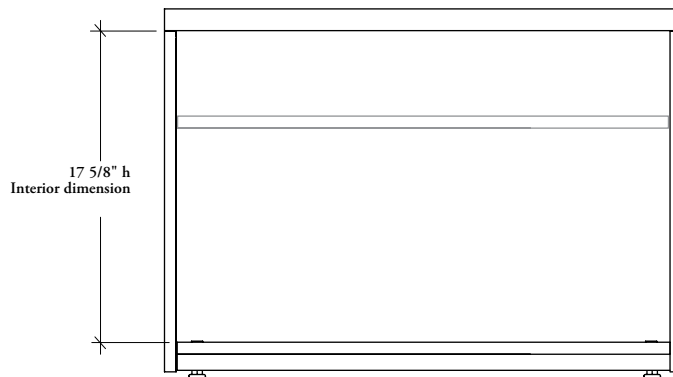

## interior clearance depth

Standard or Fixed Worksurface:  
mid-height Workwall Bookcases (BSMO) and Workwall Bookcases – Fixed Worksurface (BSMOBW)

Height-Adjustable Worksurface:  
mid-height Workwall Bookcases – Height-Adjustable Worksurface (BSMOBH)

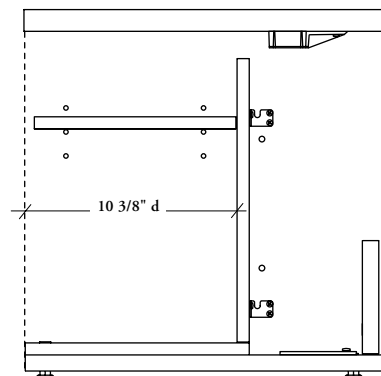
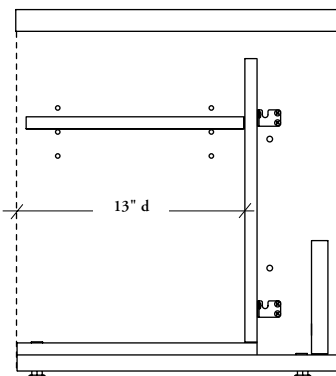



# planning with worwall kneespace modules & workwall bookcases – mid – 21" h

The following should be considered when planning with Expansion Casegoods Workwall Kneespace Modules & Workwall Bookcases.

- ◆ Depending on the worksurface shape, the Workwall Kneespace Module or Bookcase required special consideration when planning workstation set-up
- Other special considerations must be taken when planning with Fixed or Height-Adjustable Worksurfaces, or with Full-Modesty Fixed or Height-Adjustable Worksurfaces. For more details, refer to Multi-Level Workstation section
- Other special considerations must be taken when planning with Fixed or Height-Adjustable Meeting Peninsulas. For details, refer to Meeting Tables section

workwall kneespace module – height-adjustability (BHKHW) (shown) or  
workwall bookcase – height adjustable worksurface – mid – 21" h (BSMOBH)

with height-adjustable meeting peninsulas

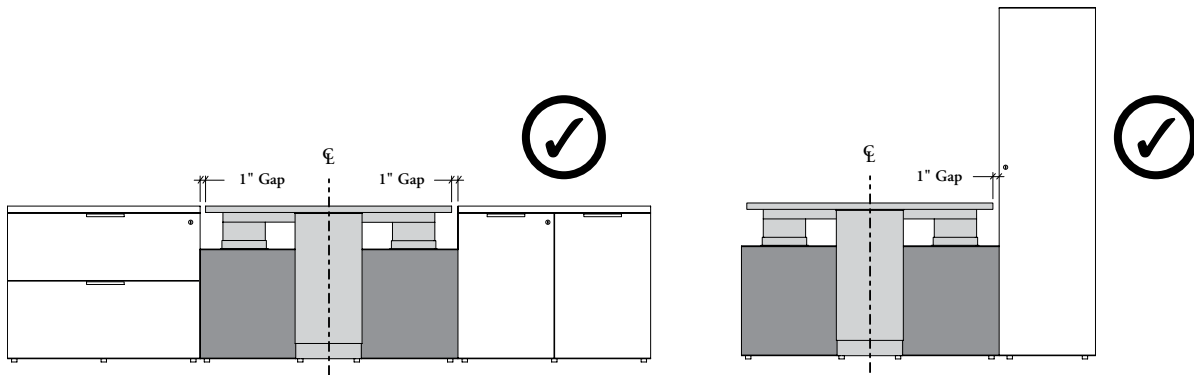

When the Workwall Kneespace Module or Bookcase is used with a Height-Adjustable Meeting Peninsula (B\_HRW, B\_HDW or B\_HBW) the combination of products will automatically ensure the 1" minimum clearance all around worksurface

with height-adjustable peninsula (BH\_RP) or height-adjustable tapered peninsula (BH\_TP)

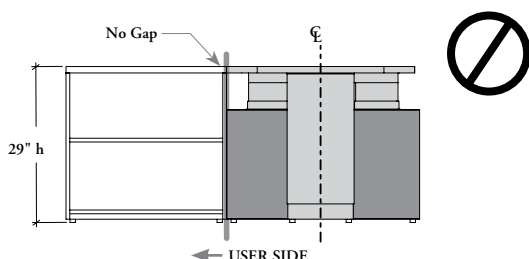
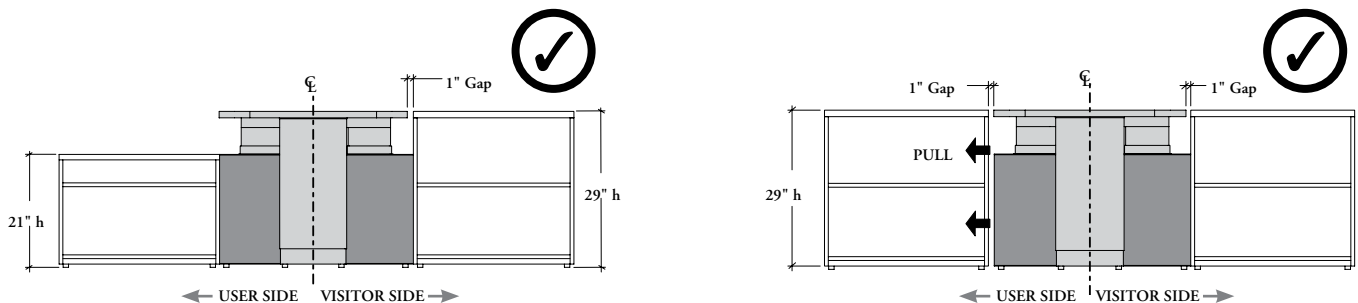

**WARNING:** When used with Height-Adjustable Peninsula (BH\_RP) or Height-Adjustable Tapered Peninsula (BH\_TP), surrounding storage on user side **MUST BE** specified Mid-Height Datum (21" height) to avoid conflict with worksurface. If **not**, 1" pinch gap must be preserved

# planning with worwall kneespace modules & workwall bookcases – mid – 21" h (continued)

workwall kneespace module – height-adjustability (BHKHW) (shown) or  
workwall bookcase – height adjustable worksurface – mid – 21" h (BSMOBH) (continued)

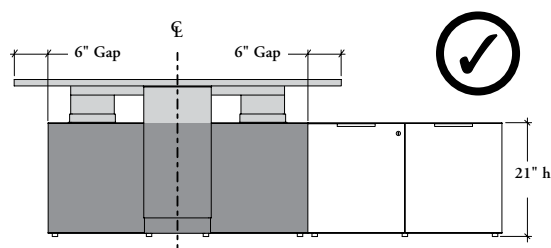

- When the Workwall Kneespace Module or Bookcase is used with the Height-Adjustable Diamond Meeting Peninsula (B\_HWP), the worksurface exceed the kneespace by 6" on each side
- Surrounding storage must be specified mid-height (21" height) to avoid conflict with the worksurface

workwall kneespace module – fixed worksurface (BHKFW) (shown) or  
workwall bookcase – fixed worksurface – mid – 21" h (BSMOBW)

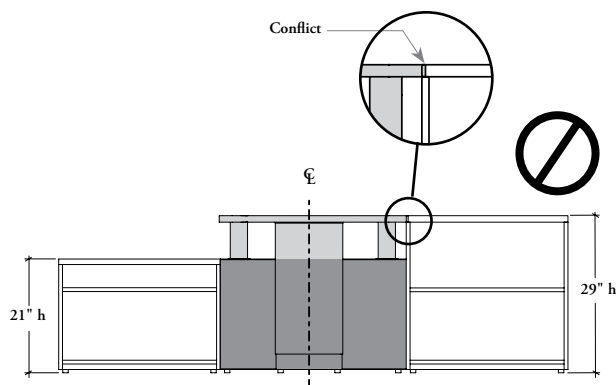
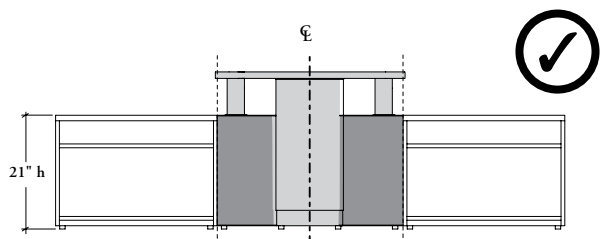

- When used with Fixed Run-Off – Mid Height (BM\_R) (Shown) or Fixed Extended Tapered Peninsula (BM\_EP), surrounding storage on both side **MUST BE** specified Mid-Height Datum (21" height) to avoid conflict with worksurface. This conflict will **not** occur with Fixed Meeting Peninsula (BC\_FR, BC\_FS or BC\_FT), since the worksurface will **not** exceed the module

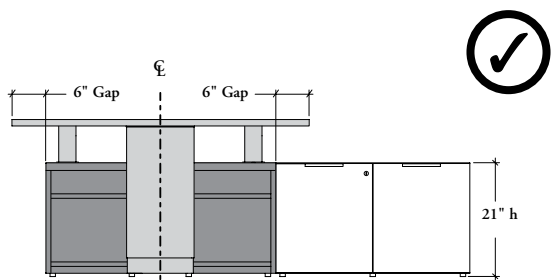

- When the module or bookcase (Shown) is used with the Fixed Diamond Meeting Peninsula (BC\_FP), the worksurface exceed by 6" on each side
- Surrounding storage must be specified mid-height (21" height) to avoid conflict with the worksurface

# workwall storage – integral top – 29" h – basics

- ❗ When using a 29" high Workwall Storage with Integral Top (BSBOT, BSOBC, BSCT, BSDC, BSLFT, BSLFC, BSPT and BSPC), **no** wall anchoring is needed
- Door and drawers come with Rectilinear Pull (9) only, except for storage (BSCT) can also be specified without pulls
- **Cannot** be installed under a desk
- These storage come with a closed back and **do not** provide any space for wire management or wall outlet clearance
- **Cannot** support one end of a semi-supported worksurface

## Storage with Integral Top

- Eight storage styles are available:
  - 2 open compartments, Straight (BSOBT) or with Cross Grain Top (BSOBC)
  - 2 solid doors, Straight (BSCT) or with Cross (BSDC) Grain Top
  - 2 file drawers, Straight (BSLFT) or with Cross (BSLFC) Grain Top
  - 2 file boxes and 1 file drawer, Straight (BSBT) or with Cross (BSPC) Grain Top
- Depths : 20", 24", 27"
- Widths : 24" to 36" in 6" increments
- Height: 29" from the floor to the top of finished worksurface with a leveling range of 1"
- Top are available in the same styles/thicknesses (1 3/16" (M) or 1 9/16" (X)) as worksurfaces
- Four finish configurations are available:
  - All Laminate (L)
  - Wood Top; Laminate Front and Case (T)
  - Wood Top and Front; Laminate Case (U)
  - All Wood (W)
- A Wall Panel can be mounted on these storage, refer to page 270, for more details
- Constructed without toe kick

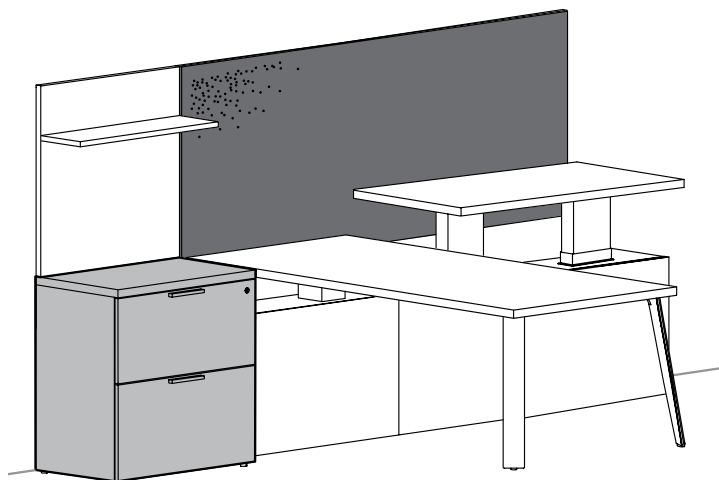

Workwall Lateral Files – Integral Top – 29" h (BSLFT) (Shown)

- Additional shelves **cannot** be specified separately
- Can store two rows of standard letter-size binders
- Have holes in 1 1/4" intervals on the inside walls for shelf height adjustment

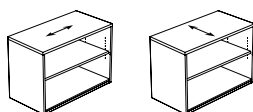

## Workwall Bookcase – Integral Top – 29" h (BSOBT) or Workwall Bookcase – Integral Top – 29" h – Cross Grain (BSOBC)

- Comes with 1 adjustable shelf
- Bookcase depth is designed to align with the case of the other storage units with front

TOP VIEW

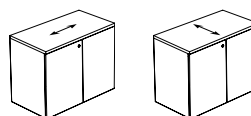
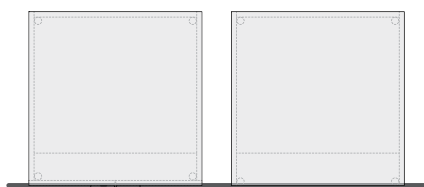

## Workwall Storage Cabinet – Integral Top – 29" h (BSCT) or Workwall Bookcase – Integral Top – 29" h – Cross Grain (BSDC)

Two Storage Styles are available:

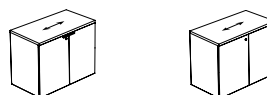

Pulls (P)

Touch-to-Open (T)

- Comes with 1 adjustable shelf
- Door fronts are flushed with front edge of the top

## workwall storage – integral top – 29" h – basics (continued)

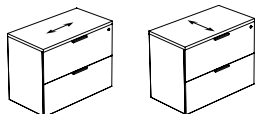

### Workwall Lateral File – Integral Top – 29" h (BSLFT) or Workwall Lateral File – Integral Top – 29" h – Cross Grain (BSLFC)

- Comes with two file drawers
- Come with a central locking system and full extension drawers that can accommodate both letter- and legal-size paper
- Equipped with an interlock system that prevents opening more than one drawer at a time
- Drawer fronts edge is flushed with front of the top
- Counterweights are included with this storage
- File drawers include 15" Cross File Bars

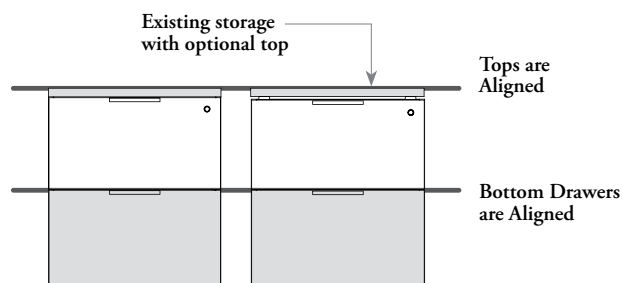

### Storage Drawer Datum Line

Only the worksurface top and bottom drawers datum line are aligned with existing laminate storage and optional top when positioned side-by-side

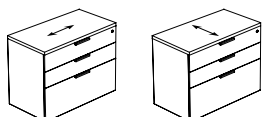

### Workwall Stretch Pedestal – Integral Top – 29" h (BSPT) or Workwall Stretch Pedestal – Integral Top – 29" h – Cross Grain (BSPC)

- Comes with two box drawers and one file drawer
- Come with a central locking system and full extension drawers that can accommodate both letter- and legal-size paper
- Equipped with an interlock system that prevents opening more than one drawer at a time
- Drawer fronts edge is flushed with front of the top
- Counterweights are included with this storage
- Include Anodized Pencil Tray in one box file drawer et one 15" Cross File Bars in the file drawer

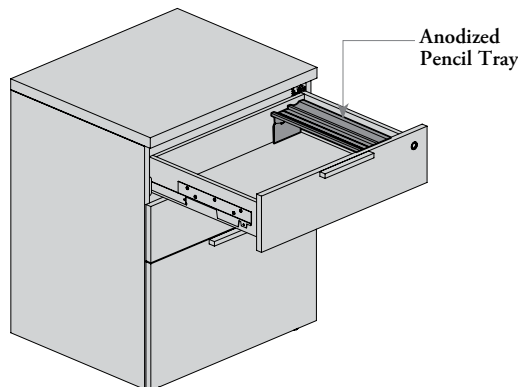

# workwall cabinet & stretch pedestal – mid – 21" h – basics

- Door or drawers come with Rectilinear Pull (9) only
- Back is partially open to provide wall access (electricity management)
- **Cannot** support one end of a semi-supported worksurface

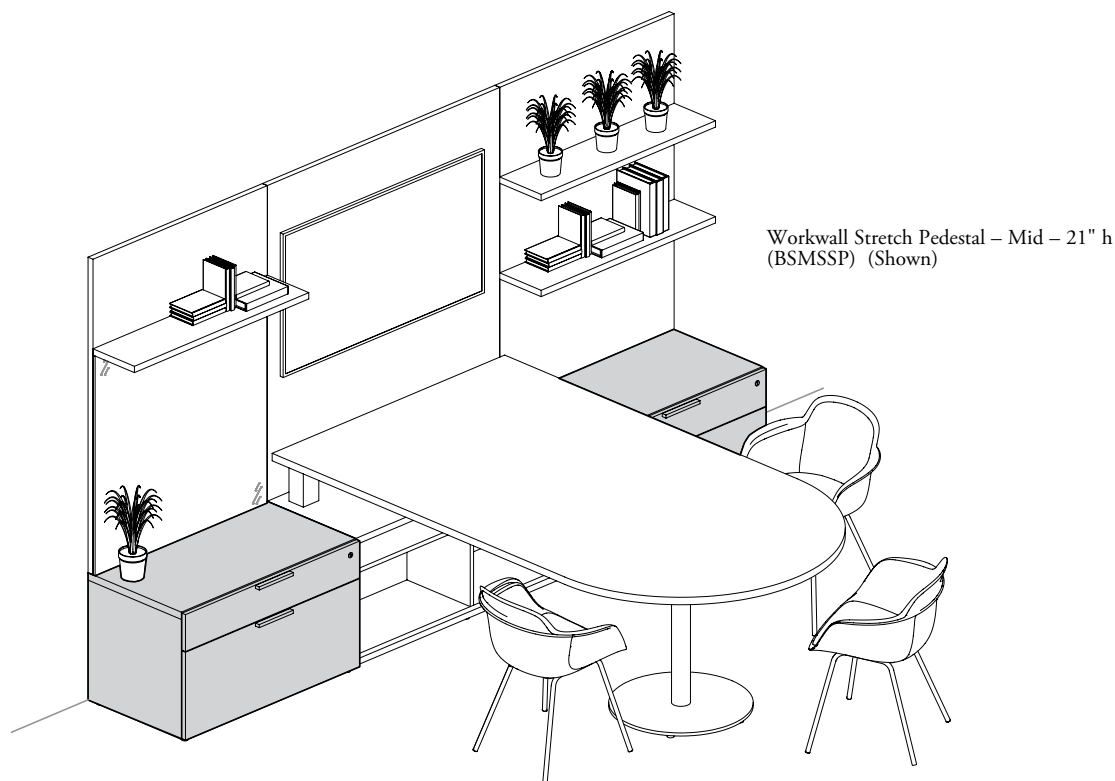

Workwall Stretch Pedestal – Mid – 21" h (BSMSSP) (Shown)

- The mid-height Workwall Cabinet (BSMD) or Workwall Stretch Pedestal (BSMSSP) provide against the wall storage for the office or meeting room
- Can support Wall Panels (B\_WCC, B\_WCO, B\_WAA, B\_WOO, B\_WMD, B\_WMO or B\_WMM)
- Available in 21" high from floor to top of finished worksurface with leveling range of 1"
- Storage is non handed

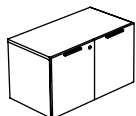

### Workwall Cabinet – Mid – 21" h (BSMD)

- Available in depths: 20" or 24"
- Available in widths: 24" to 36" (6" increments)
- Comes with one adjustable shelf
- Have holes in 1 1/4" intervals on the inside walls for shelf height adjustment
- Additional shelves **cannot** be specified separately
- **Cannot** be stored two rows of standard letter-size binders
- Can be used freestanding, **no** wall anchoring is needed

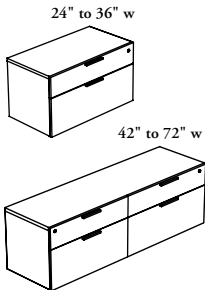

### Workwall Stretch Pedestal – Mid – 21" h (BSMSSP)

- Comes with box and file drawers
- Available in depths: 20" or 24"
- Available in widths: 24" to 72" (6" increments)
- Come full extension drawers that can accommodate both letter- and legal-size paper
- Must be wall anchored

## workwall cabinet – mid – 21" h – interior clearance

The following outline the interior clearance available for all mid-height Workwall Cabinet (BSMD).

### interior clearance height

- The open section features holes at 1 1/4" intervals on the interior walls, allowing for convenient adjustment of shelf height
- The following height dimension listed below are available for all mid-height Workwall Cabinet

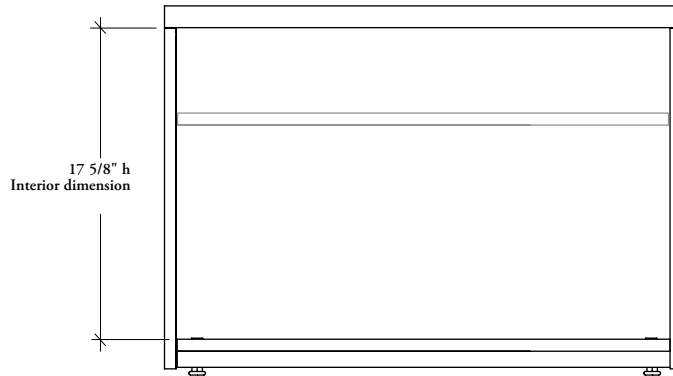

### interior clearance depth (20" deep shown)

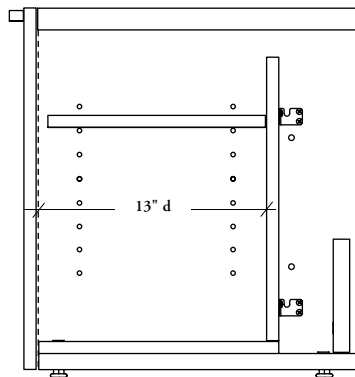

# understanding workwall credenzas – mid – 21" h

All dimensions in this section are nominal

## workwall credenzas – mid – 21" h

- Two styles can be specified:
  - **Standard:**  
21" high Workwall Credenzas (BSMCD, BSMOD or BSMDOD)
  - **Supporting:**  
Fixed or Height-Adjustable Worksurfaces – Mid – 21" h (BSMWL, BSMHLR, BSMHDP, BSMCFW, BSMCHR or BSMHCP)  
Height-Adjustable Worksurface – Mid – 21" h (BSMHLR or BSMCHR)
- Can support Wall Panels (B\_WCC\*, B\_WCO\*, B\_WAA, B\_WOO, B\_WMD, B\_WMO or B\_WMM)
- Two worksurface positions are available:
  - Left (L)
  - Right (R)
- For more details on mid-height Workwall Credenza Applications, refer to page 388

### standard style

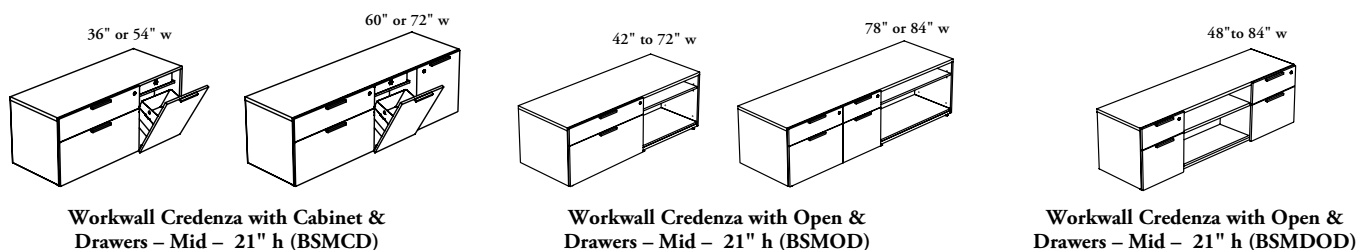

### supporting style

For more details on this product listed below, refer to Multi-Level Workstations & Meeting Tables Sections

#### Workwall Credenza with Open & Drawers – Fixed Worksurface – Mid – 21" h (BSMWL)

Only products illustrated below can be installed on this credenza:

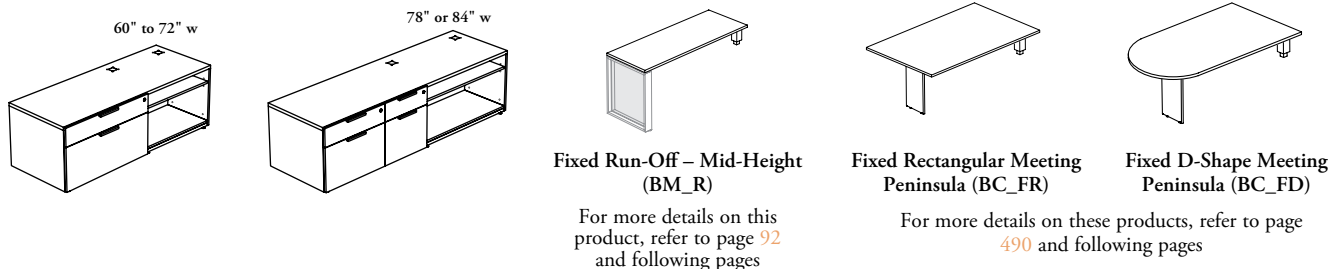

#### Workwall Credenza with Open & Combo – Fixed Worksurface – Mid – 21" h (BSMCFW)

Only products illustrated below can be installed on this module:

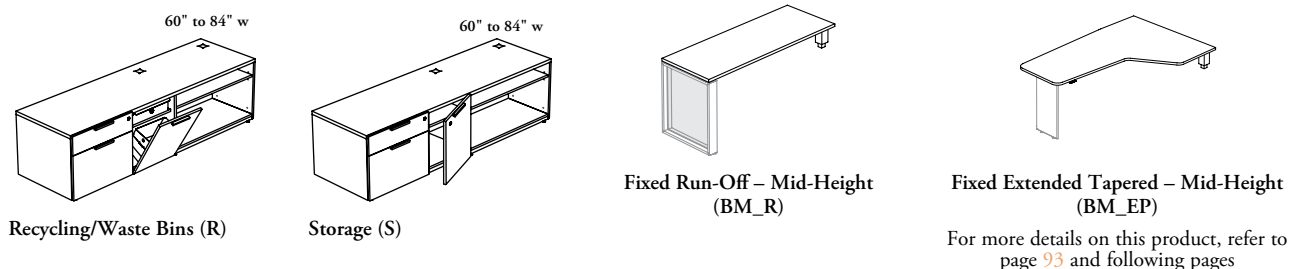

# understanding workwall credenzas – mid – 21" h (continued)

## supporting style

For more details on these products listed below, refer to Multi-Level Workstations Section

### Workwall Credenza with Open & Drawers – Height-Adjustable Run-Off – Mid – 21" h (BSMHLR)

Only products illustrated below can be installed on this credenza:

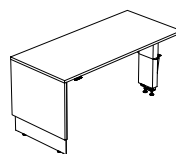
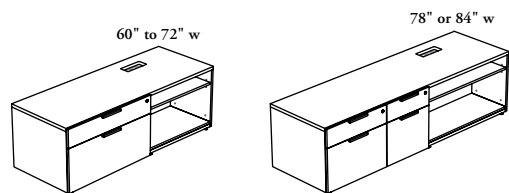

Height-Adjustable  
Run-Off  
(BH\_RB)

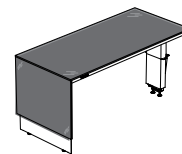

Height-Adjustable  
Run-Off with Glass Top  
(BHGRB)

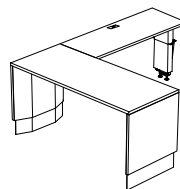

Height-Adjustable  
Desk for U-Shape  
Workstation  
(BH\_UB)

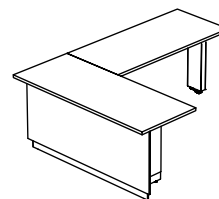

Full-Modesty Height-  
Adjustable Desk  
for U-Shape Workstation  
(BF\_U)

### Workwall Credenza with Open & Drawers – Height-Adjustable Peninsula – Mid – 21" h (BSMHDP)

Only products illustrated below can be installed on this credenza:

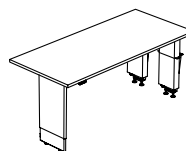
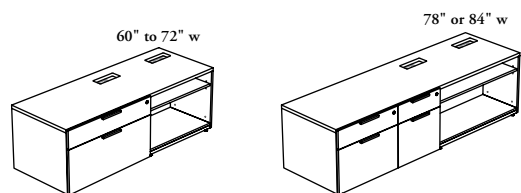

Height-Adjustable  
Peninsula  
(BH\_RP)

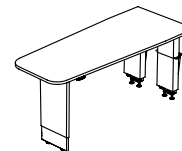

Height-Adjustable  
Tapered Peninsula  
(BH\_TP)



# understanding workwall credenzas – mid – 21" h (continued)

## supporting style (continued)

For more details on these products listed below, refer to Multi-Level Workstations Section

### Workwall Credenza with Open & Combo – Height-Adjustable Run-Off – Mid – 21" h (BSMCHR)

Only products illustrated below can be installed on this credenza:

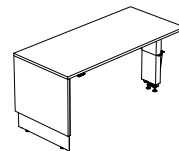
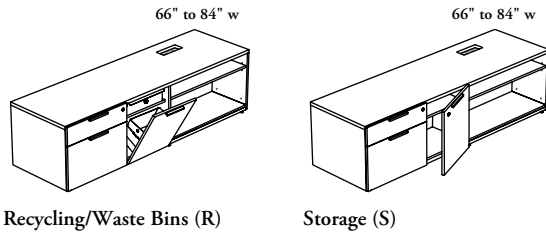

Height-Adjustable Run-Off (BH\_RB)

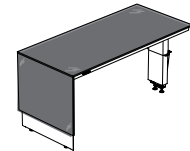

Height-Adjustable Run-Off with Glass Top (BHGRB)

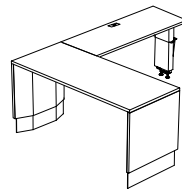

Height-Adjustable Desk for U-Shape Workstation (BH\_UB)

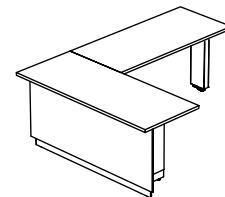

Full-Modesty Height-Adjustable Desk for U-Shape Workstation (BF\_U)

### Workwall Credenza with Open & Combo – Height-Adjustable Peninsula – Mid – 21" h (BSMHCP)

Only products illustrated below can be installed on this credenza:

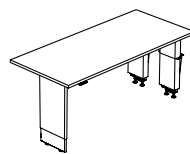
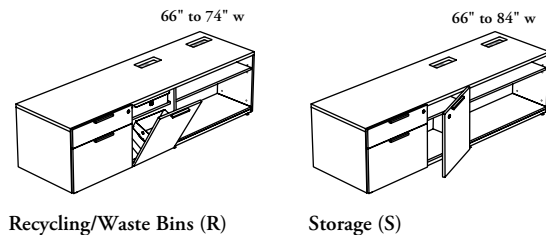

Height-Adjustable Peninsula (BH\_RP)

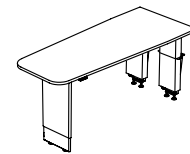

Height-Adjustable Tapered Peninsula (BH\_TP)

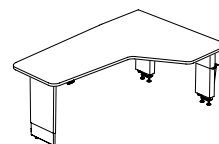

Height-Adjustable Extended Tapered Peninsula (BH\_PE)

# workwall credenza – mid – 21" h – components

The following should be considered when planning with Expansion Casegoods mid-height Workwall Credenzas for Height-Adjustability or Fixed Worksurfaces.

components & cable routing on standard or fixed worksurface supporting style (shown)

BACK VIEW

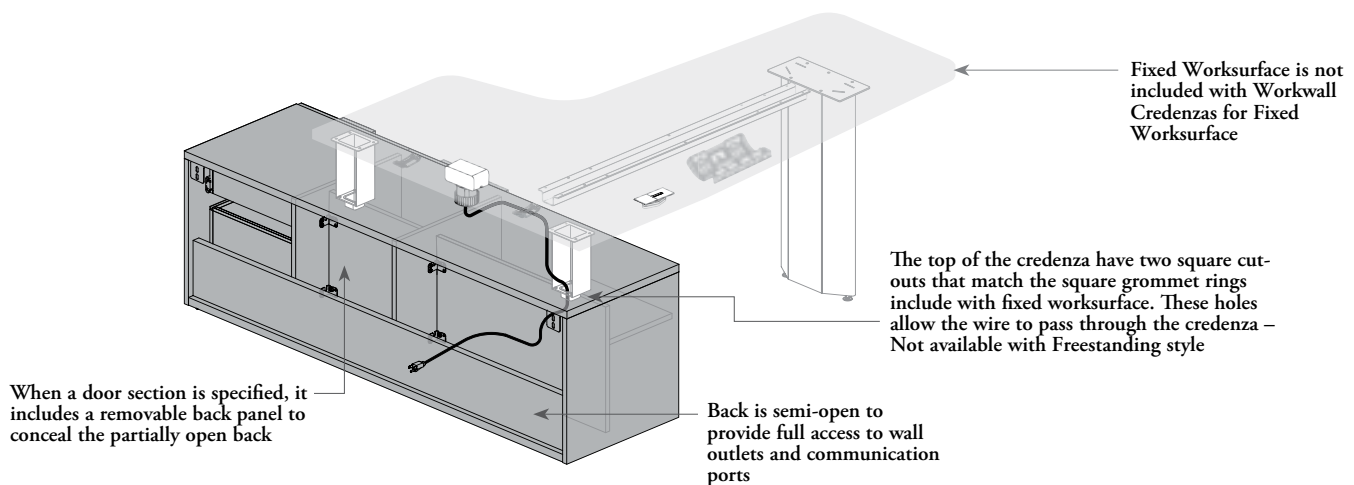

components & cable routing on standard or height-adjustable worksurface supporting style

BACK VIEW

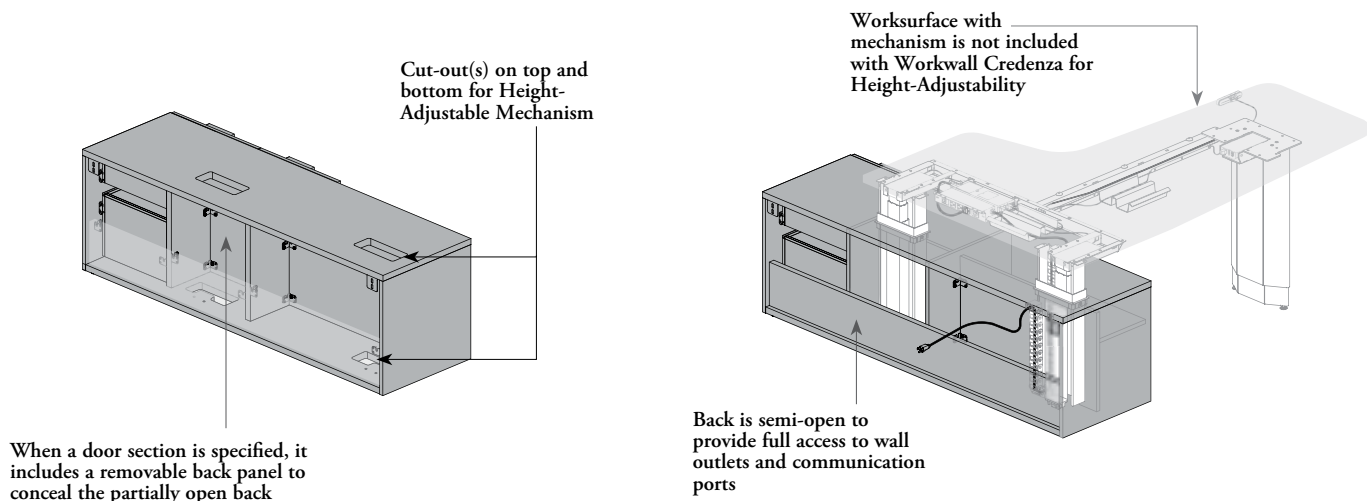

# workwall credenza – mid – 21" h – components (continued)

## door configurations on workwall credenzas with cabinet section configuration

- Come with 18" central door front nominal width
- Come with Rectilinear Pulls (9) only
- Four Workwall Credenzas for Fixed or Height-Adjustability styles:
  - Workwall Credenza with Cabinet and Drawers – Mid – 21" h (BSMCD)
  - Workwall Credenza with Open Combo – Fixed Worksurface – Mid – 21" h (BSMCFW)
  - Workwall Credenza with Open Combo – Height-Adjustable Run-Off – Mid – 21" h (BSMCHR)
  - Workwall Credenza with Open Combo – Height-Adjustable Peninsula – Mid – 21" h (BSMHCP)
- Two Door Configurations are available:

### Recycling and Waste Bins (R)

- Provides closed recycling and/or waste bin storage
- Storage Bins are removable
- Comes with one flip-down door
- This section is **not** lockable

### Recycling and Waste Bins Anatomy

Waste bin require a 20" wide x 12" high bag (**13 Liter Capacity**) for a true fit. Waste bin include side detail to manage the excess of bag

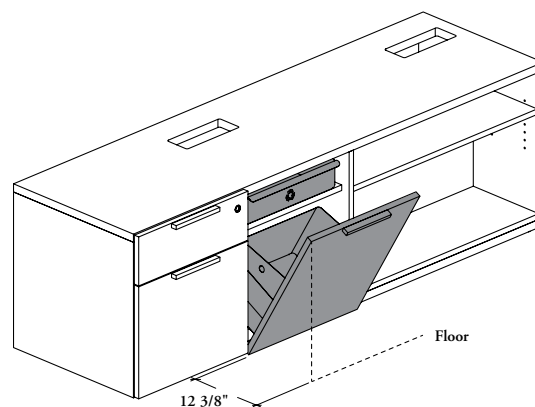
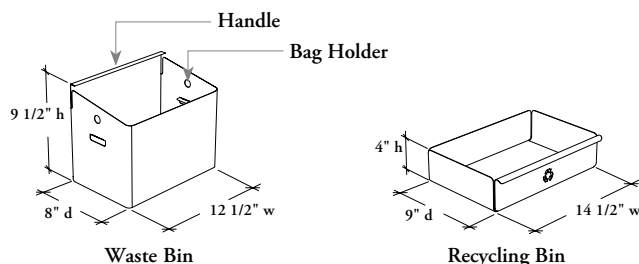

### Storage (S)

- Provides closed and lockable storage with one adjustable shelf
- Comes with one adjustable shelf and has holes in 1 1/4" intervals on the inside walls for shelf height adjustment

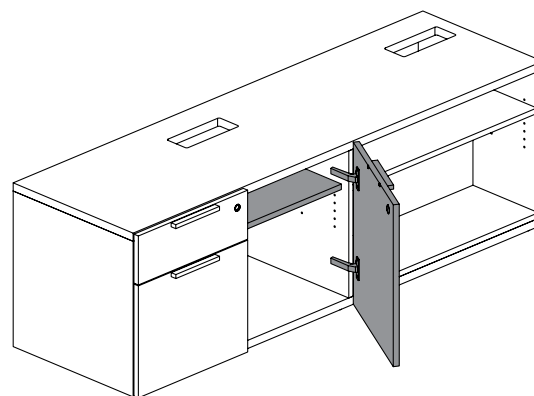

## workwall credenza – mid – 21" h – basics

Expansion Casegoods Workwall Credenzas can be used alone or with a selection of Fixed or Height-Adjustable Worksurfaces.

- ❗ When using a Workwall Credenza (BSMCD, BSMOD, BSMWL, BSMHLR, BSMDOD and BSMCHR), wall anchored is recommended for optimal stiffness but is **not** mandatory
- When using a Workwall Credenza (BSMHDP, BSMCFW and BSMHCP), no wall anchoring is needed
- Door or drawers come with Rectilinear Pull (9) only
- Cannot** be installed under a desk
- Back is partially open to provide wall access (electricity management)
- A Seat Pad/Cushion can be installed on these credenzas

- Provides storage against the wall and support for one end Fixed or Height-Adjustable Worksurfaces
- Height: 21"
- Depths: 20" or 24"
- Include levelers with an adjustment range of 1"
- Lock option is standard lock
- If applicable, open section with adjustable shelf configurations has holes in 1 1/4" intervals on the inside walls for shelf height adjustment
- Additional shelves **cannot** be specified for these products
- A Wall Panel is **not** mandatory for mounting fixed or Height-Adjustable Worksurface
- The bottom drawer of the Storage are aligned with the bottom drawer off all filing storage of the Freestanding Storage section, except the metal one, when placed side-by-side

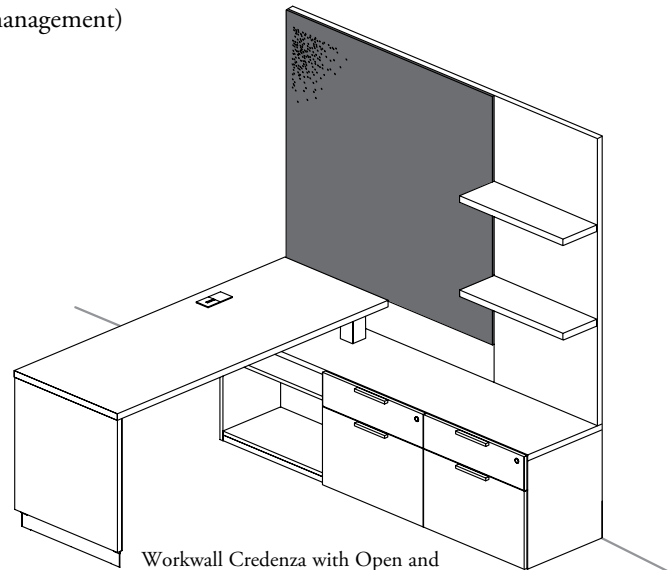

Workwall Credenza with Open and Drawers – Fixed Worksurface – Mid – 21" h (BSMWL) (Shown)

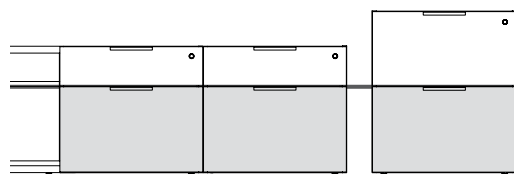

Bottom Drawers are aligned

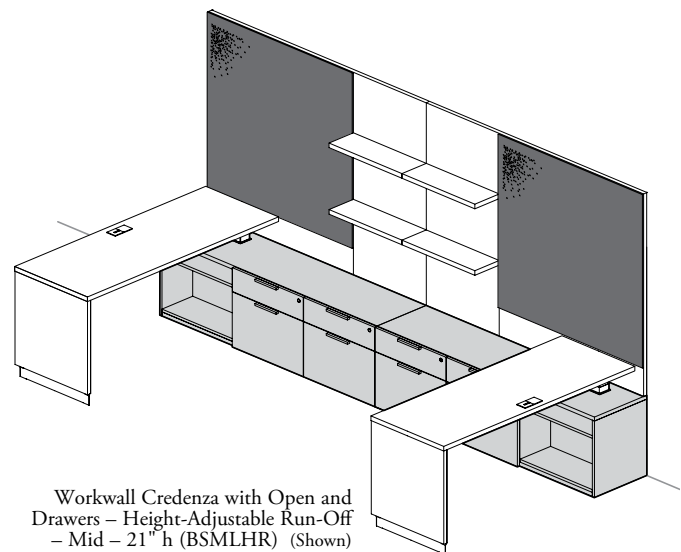

Workwall Credenza with Open and Drawers – Height-Adjustable Run-Off – Mid – 21" h (BSMLHR) (Shown)

# workwall credenza – mid – 21" h – basics (continued)

36" to 54" w

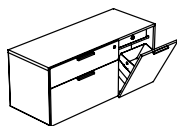

Include Recycling/  
Waste Bins

60" to 72" w

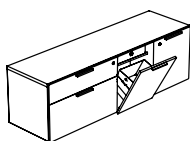

Include Recycling/Waste  
Bins + Storage

## Workwall Credenza with Cabinet and Drawers – Mid – 21" h (BSMCD)

- Cannot support one end of a semi-supported worksurface
- Widths: 36" to 72" (6" increments)
- When 60" wide and more is specified, an additional door section appears, opposite side to drawer's section
- Features full-extension drawers capable of accommodating both letter- and legal-size paper
- Drawer Configurations:
  - Drawers on Left (L) (Shown)
  - Drawer on Right (R)

42" to 72" w

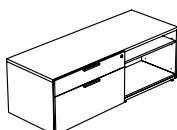

78" or 84" w

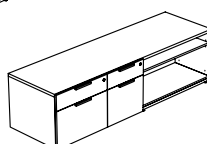

## Workwall Credenza with Open and Drawers – Mid – 21" h (BSMOD)

- Cannot support one end of a semi-supported worksurface
- Widths: 42" to 84" (6" increments)
- Features full-extension drawers capable of accommodating both letter- and legal-size paper
- Drawer Configurations:
  - Drawers on Left (L) (Shown)
  - Drawer on Right (R)

60" to 72" w

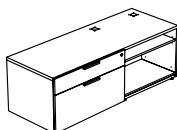

78" or 84" w

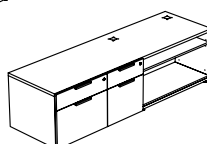

## Workwall Credenza with Open and Drawers – Fixed Worksurface – Mid 21" h (BSMWL)

- Widths: 60" to 84" (6" increments)
- Fixed Worksurface Depths: 30" or 36"
- Worksurface Positions:
  - Left (L)
  - Right (R) (Shown)
- Features full-extension drawers capable of accommodating both letter- and legal-size paper
- Must be used with:
  - Fixed Run-Off – Mid-Height (BM\_R)
  - Fixed Rectangular Meeting Peninsula (BC\_FR)
  - Fixed D-Shape Meeting Peninsula (BC\_FD)

60" to 72" w

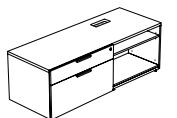

72" to 84" w

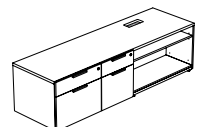

## Workwall Credenza with Open and Drawers – Height-Adjustable Run-Off – Mid – 21" h (BSMHRL)

- Widths: 60" to 84" (6" increments)
- Height-Adjustable Worksurface Depths: 23", 29" or 35"
- Worksurface Positions:
  - Left (L)
  - Right (R) (Shown)
- Features full-extension drawers capable of accommodating both letter- and legal-size paper
- Must be used with:
  - Full-Modesty Height-Adjustable Desk for U-Shape Workstation – Offset Bases (BF\_U)
  - Height-Adjustable Run-Off – Bevel Base (BH\_RB)
  - Height-Adjustable Run-Off with Glass Top – Bevel Base (BHGRB)
  - Height-Adjustable Desk for U-Shape Workstation – Bevel Bases
  - Mid-Height (BH\_UBK)

60" to 72" w

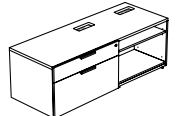

78" or 84" w

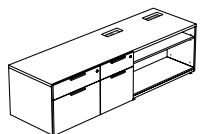

## Workwall Credenza with Open and Drawers – Height-Adjustable Peninsula – Mid – 21" h (BSMHDP)

- Widths: 60" to 84" (6" increments)
- Height-Adjustable Worksurface Depth: 35"
- Worksurface Positions:
  - Left (L)
  - Right (R) (Shown)
- Features full-extension drawers capable of accommodating both letter- and legal-size paper
- Must be used with:
  - Height-Adjustable Peninsula – Bevel Post Leg (BH\_RP or BH\_TP)

## workwall credenza – mid – 21" h – basics (continued)

48" to 84" w

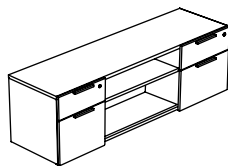

### Workwall Credenza for Media with Open and Drawers – Mid – 21" h (BSMDOD)

- Cannot support one end of a semi-supported worksurface
- Widths: 42" to 84" (6" increments)
- Features full-extension drawers capable of accommodating both letter- and legal-size paper

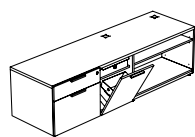

Recycling/Waste Bins (R)

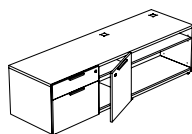

Storage (S)

### Workwall Credenza with Open and Combo – Fixed Worksurface – Mid 21" h (BSMCFW)

- Widths: 66" to 84" (6" increments)
- Fixed Worksurface Depth: 30" to 54" (6" increments)
- Worksurface Positions:
  - Left (L)
  - Right (R) (Shown)
- Door Configurations:
  - Recycling/Waste Bins (R)
  - Storage (S)
- Features full-extension drawers capable of accommodating both letter- and legal-size paper
- Must be used with:
  - Fixed Run-Off – Bevel Base (BM\_R)
  - Fixed Extended Tapered Peninsula – Bevel Post Leg (BM\_EP)

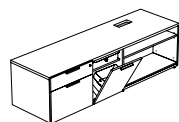

Recycling/Waste Bins (R)

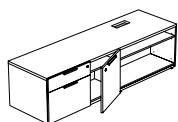

Storage (S)

### Workwall Credenza with Open and Combo – Height-Adjustable Run-Off – Mid – 21" h (BSMCHR)

- Widths: 66" to 84" (6" increments)
- Height-Adjustable Worksurface Depths: 23", 29", 35"
- Worksurface Positions:
  - Left (L)
  - Right (R) (Shown)
- Door Configurations:
  - Recycling/Waste Bins (R)
  - Storage (S)
- Features full-extension drawers capable of accommodating both letter- and legal-size paper
- Must be used with:
  - Full-Modesty Height-Adjustable Desk for U-Shape Workstation – Offset Bases (BF\_U)
  - Height-Adjustable Run-Off – Bevel Base (BH\_RB)
  - Height-Adjustable Run-Off with Glass Top – Bevel Base (BHGRB)
  - Height-Adjustable Desk for U-Shape Workstation – Bevel Bases
    - Mid-Height (BH\_UBK)

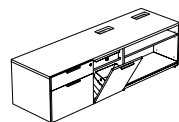

Recycling/Waste Bins (R)

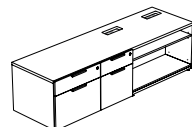

Storage (S)

### Workwall Credenza with Open and Combo – Height-Adjustable Peninsula – Mid – 21" h (BSMHCP)

- Widths: 66" to 84" (6" increments)
- Height-Adjustable Worksurface Depth: 35", 46" or 52"
- Worksurface Positions:
  - Left (L)
  - Right (R) (Shown)
- Door Configurations:
  - Recycling/Waste Bins (R)
  - Storage (S)
- Features full-extension drawers capable of accommodating both letter- and legal-size paper
- Must be used with:
  - Height-Adjustable Peninsula – Bevel Post Leg (BH\_RP, BH\_TP or BH\_PE)

# workwall credenzas for fixed or height-adjustable worksurfaces – drawer widths

The following illustrates Expansion Casegoods mid-height Workwall Credenzas drawer and open sections nominal widths.

## workwall credenza with cabinet & drawers – mid – 21" h (BSMCD)

Only Drawers on Left (L) is shown

- Comes with one Box & File Drawers Section
- Includes one Recycling/Waste Bins Section

36" Width

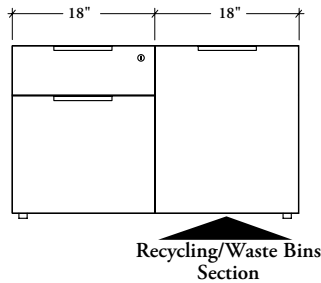

42" Width

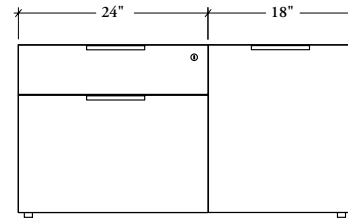

48" Width

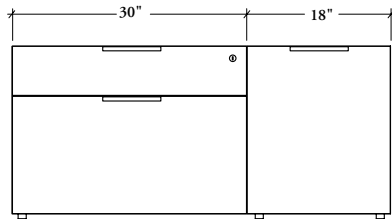

54" Width

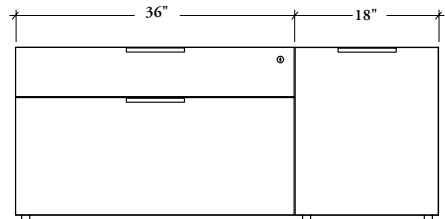

60" Width

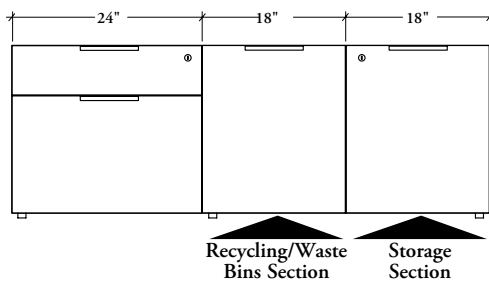

66" Width

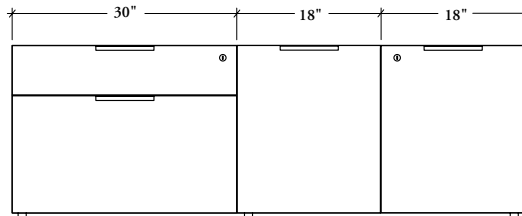

- Comes one Box & File Drawers Section
- Includes one Recycling/Waste Bins and one Storage Sections

72" Width

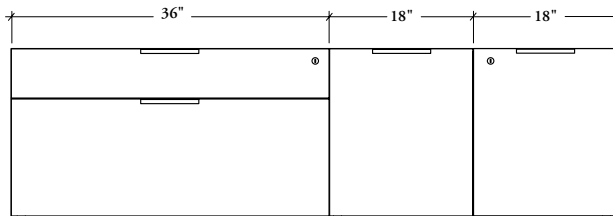

# workwall credenzas for fixed or height-adjustable worksurfaces – drawer widths (continued)

## workwall credenza with open & drawers – mid – 21" h (BSMOD)

Only Drawers on Left (L) is showed

- Comes with one Box & File Drawers Section
- Includes one Open Section

42" Width

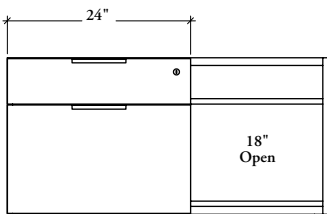

48" Width

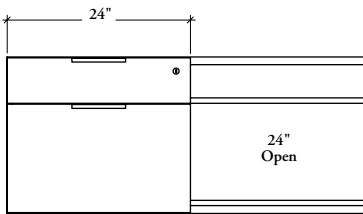

54" Width

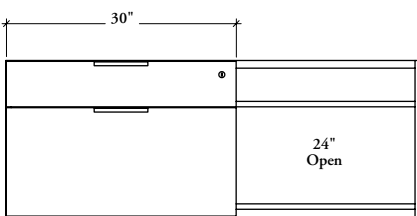

60" Width

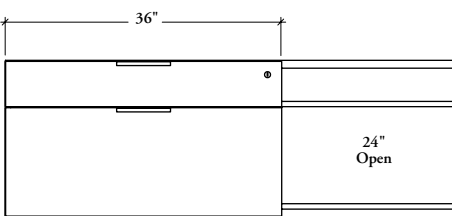

66" Width

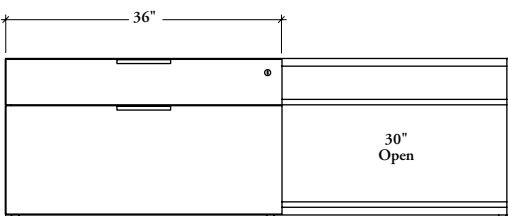

72" Width

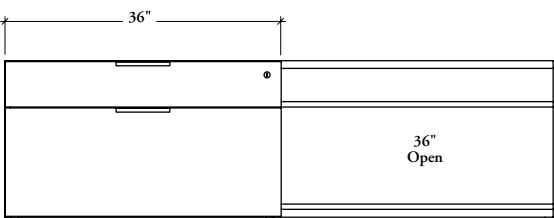

78" Width

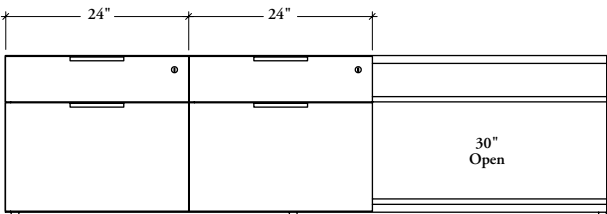

- Comes two Box & File Drawers Section
- Includes one Open Section

84" Width

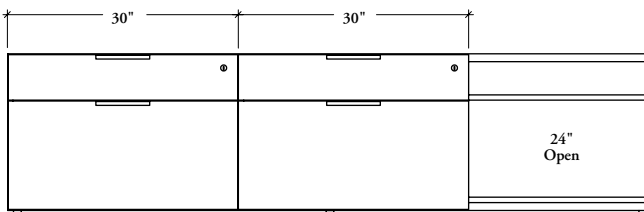



# workwall credenzas for fixed or height-adjustable worksurfaces – drawer widths (continued)

workwall credenza for media with open & drawers – mid – 21" h (BSMDOD)

48" Width

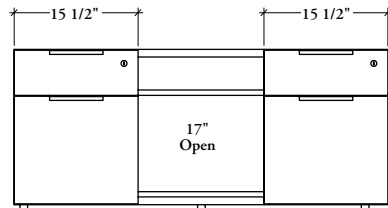

54" Width

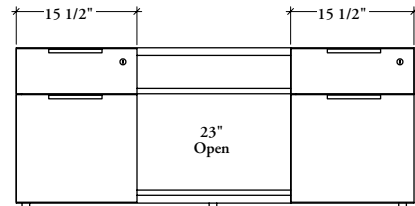

60" Width

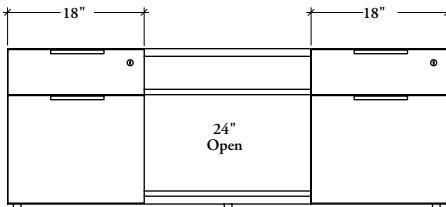

66" Width

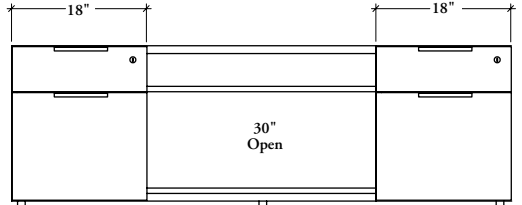

72" Width

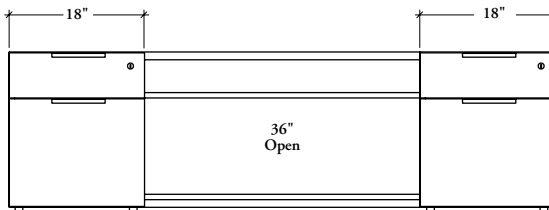

78" Width

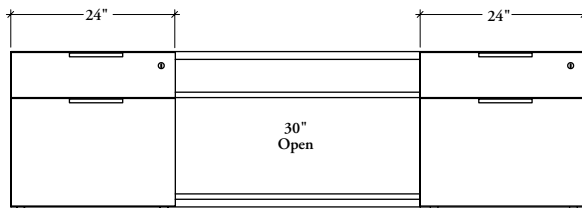

84" Width

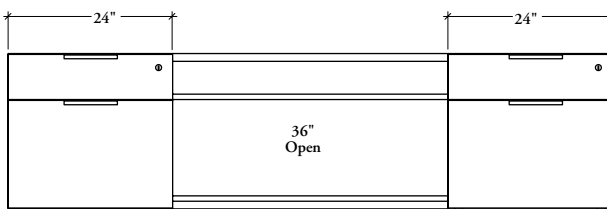

- Comes with Box & File Drawers on both ends
- Includes one Open Central Section

# workwall credenzas for fixed or height-adjustable worksurfaces – drawer widths (continued)

workwall credenza with with open & drawers – height-adjustable run-off– mid – 21" h (BSMHLR)

Only Drawers on Left (L) is shown

for 23" deep Height-Adjustable Desk  
for U-Shape or Full-Modesty Height-Adjustable Desk for U-Shape

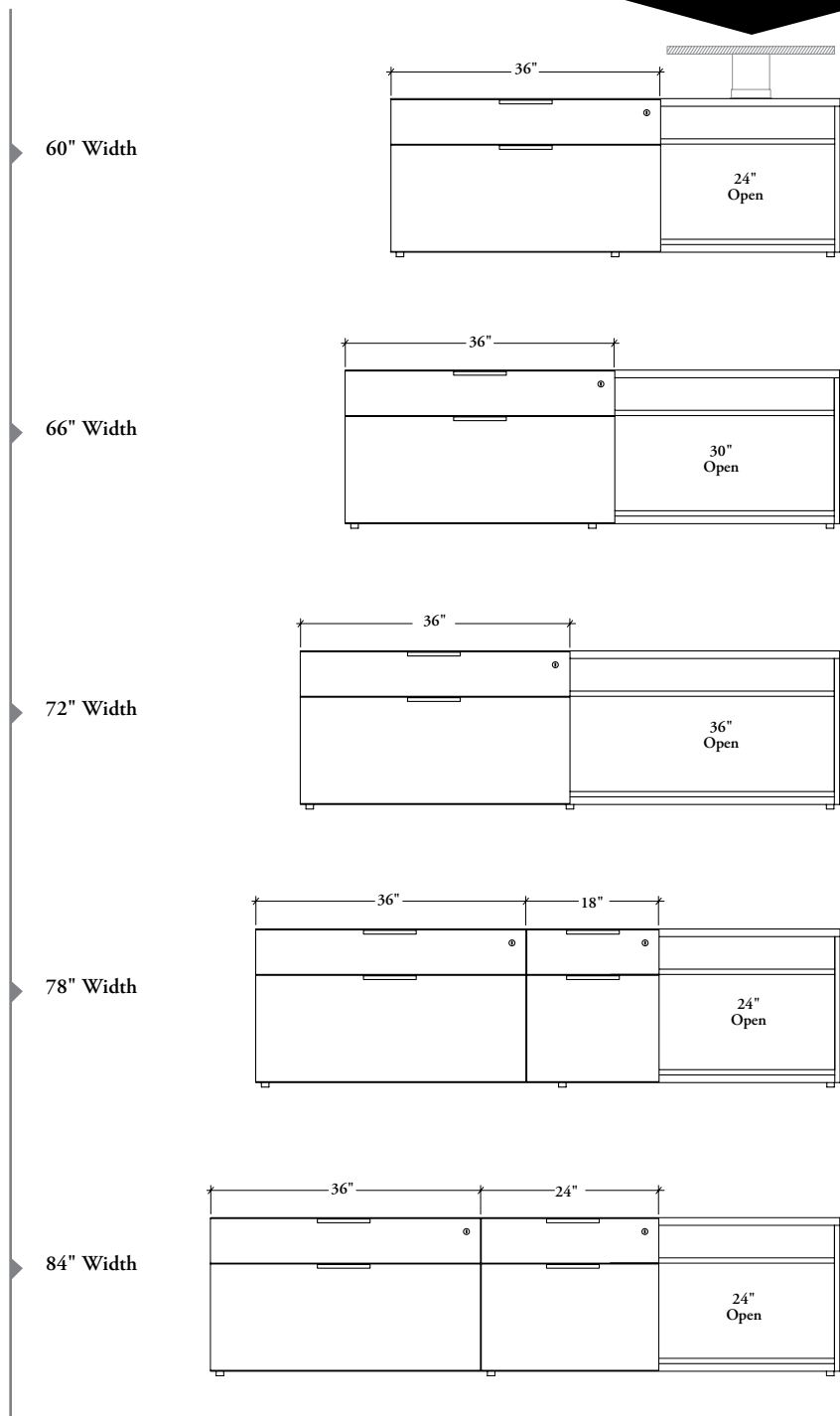

# workwall credenzas for fixed or height-adjustable worksurfaces – drawer widths (continued)

workwall credenza with with open & combo – height-adjustable run-off– mid – 21" h (BSMCHR)

Only Drawers on Left (L) is shown

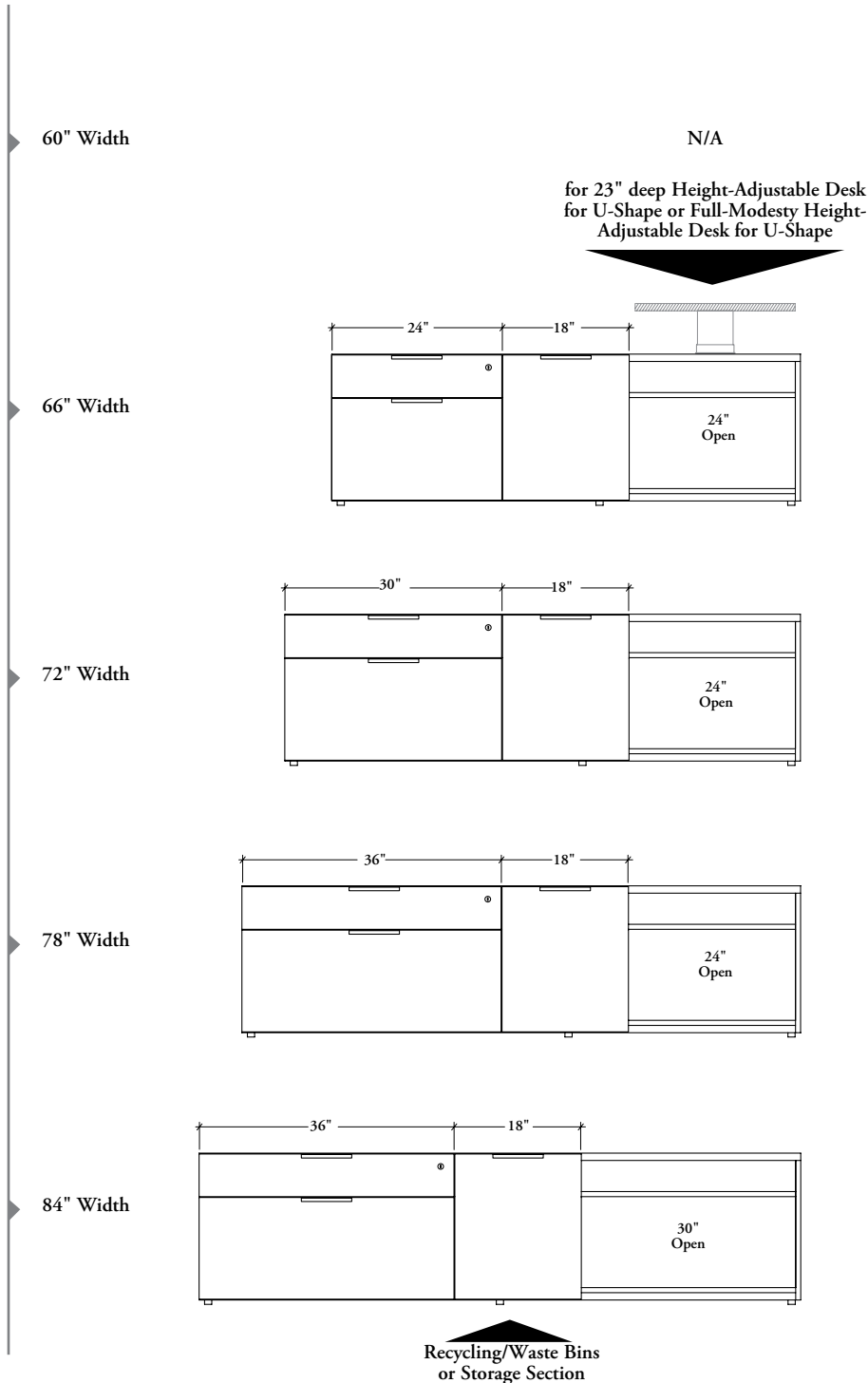

# workwall credenzas for fixed or height-adjustable worksurfaces – drawer widths (continued)

workwall credenza with with open & drawers – fixed worksurface – mid – 21" h (BSMWL) or  
workwall credenza with with open & drawers – height-adjustable run-off– mid – 21" h (BSMHLR)

Only Drawers on Left (L) is shown

for 30" deep Fixed Run-Off or for  
29" deep Height-Adjustable Run-Off/  
Desk for U-Shape or Full-Modesty  
Height-Adjustable Desk for U-Shape

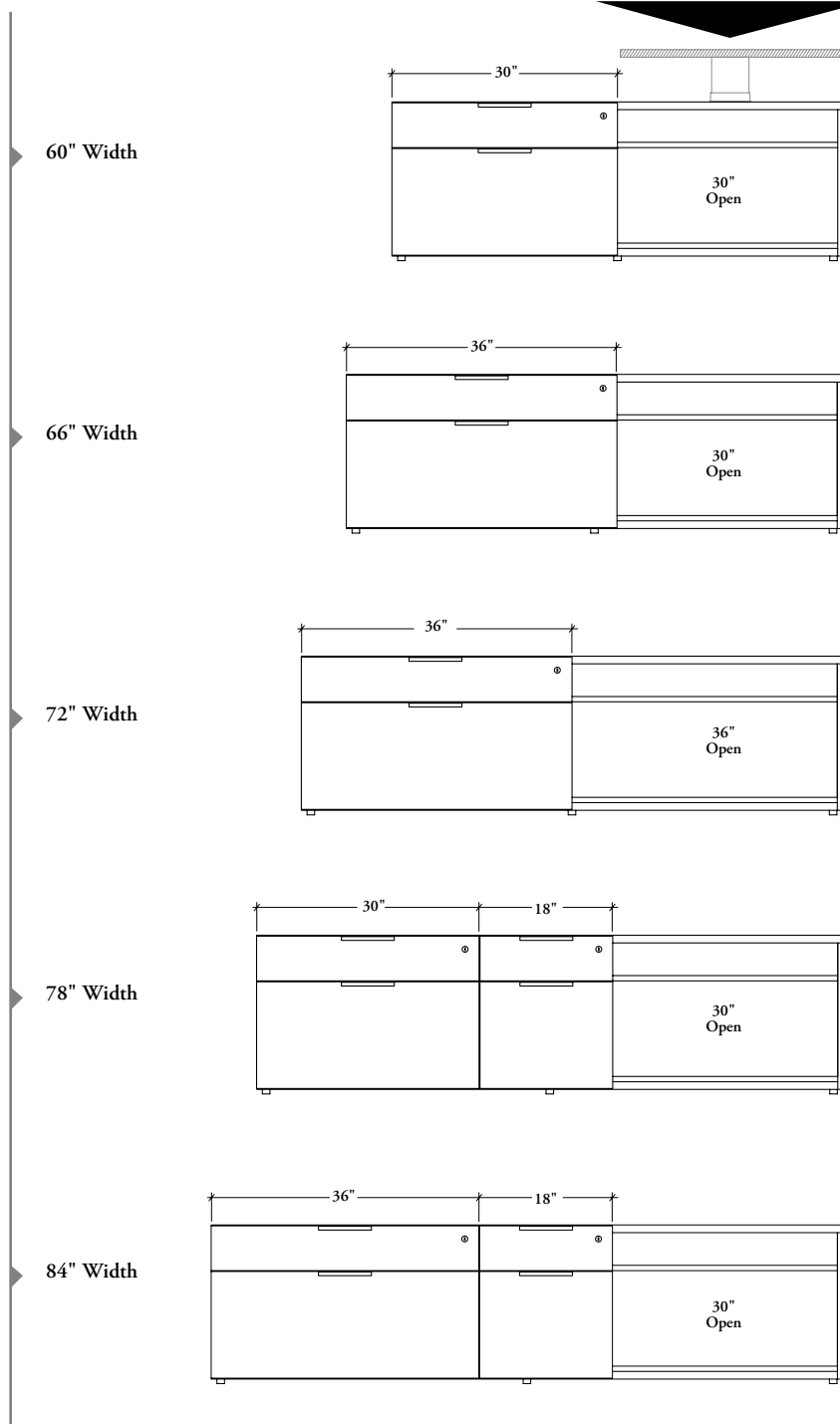

# workwall credenzas for fixed or height-adjustable worksurfaces – drawer widths (continued)

workwall credenza with with open & drawers – fixed worksurface mid – 21" h (BSMWL) or  
 workwall credenza with with open & drawers – height-adjustable run-off – mid – 21" h (BSMHLR)  
 workwall credenza with with open & drawers – height-adjustable peninsula – mid – 21" h (BSMHDP)

Only Drawers on Left (L) is showned

for 36" deep Fixed Run-Off or  
 for 35" deep Height-Adjustable Run-Off or  
 Height-Adjustable Rect. or Tap. Peninsulas

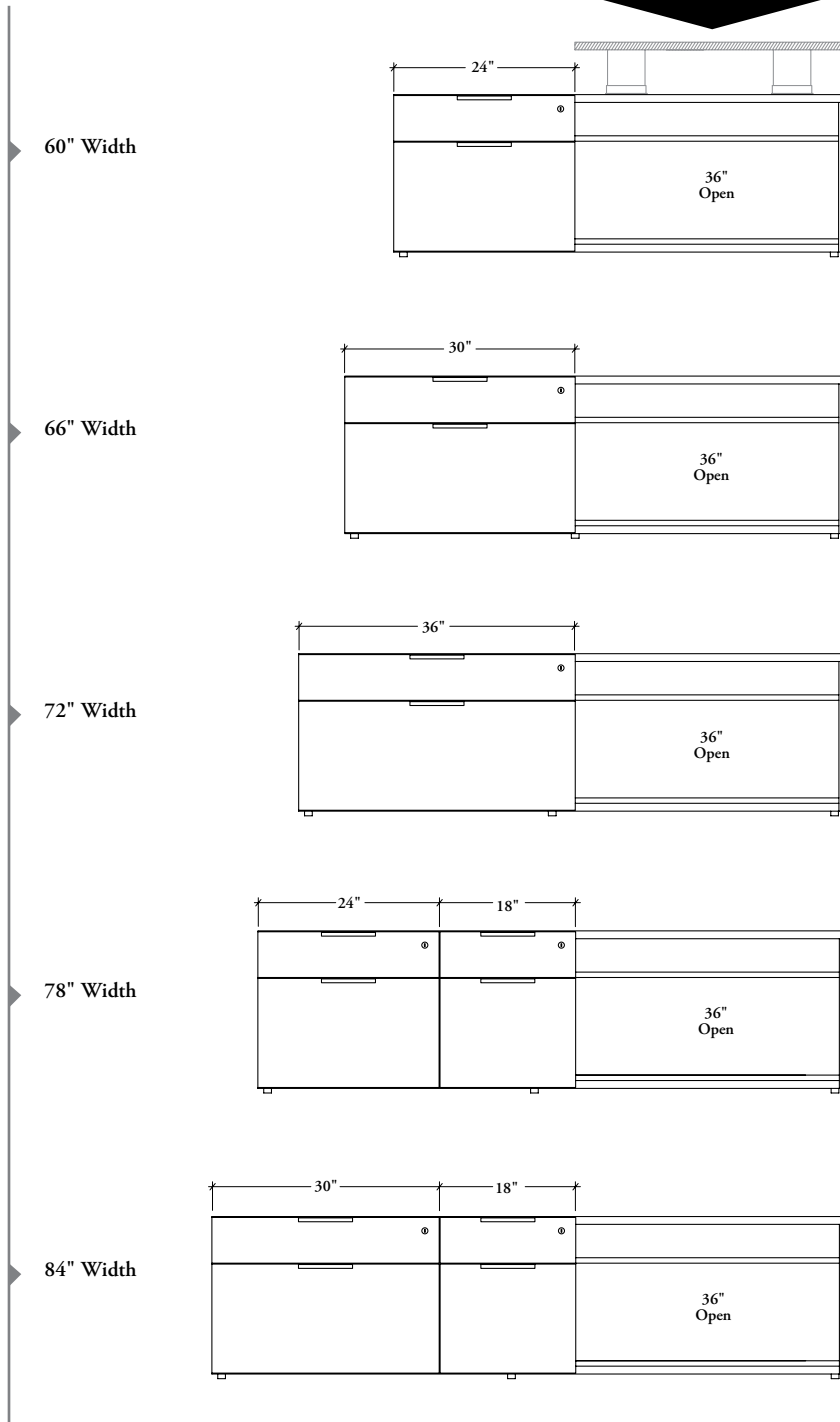

# workwall credenzas for fixed or height-adjustable worksurfaces – drawer widths (continued)

workwall credenza with with open & combo – fixed-worksurface – mid – 21" h (BSMCFW) or  
 workwall credenza with with open & combo – height-adjustable run-off – mid – 21" h (BSMCHR)

Only Drawers on Left (L) is shown

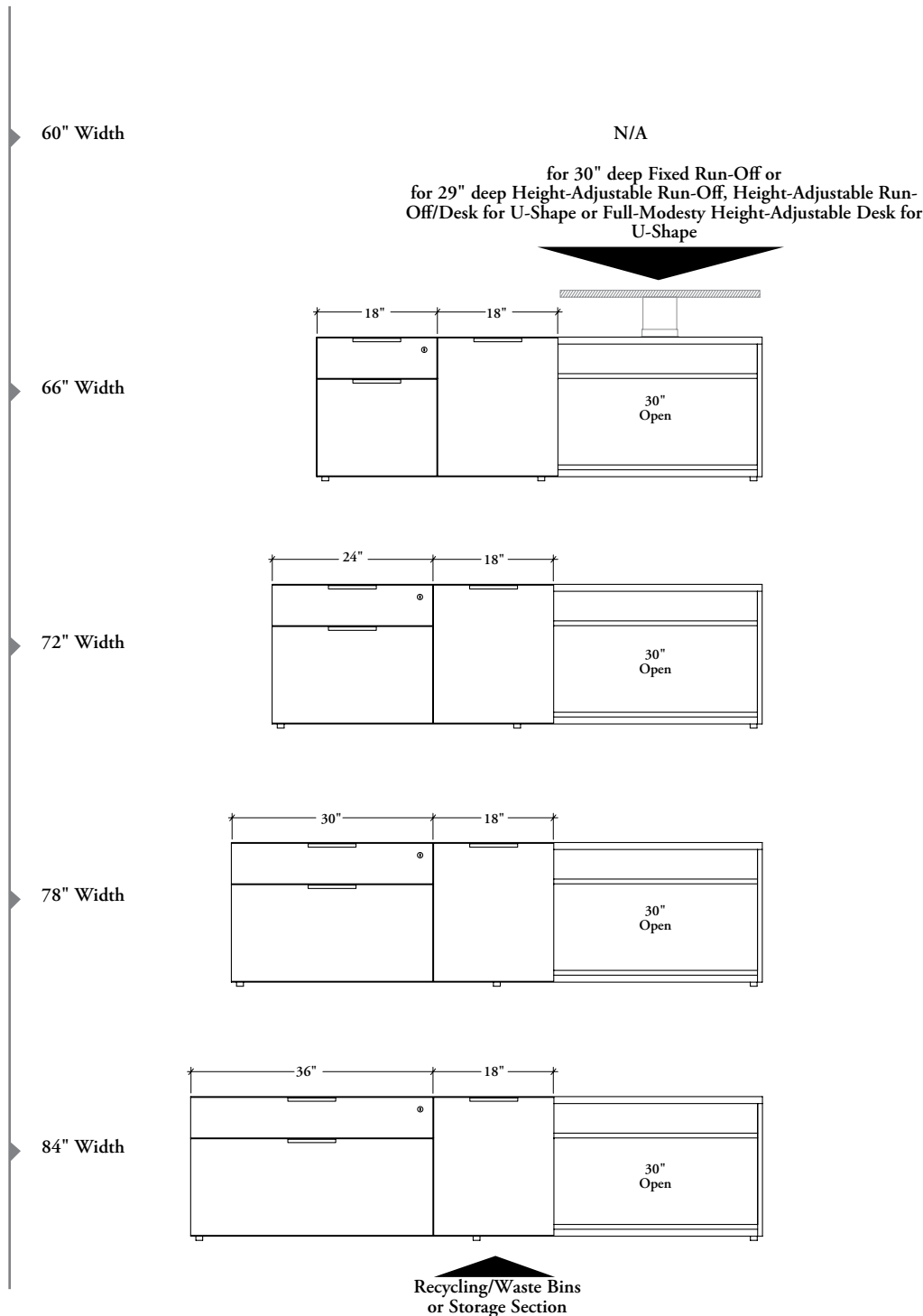

# workwall credenzas for fixed or height-adjustable worksurfaces – drawer widths (continued)

workwall credenza with with open & combo – fixed-worksurface – mid – 21" h (BSMCFW) or  
 workwall credenza with with open & combo – height-adjustable run-off – mid – 21" h (BSMCHR)  
 workwall credenza with with open & combo – height-adjustable peninsula – mid – 21" h (BSMHCP)

Only Drawers on Left (L) is shown

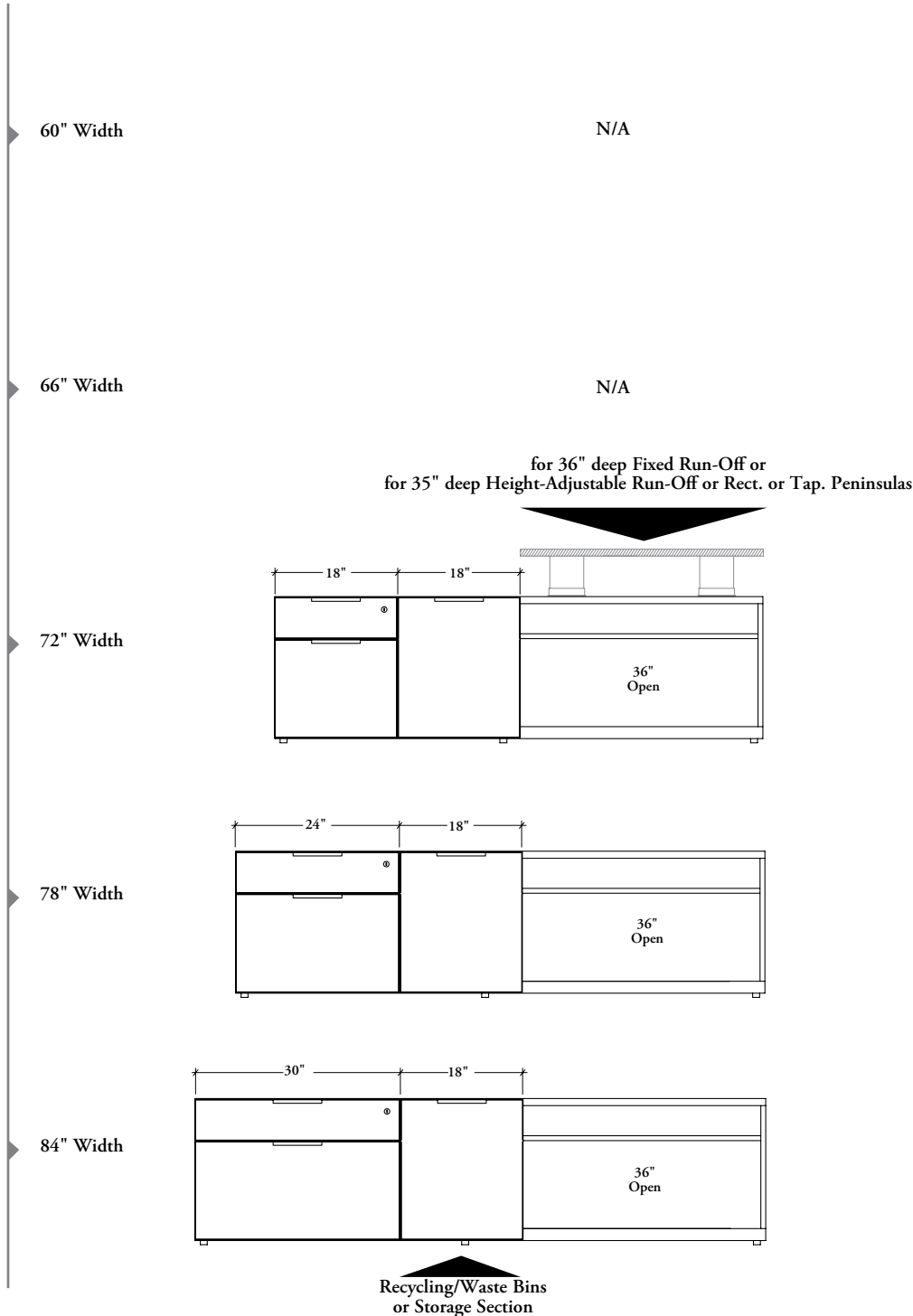

# workwall credenzas for fixed or height-adjustable worksurfaces – drawer widths (continued)

workwall credenza with with open & combo – fixed-worksurface – mid – 21" h (BSMCFW) or  
 workwall credenza with with open & combo – height-adjustable peninsula – mid – 21" h (BSMHCP)

Only Drawers on Left (L) is shown

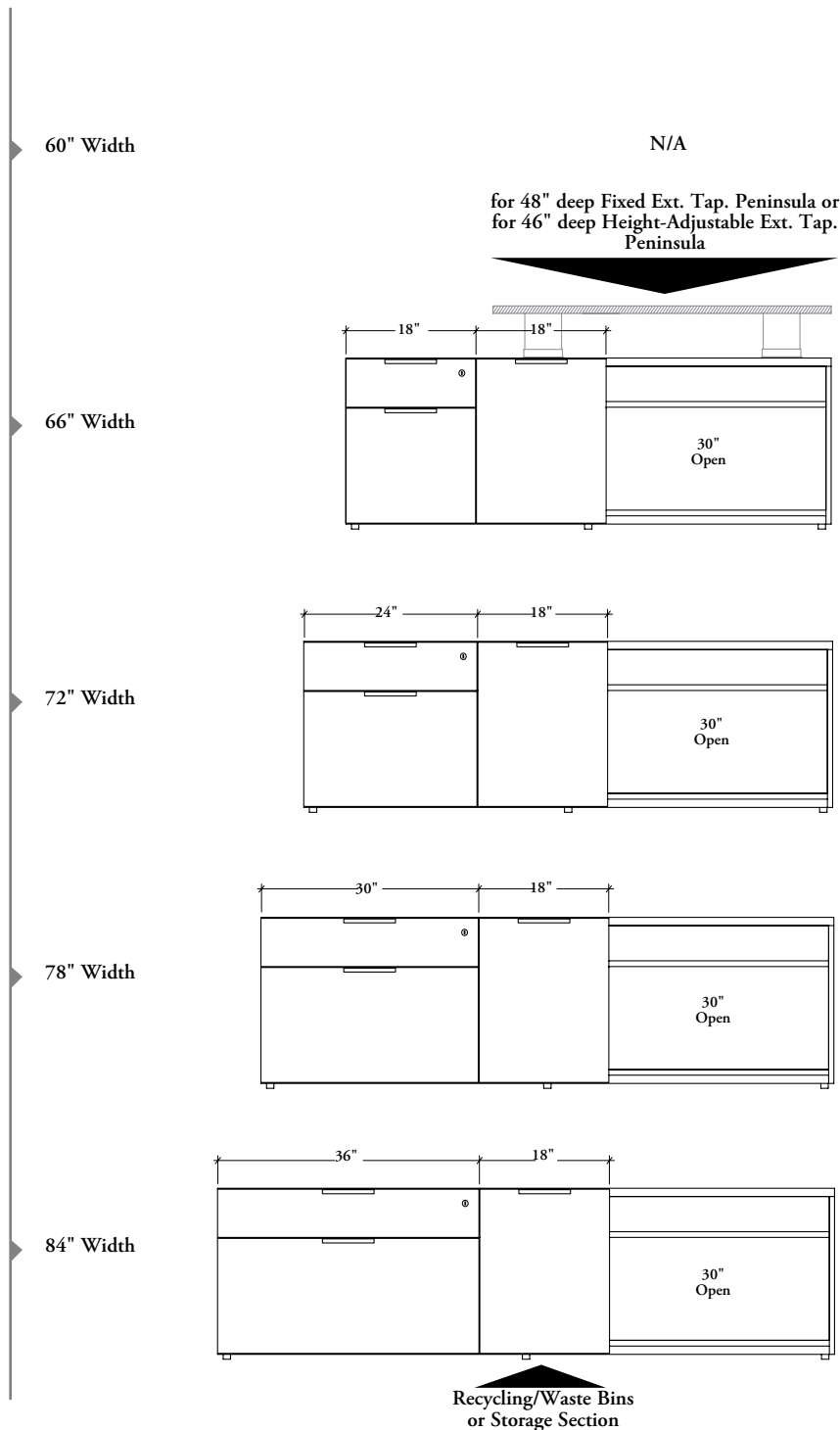



# workwall credenzas for fixed or height-adjustable worksurfaces – drawer widths (continued)

workwall credenza with with open & combo – fixed-worksurface – mid – 21" h (BSMCFW) or  
 workwall credenza with with open & combo – height-adjustable peninsula – mid – 21" h (BSMHCP)

Only Drawers on Left (L) is shown

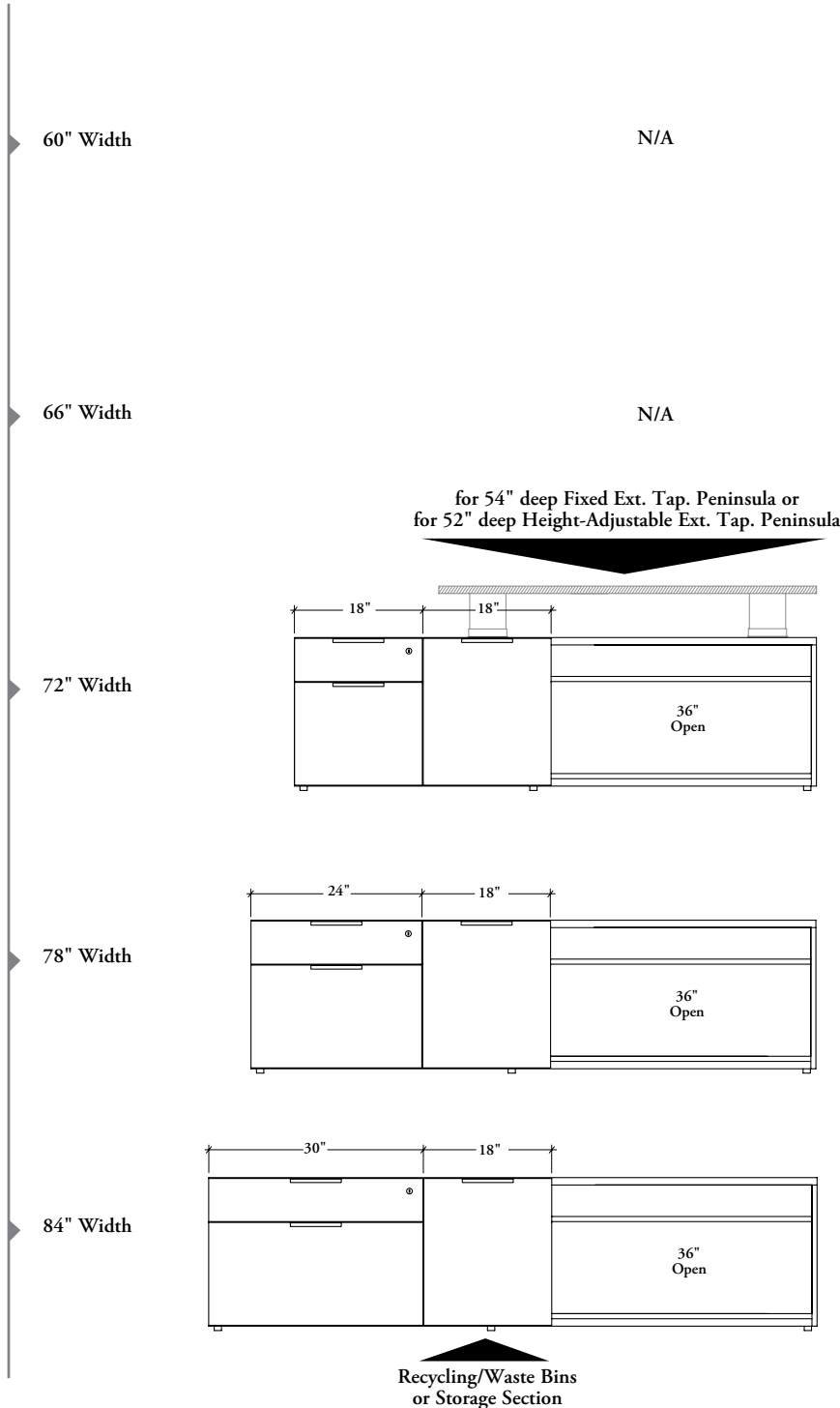

## workwall credenza – mid –21" h – interior clearance

The following outline the interior clearance available for all mid-height Workwall Bookcases.

### interior clearance height

- The open section features holes at 1 1/4" intervals on the interior walls, allowing for convenient adjustment of shelf height
- The following height dimension listed below are available for all mid-height Workwall Credenzas and Mid-Height Credenza (BSMFL) of the Freestanding Storage & Accessories section

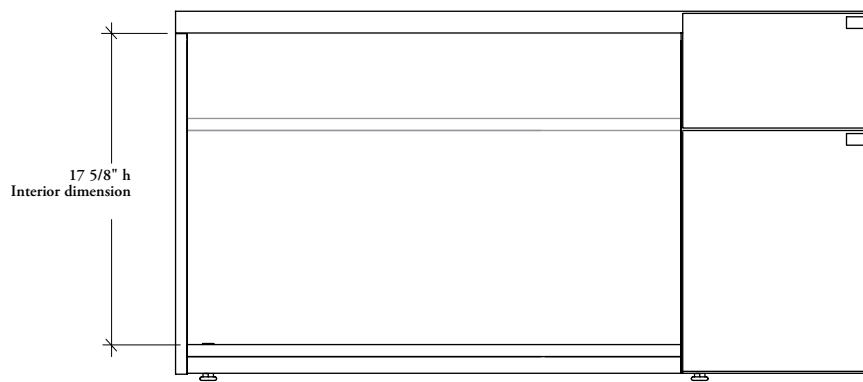

### interior clearance depth (20" deep shown)

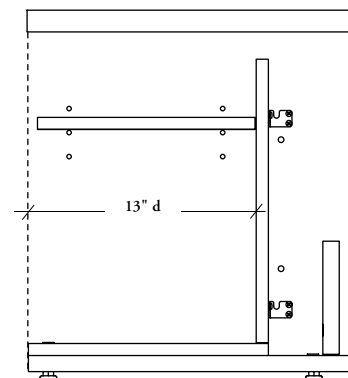

### drawer depths

All mid-height Workwall Credenzas with drawers feature 12" deep Box Drawer and 15" deep File Drawer. Only exceptions are 48" or 54" wide Workwall Credenza for Media with Open and Drawers – Mid – 21" h (BSMDOD) which feature 15" deep Box Drawer

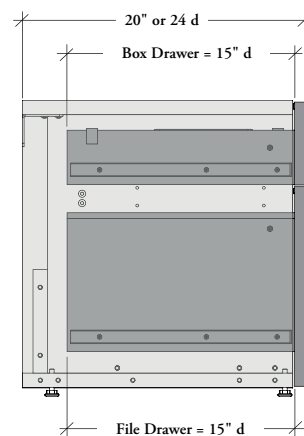
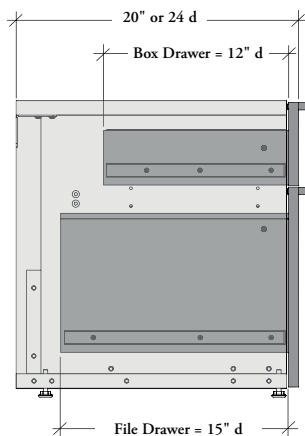

# workwall credenzas – mid – 21" h for fixed or height-adjustable worksurfaces – filing drawer capacities

Lateral file drawer mid-height Workwall Credenzas capacities are shown below.

- The dimensions listed below are inside drawer
- These dimensions are also available for Mid-Height Credenza (BSMFL) of the Freestanding Storage & Accessories section



\* The Letter or A4 paper size is allowed but require optional Hanging File Bar (RSLB)

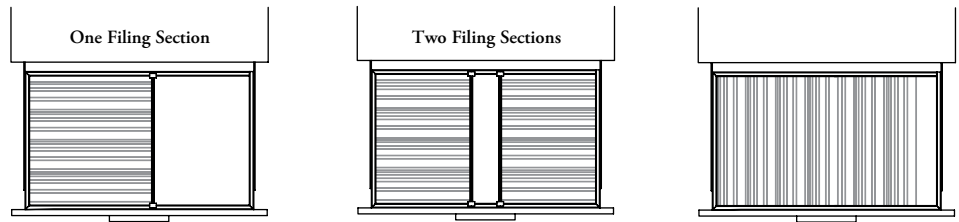

Front-to-Back

Front-to-Back

Side-to-Side

## 15 1/2" wide drawer

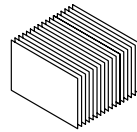
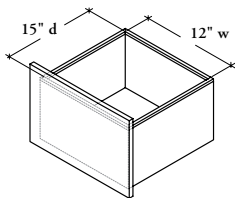

**Paper Sizes Allowed:**

- Letter
- A4

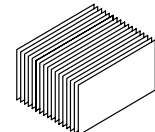

**Paper Size Allowed:**

- Legal

## 18" wide drawer

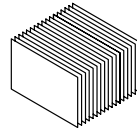
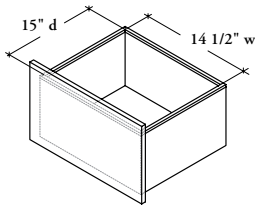

**Paper Sizes Allowed:**

- Letter
- A4

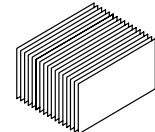

**Paper Size Allowed:**

- Legal

## 24" wide drawer

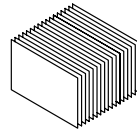
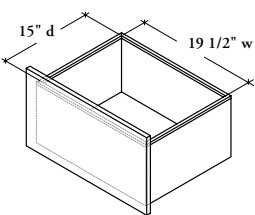

**Paper Sizes Allowed:**

- Letter
- A4
- Legal

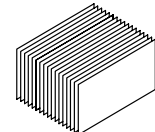

**Paper Sizes Allowed:**

- Letter\*
- A4\*
- Legal

## 30" wide drawer

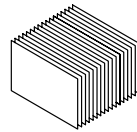
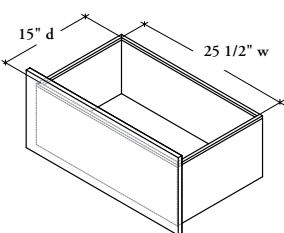

**Paper Sizes Allowed:**

- A4
- Legal

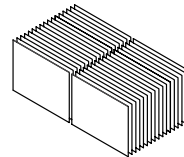

**Paper Size Allowed:**

- Letter

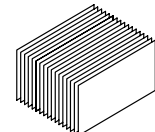

**Paper Sizes Allowed:**

- Letter\*
- A4\*
- Legal

## 36" wide drawer

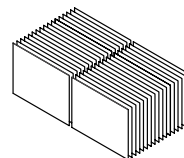
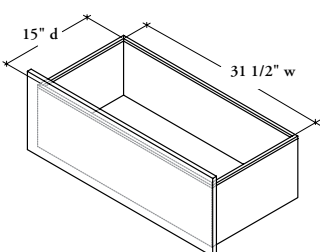

**Paper Sizes Allowed:**

- Letter
- A4
- Legal

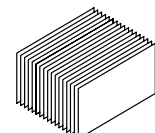

**Paper Sizes Allowed:**

- Letter\*
- A4\*
- Legal

# planning with workwall credenzas – mid – 21" h for fixed or height-adjustable worksurfaces

⚠ Credenzas are configured based on worksurface style and dimension to ensure that drawers are **not** located underneath worksurface. For some configurations, the door of mid-height Workwall Credenza with Open and Combo – Fixed Worksurface (BSMCFW) or mid-height Workwall Credenza with Open and Combo – Height-Adjustability (BSMCHR (Shown) or BSMHCP) may be located underneath the worksurface.

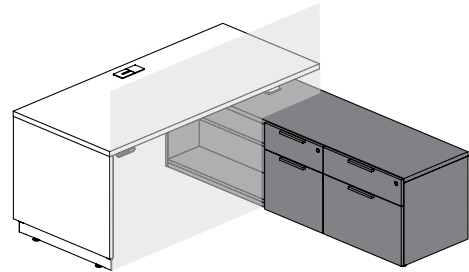
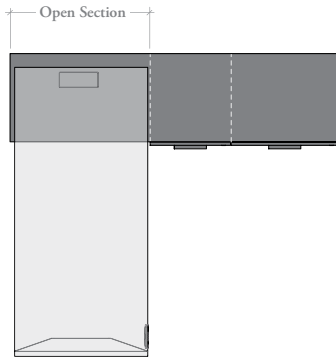

Fixed Extended Tapered Peninsula with Workwall Credenza with Open and Combo – Fixed Worksurface (BSMCFW) or Height-Adjustable Extended Tapered Peninsula with Workwall Credenza with Open and Combo – Height-Adjustability (BSMCHR or BSMHCP)

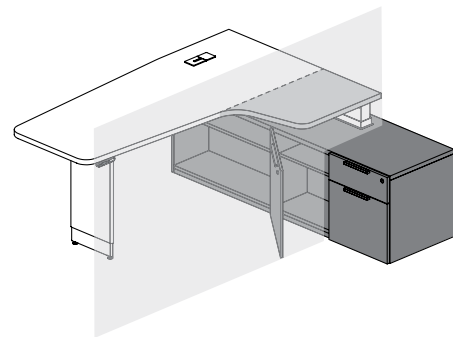
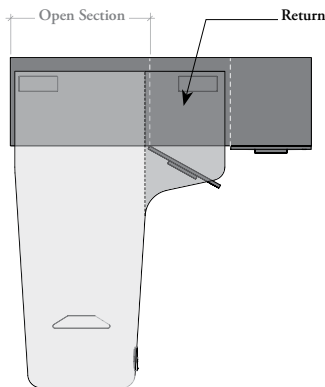

Recycling/waste bins or storage section is located underneath worksurface

Height-Adjustable Peninsula with mid-height Workwall Credenza with Open and Combo – Height-Adjustable Peninsula (BSMHCP)

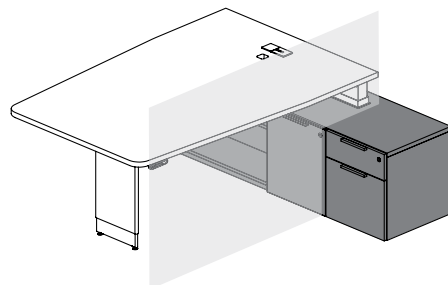
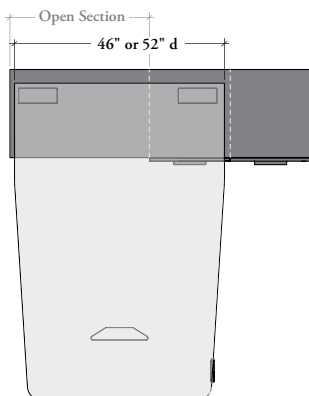

When a 46" or 52" deep Height-Adjustable Peninsula is specified above a mid-height Workwall Credenza with Open and Combo – Height-Adjustable Peninsula, the recycling/waste bins or storage section is **more difficult to access**, because the surface covered completely the storage access

# workwall storage – product offering

⚠ All dimensions on this page are actual

## Workwall Kneespace Module – Height-Adjustable (BHKHW)

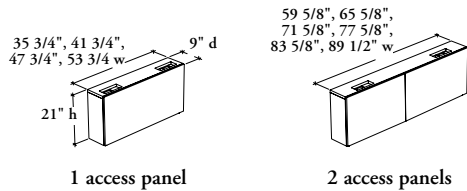

## Workwall Kneespace Module – Full-Modesty Height-Adjustable Run-Off (BHKHM)

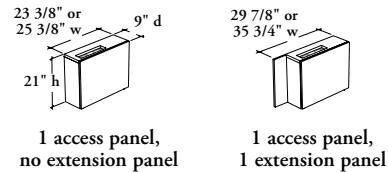

## Workwall Kneespace Module – Full-Modesty Height-Adjustable Extended or "L" Run-Off (BHKHL)

For 29" depth A

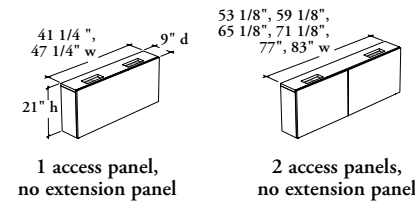

For 35" depth A

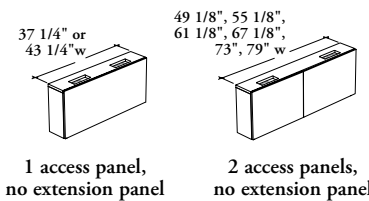

For 29" or 35" depth A

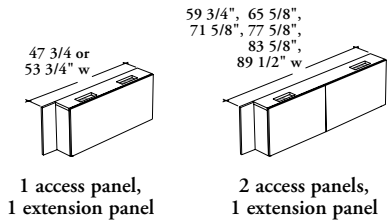

## Workwall Kneespace Module – Height-Adjustability and Fixed Worksurface (BHKHF)

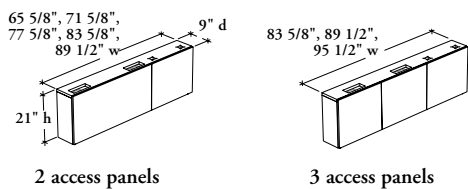

## Workwall Kneespace Module – Fixed Worksurface (BHKFW)

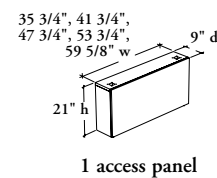

## Workwall Kneespace Module – Fixed Worksurface (BHKFR)

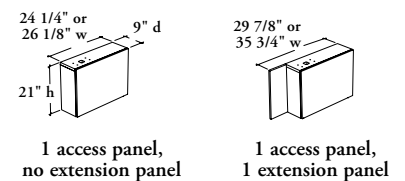

## Workwall Bookcase – Mid – 21" h (BSMO)

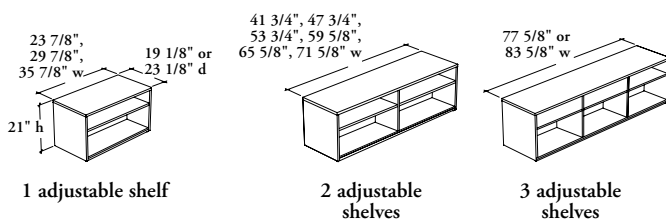

## Workwall Bookcase – Fixed Worksurface – Mid – 21" h (BSMOBW)

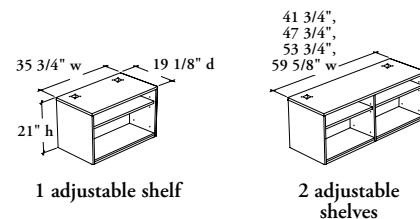

## workwall storage – product offering (continued)

⚠ All dimensions on this page are actual

**Workwall Bookcase – Height-Adjustable Worksurface – Mid – 21" h (BSMOBH)**

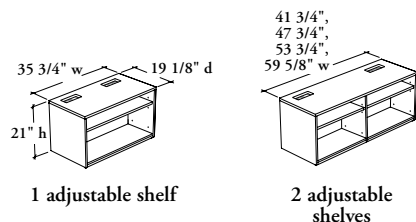

**Workwall Bookcase – Integral Top – 29" h (BSOBT)**

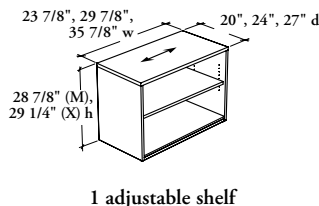

**Workwall Bookcase – Integral Top – 29" h – Cross Grain (BSOBC)**

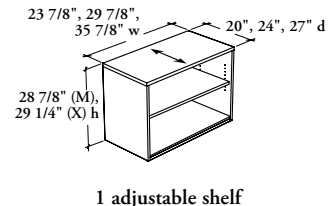

**Workwall Cabinet – Mid – 21" h – (BSMD)**

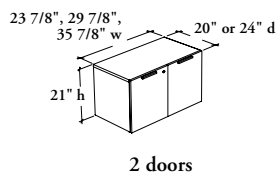

**Workwall Cabinet – Integral Top – 29" h (BSCT)**

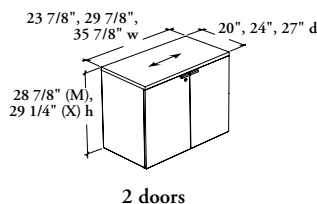

**Workwall Cabinet – Integral Top – 29" h – Cross Grain (BSDC)**

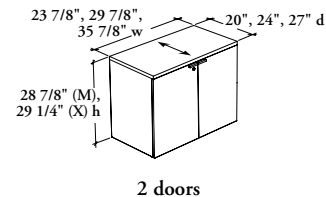

**Workwall Lateral Files – Integral Top – 29" h (BSLFT)**

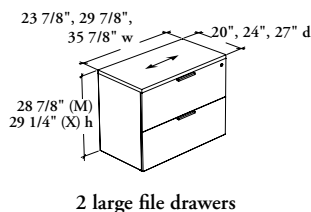

**Workwall Lateral Files – Integral Top – 29" h – Cross Grain (BSLFC)**

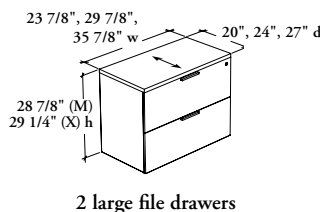

**Workwall Stretch Pedestal – Mid – 21" h (BSMSSP)**

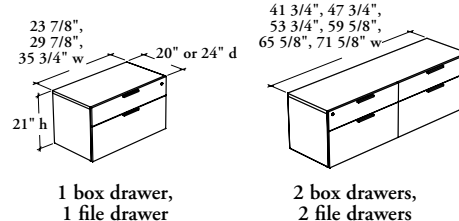

**Workwall Stretch Pedestal – Integral Top – 29" h (BSPT)**

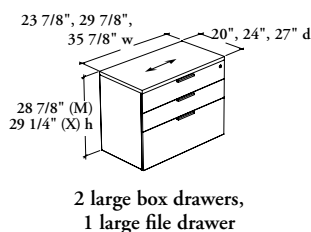

**Workwall Stretch Pedestal – Integral Top – 29" h – Cross Grain (BSPC)**

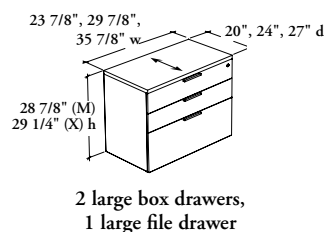

**Workwall Credenza with Cabinet and Drawers – Mid – 21" h (BSMCD)**

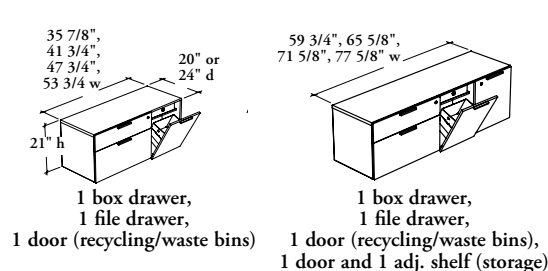

# workwall storage – product offering (continued)

⚠ All dimensions on this page are actual

## Workwall Credenza with Open and Drawers – Mid – 21" h (BSMOD)

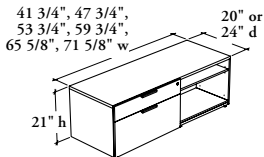

1 box drawer,  
1 file drawer,  
1 adjustable shelf (open)

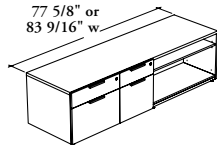

2 box drawers,  
2 file drawers,  
1 adjustable shelf (open)

## Workwall Credenza with Open and Drawers – Fixed Worksurface – Mid – 21" h (BSMWL)

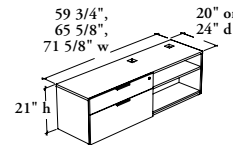

1 box drawer,  
1 file drawer,  
1 adjustable shelf (open)

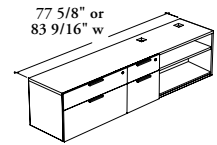

2 box drawers,  
2 file drawers,  
1 adjustable shelf (open)

## Workwall Credenza with Open and Drawers – Height-Adjustable Run-Off – Mid – 21" h (BSMHLR)

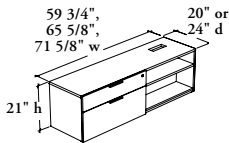

1 box drawer,  
1 file drawer,  
1 adjustable shelf (open)

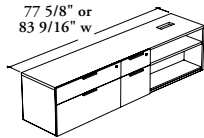

2 box drawers,  
2 file drawers,  
1 adjustable shelf (open)

## Workwall Credenza with Open and Drawers – Height-Adjustable Peninsula – Mid – 21" h (BSMHDP)

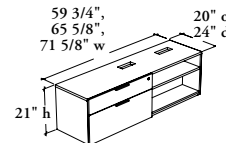

1 box drawer,  
1 file drawer,  
1 adjustable shelf (open)

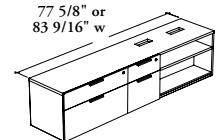

2 box drawers,  
2 file drawers,  
1 adjustable shelf (open)

## Workwall Credenza for Media with Open and Drawers – Mid – 21" h (BSMDOD)

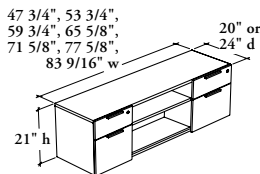

2 box drawers,  
2 file drawers,  
1 adjustable shelf (open)

## Workwall Credenza with Open and Combo – Fixed Worksurface – Mid – 21" h (BSMCFW)

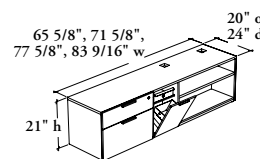

1 box drawer,  
1 file drawer,  
1 door (recycling/waste bins),  
1 adjustable shelf (open)

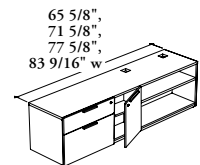

1 box drawer,  
1 file drawer,  
1 door and 1 adj. shelf (storage),  
1 adjustable shelf (open)

## Workwall Credenza with Open and Combo – Height-Adjustable Run-Off – Mid – 21" h (BSMCHR)

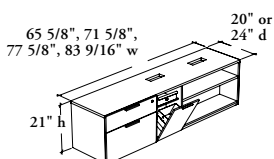

1 box drawer,  
1 file drawer,  
1 door (recycling/waste bins),  
1 adjustable shelf (open)

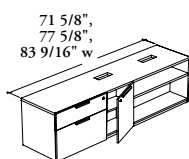

1 box drawer,  
1 file drawer,  
1 door and 1 adj. shelf (storage),  
1 adjustable shelf (open)

## Workwall Credenza with Open and Combo – Height-Adjustable Peninsula – Mid – 21" h (BSMHCP)

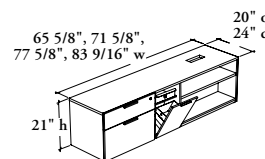

1 box drawer,  
1 file drawer,  
1 door (recycling/waste bins),  
1 adjustable shelf (open)

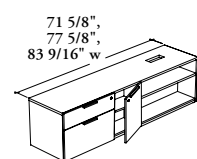

1 box drawer,  
1 file drawer,  
1 door and 1 adj. shelf (storage),  
1 adjustable shelf (open)

## workwall storage – lock chart

⚠ If specified, all closed storage products come with a lock and key set and can be keyed alike or randomly. A Key Chart must accompany every order, otherwise orders will be shipped keyed randomly

Workwall Cabinet – Mid – 21" h (BSMD)

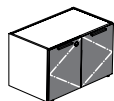

number of locks	1 x
-----------------	-----

Workwall Cabinet – Integral Top – 29" h (BSCT) or Workwall Cabinet – Integral Top – 29" h – Cross Grain (BSDC)

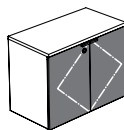

number of locks	1 x
-----------------	-----

Workwall Lateral – Integral Top – 29" h (BSLFT) or Workwall Lateral – Integral Top – 29" h – Cross Grain (BSLFC)

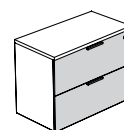

number of locks	1 x
-----------------	-----

Workwall Stretch Pedestal – Mid – 21" h (BSMSSP)

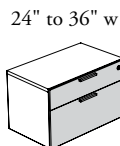

OR

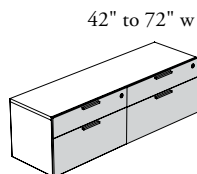

number of locks	1 x	2 x
-----------------	-----	-----

Workwall Stretch Pedestal – Integral Top – 29" h (BSPT) or Workwall Stretch Pedestal – Integral Top – 29" h – Cross Grain (BSPC)

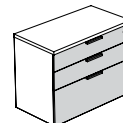

number of locks	1 x
-----------------	-----

Workwall Credenza with Cabinet and Drawers – Mid – 21" h (BSMCD)

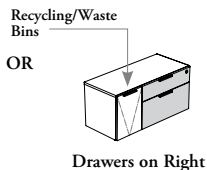
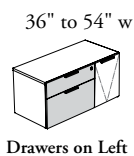

number of locks	1 x
-----------------	-----

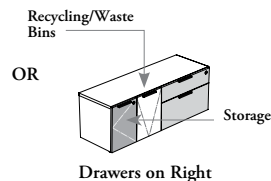
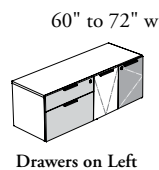

number of locks	2 x
-----------------	-----

Workwall Credenza with Open and Drawers – Mid – 21" h (BSMOD)

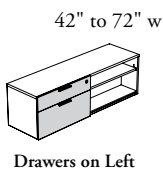

OR

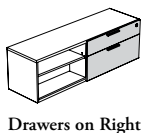

number of locks	1 x
-----------------	-----

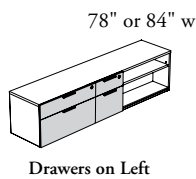

OR

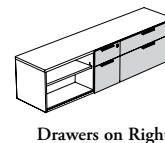

number of locks	2 x
-----------------	-----

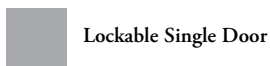



# workwall storage – lock chart (continued)

## Workwall Credenza with Open and Drawers – Fixed Worksurface – Mid – 21" h (BSMWL)

Available for following configurations:

- 60" w X 30" d
- 60" w X 36" d
- 66" w X 30" d
- 66" w X 36" d
- 72" w X 36" d

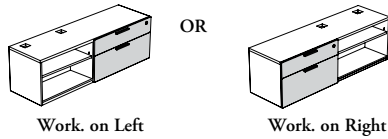

Available for following configurations:

- 72" w X 30" d
- 78" w X 30" d
- 78" w X 36" d
- 84" w X 30" d
- 84" w X 36" d

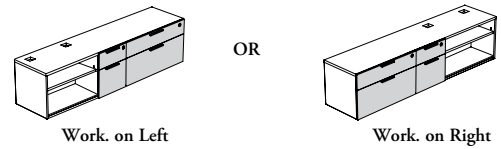

number of locks	1 x	2 x
-----------------	-----	-----

## Workwall Credenza with Open and Drawers – Height-Adjustable Run-Off – Mid – 21" h (BSMHLR) or Workwall Credenza with Open and Drawers – Height-Adjustable Peninsula – Mid – 21" h (BSMHDP)

Available for following configurations:

- 60" w X 29" d
- 60" w X 35" d
- 66" w X 29" d
- 66" w X 35" d
- 72" w X 35" d

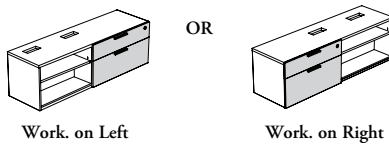

Available for following configurations:

- 72" w X 29" d
- 78" w X 29" d
- 78" w X 35" d
- 84" w X 29" d
- 84" w X 35" d

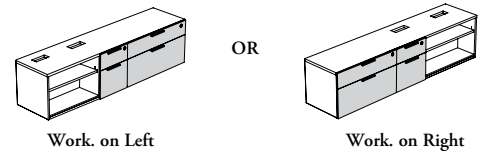

number of locks	1 x	2 x
-----------------	-----	-----

## Workwall Credenza for Media with Open and Drawers – Mid – 21" h (BSMDOD)

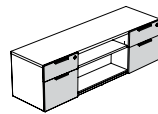

number of locks	2 x
-----------------	-----

## Workwall Credenza with Open and Combo – Fixed Worksurface – Mid – 21" h (BSMCFW)

Available for following configurations:

- 66" w X 30" d
- 66" w X 48" d
- 72" w X 30" d
- 72" w X 36" d
- 72" w X 48" d
- 72" w X 54" d
- 78" w X 30" d
- 78" w X 36" d
- 78" w X 48" d
- 78" w X 54" d
- 84" w X 30" d
- 84" w X 36" d
- 84" w X 48" d
- 84" w X 54" d

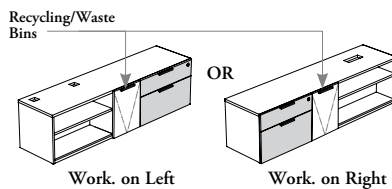

Available for following configurations:

- 66" w X 30" d
- 66" w X 48" d
- 72" w X 30" d
- 72" w X 36" d
- 72" w X 48" d
- 72" w X 54" d
- 78" w X 30" d
- 78" w X 36" d
- 78" w X 48" d
- 78" w X 54" d
- 84" w X 30" d
- 84" w X 36" d
- 84" w X 48" d
- 84" w X 54" d

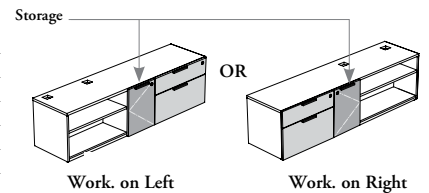

number of locks	1 x	2 x
-----------------	-----	-----

Lockable Single Door
  Lockable Drawers
  Not Lockable

# workwall storage – lock chart (continued)

**Workwall Credenza with Open Combo – Height-Adjustable Run-Off – Mid – 21" h (BSMCHR) or Workwall Credenza with Open Combo – Height-Adjustable Peninsula – Mid – 21" h (BSMHCP)**

Available for following configurations:

- 66" w X 29" d
- 72" w X 29" d
- 72" w X 35" d
- 78" w X 29" d
- 78" w X 35" d
- 84" w X 29" d
- 84" w X 35" d

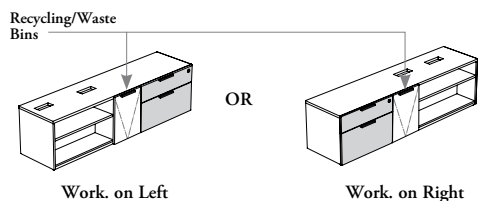

Available for following configurations:

- 66" w X 29" d
- 72" w X 29" d
- 72" w X 35" d
- 78" w X 29" d
- 78" w X 35" d
- 84" w X 29" d
- 84" w X 35" d

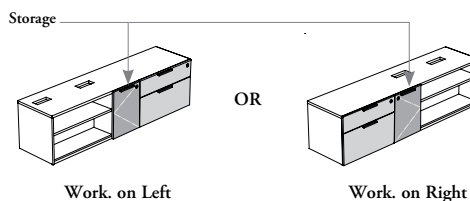

number of locks	1 x	2 x
-----------------	-----	-----

Lockable Single Door
  Lockable Drawers
  Not Lockable

# workwall storage – connecting devices

The following outline the connecting devices available for all mid-height Workwall Storage.

- All Workwall Storage can be connected **together** and with Freestanding Towers or Stretch Pedestal of the Freestanding Storage & Accessories section
- This supplied hardware ensures a perfect installation
- Can only be connected with following Freestanding Storage:

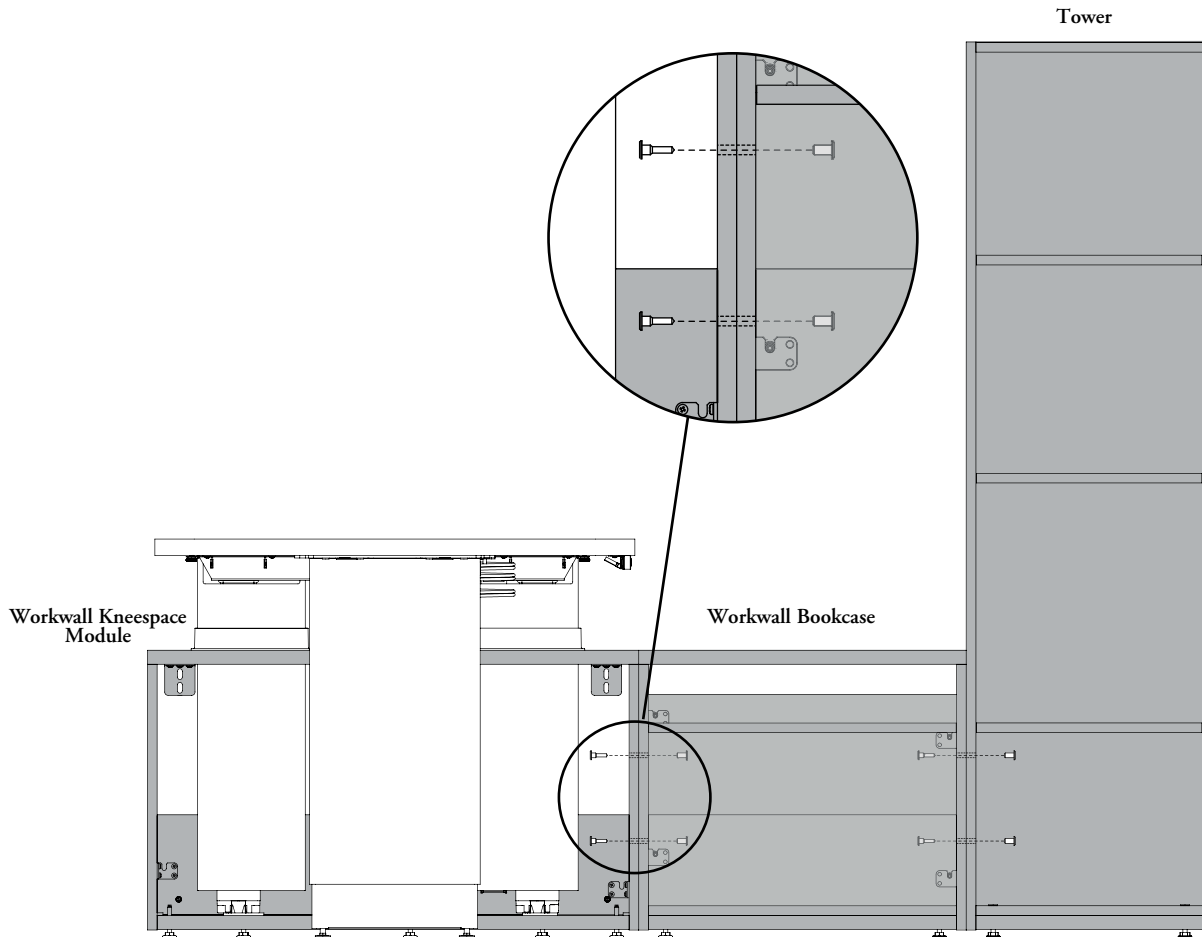
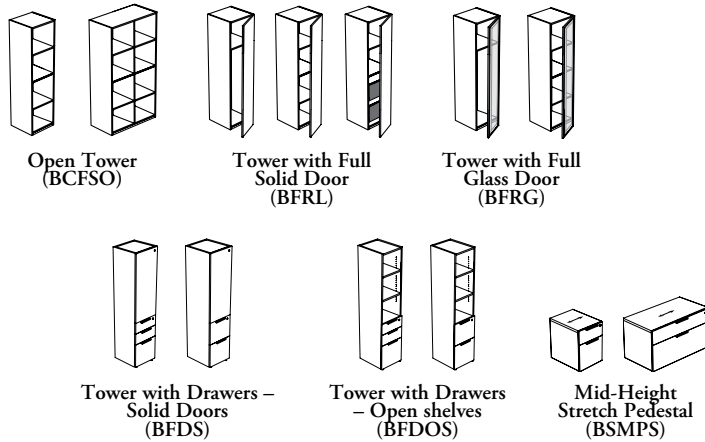

## workwall storage finishes

❗ For an overview of which products are offered in Flintwood finishes, refer to the Expansion Casegoods product map on Teknion's website

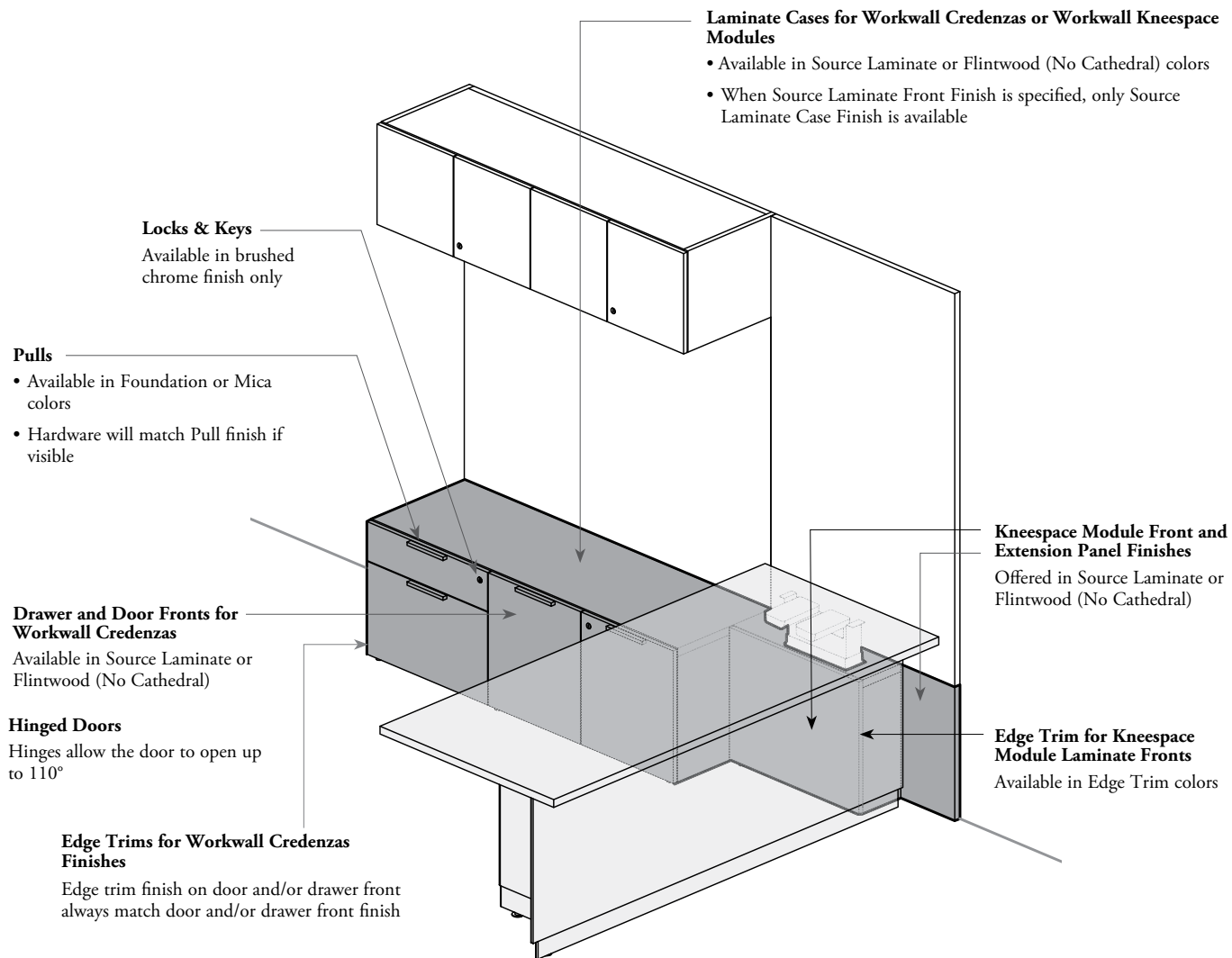

## workwall storage finishes (continued)

### Case Finishes for Workwall Cabinet, Workwall Storage with or without Integral Top or Workwall Bookcases

- Offered in Source Laminate or Flintwood (No Cathedral)
- When Foundation Laminate Worksurface Finish is specified, only Source Laminate Case Finish is available
- When Source Laminate Door Front Finish is specified, only Source Laminate Case Finish is available

### Drawer and Door Fronts for Workwall Cabinets, Lateral Files or Stretch Pedestals

- Available in Source Laminate or Flintwood (No Cathedral) only

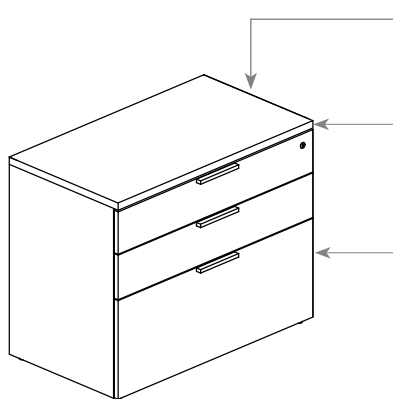
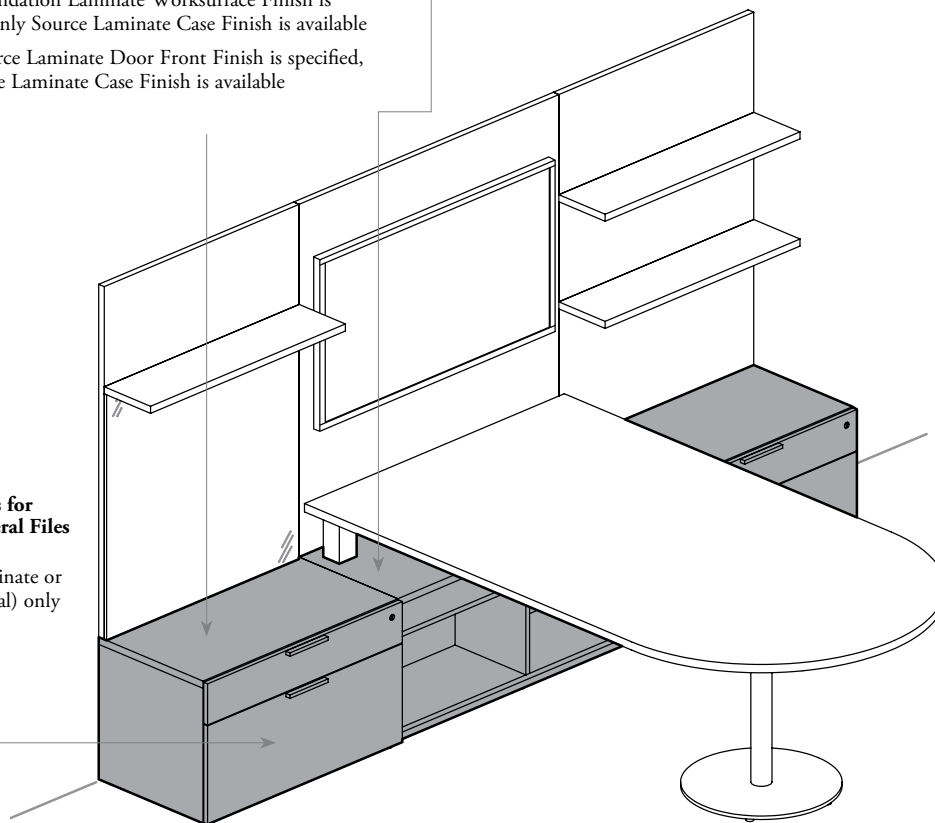

### Integral Top

- 1 3/16" thickness (M) available in Foundation Laminate colors
- 1 9/16" thickness (X) available in Foundation Laminate colors (Storm White, Very White, Crisp Grey, Soft Gris or Wood Prints colors only)
- Also available in Flintwood (No Cathedral) for Integral Top only

### Edge Trims Styles & Finishes

- Available in Straight Trim (6), Flat Trim (8) or Flintwood Flat Trim (9)
- Available in Edge Trim colors (for trim style 6 or 8)
- For Workwall Stretch Pedestals (BSMSSP), the edge trim finish on drawer front always match drawer front finish
- For Workwall Storage (BSMD, BSMCD, BSMOD), the edge trim finish on door front always match door front finish

## workwall storage – grain direction

### workwall storage

Door fronts grain direction will always be vertical

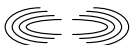
Laminate =  = Grain Direction = 

#### Cathedral Grain Pattern:

Source Laminate

- 3A – 3B – 3C – 3D – 3E – 3L – 3M – 3X – XQ – XR

For colors listed above, the Cathedral Grain Pattern for door and drawer fronts will be book-matched

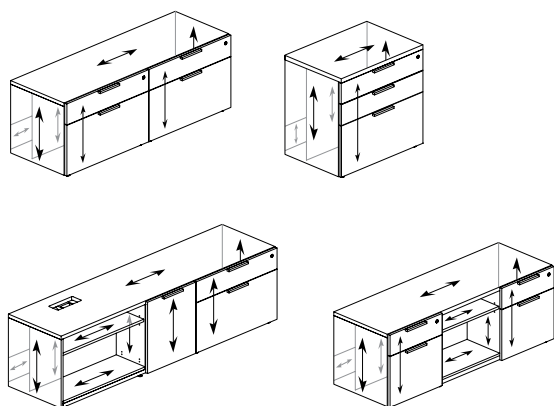

#### Straight Grain Pattern:

Source Laminate

- 3F – 3J – 3K – 3N – 3P – XJ – XK

Flintwood

- FC – FD – FM – FN – FX – NR – NT – VA – VB – VZ – 5N – 5P – 5Q – 5R – 5S – 5T – 5V – 5W – 5Z

For colors listed above, the Straight Grain Pattern for drawer fronts will be vertical

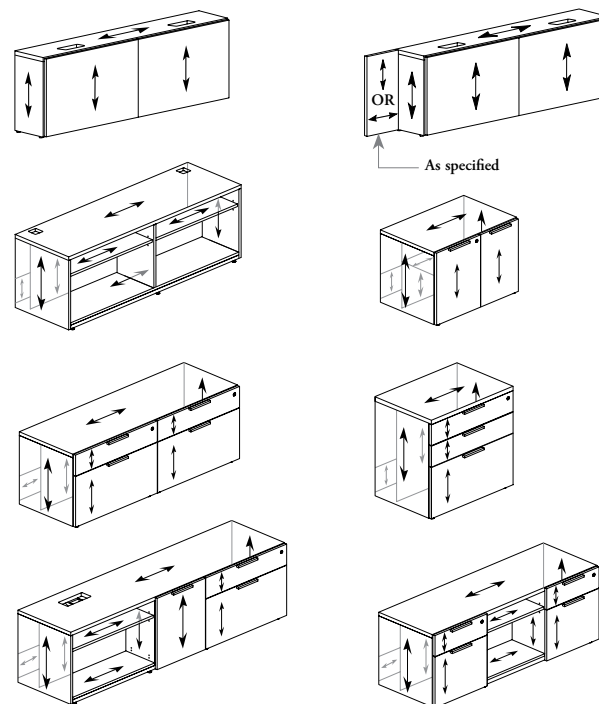

### flintwood surface grain/pattern direction

Flintwood =  = Grain Direction = 