

hiSpace Overview

hiSpace informally invites users to choose how to work in their work station. The name itself speaks to an introduction and a choice for the user to sit in a pleasant space or to stand at an elevated surface.

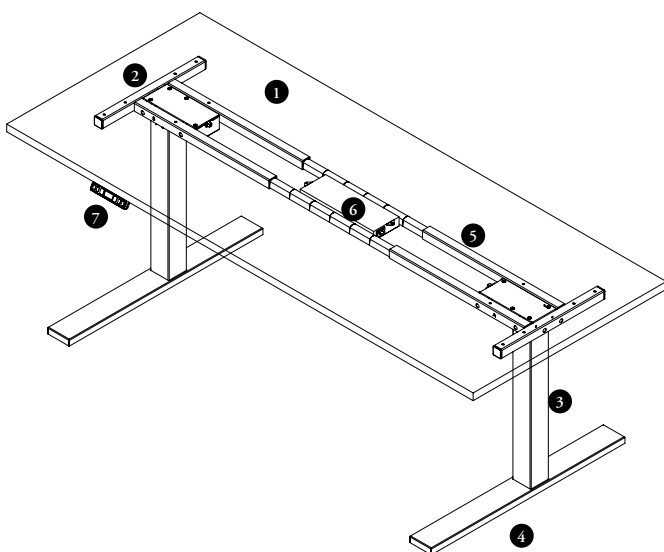

- ① Worksurface
- ② Strut
- ③ Leg
- ④ Foot
- ⑤ Telescopic Top Frame
- ⑥ Control Box
- ⑦ Handle/Switch

hiSpace freestanding tables are centered around a square profile leg, telescopic top frame, neutral foot and stowable digital display switch/crank handle.

hiSpace Table Basics

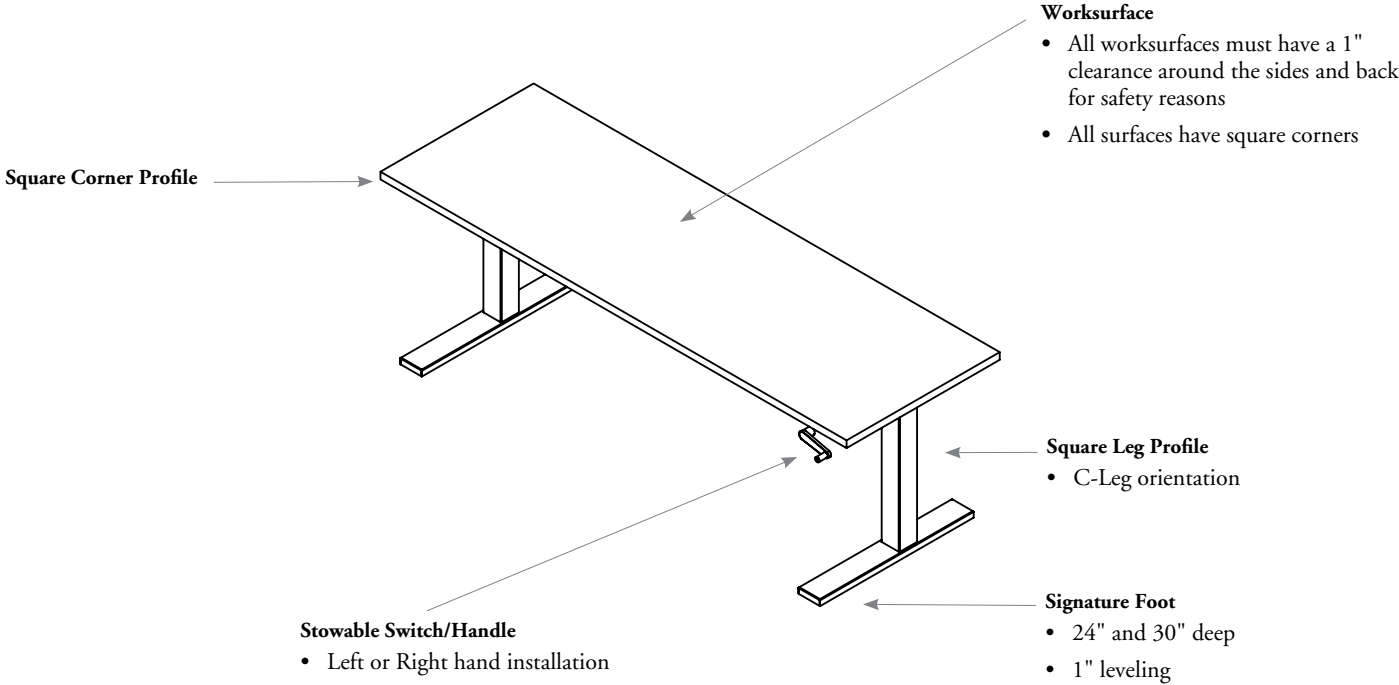

hiSpace Telescopic Frame

hiSpace is easily reconfigured to support five sizes of worksurface widths using its universal telescopic top frame.

Base Size: 48"

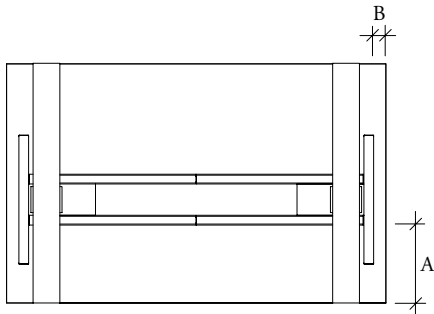

For 24" deep worksurface A = 10"
For 30" deep worksurface A = 13"
This is common for all worksurface widths.
B = 1.49"

Base Size: 54"

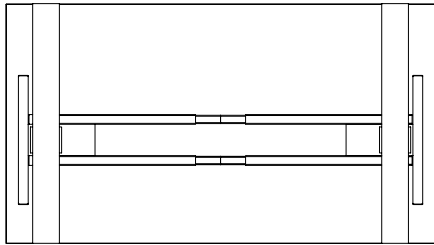

Base Size: 60"

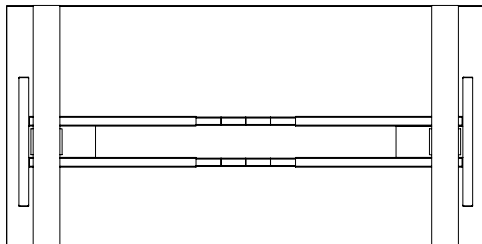

Base Size: 66" & 72"

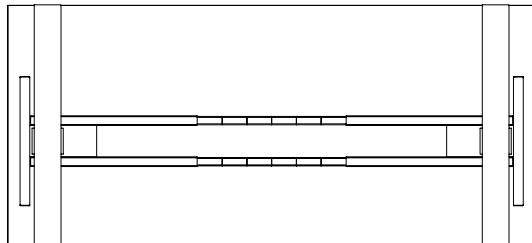

Base Size: 72"

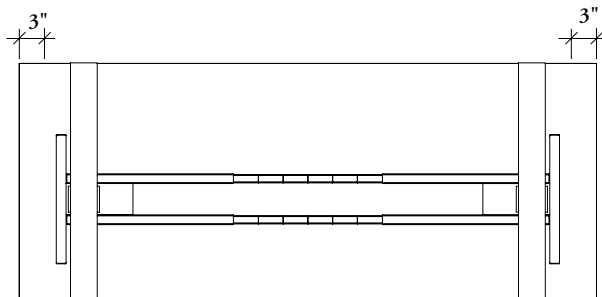

hiSpace is easily reconfigured to support five sizes of worksurface widths using its universal telescopic top frame.

hiSpace Telescopic Frame (Continued)

hispace base mechanism and surface dimensions

hiSpace Height-Adjustable Table – upStage Integrated Rectangular (YSHI)

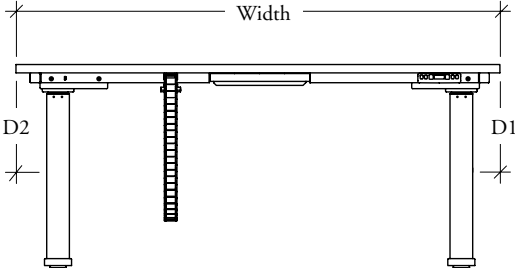

Left Orientation Shown

Width (actual)	D1	D2
46"	3.28"	3.71"
52"	3.28"	3.71"
58"	3.28"	3.71"
64"	3.28"	3.71"
70"	3.28"	3.71"

hiSpace Height-Adjustable Table – upStage Freestanding Rectangular (YSHU)

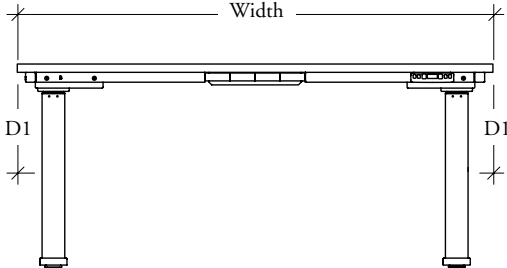

Width (actual)	D1
45"	3"
51"	3"
57"	3"
63"	3"
69"	3"

hiSpace Grommets

hiSpace Grommets allow clean, easy and aesthetically pleasing pass-through of wire beneath the worksurface.

grommets (optional)

Standard on all non upStage hiSpace Tables (YSRE).

Can be specified left, right or centered, and are inset 4" on center from the rear and 4" on center from the edge.

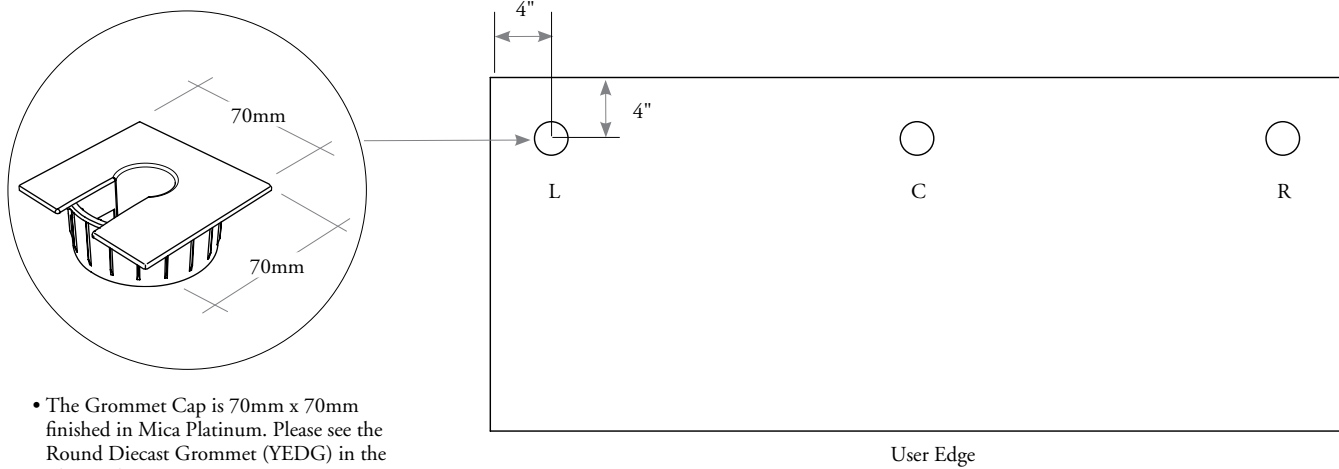

- The Grommet Cap is 70mm x 70mm finished in Mica Platinum. Please see the Round Diecast Grommet (YEDG) in the Electrical Section
- The Grommet hole is 2-3/4" diameter

grommets cut outs (optional)

Used on upStage specific hiSpace Tables (YSHT, YSHU).

Includes Rectangular Grommet cut out only.

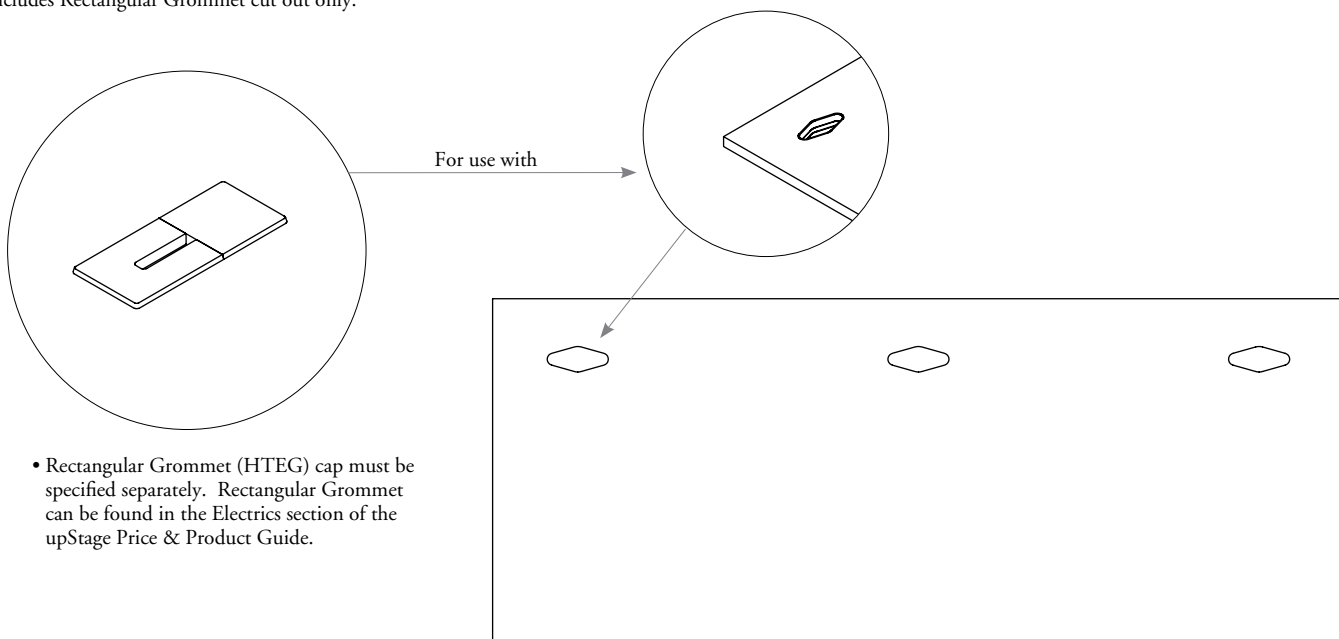





- Rectangular Grommet (HTEG) cap must be specified separately. Rectangular Grommet can be found in the Electrics section of the upStage Price & Product Guide.

The chart below indicates which edge trim styles can be specified with all hiSpace Height-Adjustable Table surface finishes.

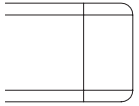
hiSpace Edge Trim Style Overview

All edge finishes will automatically default to match the surface finish selected with the exception of the Straight Trim (6), Bullnose Trim (2) and Flat Trim (8) which requires that an edge trim color be chosen.

		Source Laminate	Foundation Laminate Surface	Seamless Color Surface
Flat (8) All Edges 			✓	
Flat (G) All Edges 				✓
Full Knife (H) 			✓	
Full Knife (X) All Edges 				✓
Straight Trim (6) User Edge 	✓	✓		
Bullnose Trim (2) User Edge 		✓		

hiSpace Planning with Screens

A selection of District and Complements screens are available for use with the hiSpace tables. The following outlines the planning recommendations and restrictions for each.

screen application

Four styles of screens (including the District modesty panel) are recommended for use with the hiSpace table. The following chart outlines the compatible sizes.

Table Width	UNSM  Modesty Panel	YFXR  fx Table Rail	UNSD E  Desk Edge Screen	UNSFDE  Full Desk Edge Screen
42"	-	-	23" - 24", 36" - 40"	24" - 28"
48"	-	36" - 42"	23" - 34", 36", 42" - 46"	34" - 35", 42" - 46"
54"	24" - 36"	24", 48"	23" - 36", 48", 52"	23" - 24", 48" - 52"
60"	24" - 42"	24" - 30", 42", 54"	23" - 42", 49"	23" - 42", 54" - 58"
66"	24" - 48"	24" - 48", 60"	23" - 55"	23" - 48", 60" - 64"
72"	24" - 54"	24" - 54", 66"	23" - 61"	23" - 54", 66" - 70"
78"	24" - 60"	24" - 60", 72"	23" - 67"	23" - 59", 72" - 76"
84"	24" - 66"	24" - 66", 78"	23" - 73"	23" - 66", 78" - 82"

Table Width	YHMP  Height-Adjustable Modesty Panel	YHWT  Complements Wire Tray
42"	30" - 42"	42"
48"	30" - 48"	42", 48"
54"	30" - 54"	42" - 54"
60"	30" - 60"	42" - 60"
66"	30" - 66"	42" - 66"
72"	30" - 72"	42" - 72"
78"	30" - 78"	42" - 78"
84"	30" - 84"	42" - 84"

- Full Desk Edge Screen **not** to be used on hiSpace tables with 24" deep worksurfaces
- Desk Edge Screens in glass are **not** recommended for use with hiSpace tables

A selection of District and Complements screens are available for use with the hiSpace tables. The following outlines the planning recommendations and restrictions for each.

hiSpace Planning with Screens (Continued)

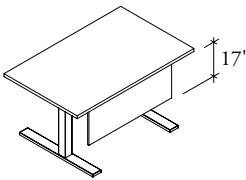
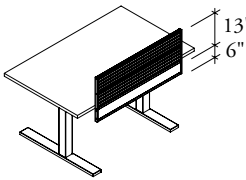
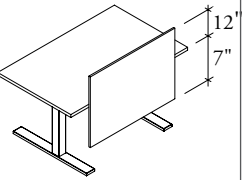
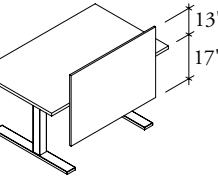
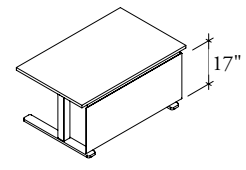
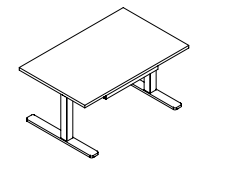
screen application

Four styles of screens (including the Modesty Panel) are recommended for use with the hiSpace Integrated/Freestanding Height-Adjustable Tables (YSHT/YSHU). The following chart outlines the compatible sizes.

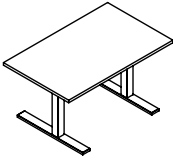
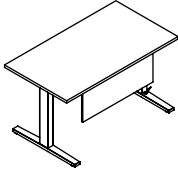
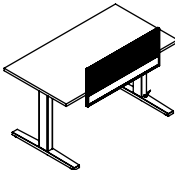
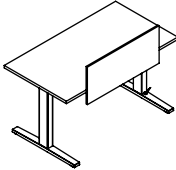
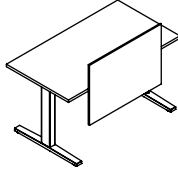
Table Width	YSHT/HU 	UNSM 	YFXR 	UNSD E 	UNSFDE 
42"	-	-	-	-	-
48"	24" - 36"	-	36" only	all sizes available	36" only
54"	24" - 42"	24" - 36"	24" only	24" - 36"	24" only
60"	24" - 48"	24" - 42"	24", 30", 42"	24" - 42"	24" - 42"
66"	24" - 54"	24" - 48"	24" - 48"	all sizes available	24" - 48"
72"	24" - 60"	24" - 42"	24" - 54"	all sizes available	24" - 54"