

LK48 GENEL

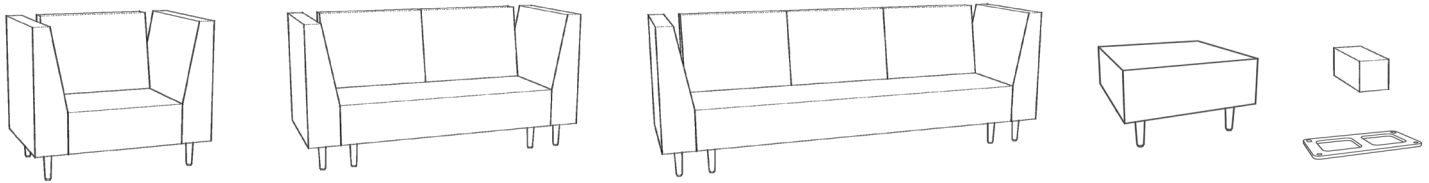

FEATURES

LK48 Genel Chair Sofa

- Legs in wood finish
- Optional undermount electrical available
- 300lbs weight capacity

LK48 Genel Lounge

- Two-seater and three-seater options
- Legs in wood finish
- Optional undermount electrical available
- 300lbs weight capacity per seat

LK48 Genel Ganging Kit

- Connects adjacent benches or sofas
- Ebony finish only
- Includes 1 x ganging plate, 4 x 5/16 - 18 x 1-1/4 screws and 4 x 11/16"OD x 5/16 ID washers
- Total length of any ganged configuration must not exceed 26ft

WEIGHTS

	WEIGHT (LBS)
LK48 GENEL CHAIR SOFA (IKNL)	150
LK48 GENEL LOUNGE, TWO-SEATER, RIGHT AND LEFT SIDE FACING (IKNK2B)	233
LK48 GENEL LOUNGE, TWO-SEATER, LEFT OR RIGHT SIDE FACING (IKNK2BL, IKNK2BR)	188
LK48 GENEL LOUNGE, THREE-SEATER, RIGHT AND LEFT SIDE FACING (IKNK3B)	302
LK48 GENEL LOUNGE, THREE-SEATER, LEFT OR RIGHT SIDE FACING (IKNK3L, IKNK3R)	260
LK48 GENEL CUSHION (IKNM)	7
LK48 GENEL BENCH (IKNP)	63

COM/COL MATERIAL REQUIREMENT

	UPHOLSTERY YARDAGE		LEATHER SQUARE FOOT	
	SEAT	ARM & BACK	SEAT	ARM & BACK
LK48 GENEL CHAIR SOFA (IKNL)	2.35	5.4	20.3	57.5
LK48 GENEL LOUNGE, TWO-SEATER, RIGHT AND LEFT SIDE FACING (IKNK2B)	3.95	6.85	34.1	72.5
LK48 GENEL LOUNGE, TWO-SEATER, LEFT OR RIGHT SIDE FACING (IKNK2BL, IKNK2BR)	3.95	4.85	34.1	51.5
LK48 GENEL LOUNGE, THREE-SEATER, RIGHT AND LEFT SIDE FACING (IKNK3B)	5.55	8.27	48.1	87.6
LK48 GENEL LOUNGE, THREE-SEATER, LEFT OR RIGHT SIDE FACING (IKNK3L, IKNK3R)	5.55	6.3	48.1	66.3
LK48 GENEL CUSHION (IKNM)	0.5	N/A	7.6	N/A
LK48 GENEL BENCH (IKNP)	3.5	N/A	20.3	N/A

LK48 GENEL continued

PLANNING

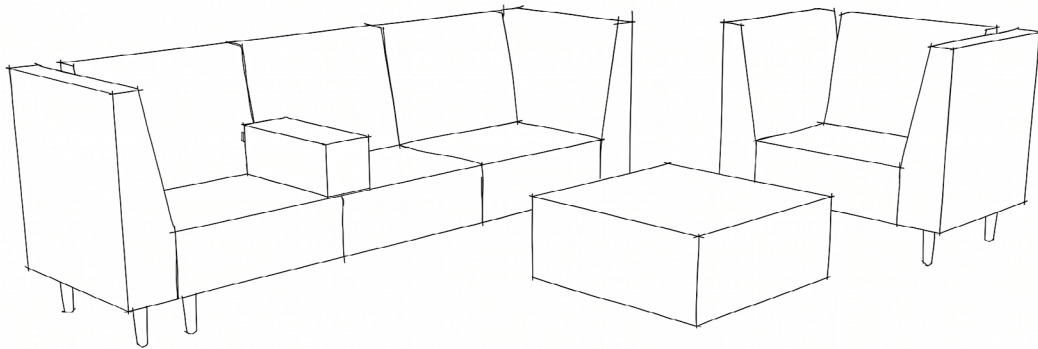
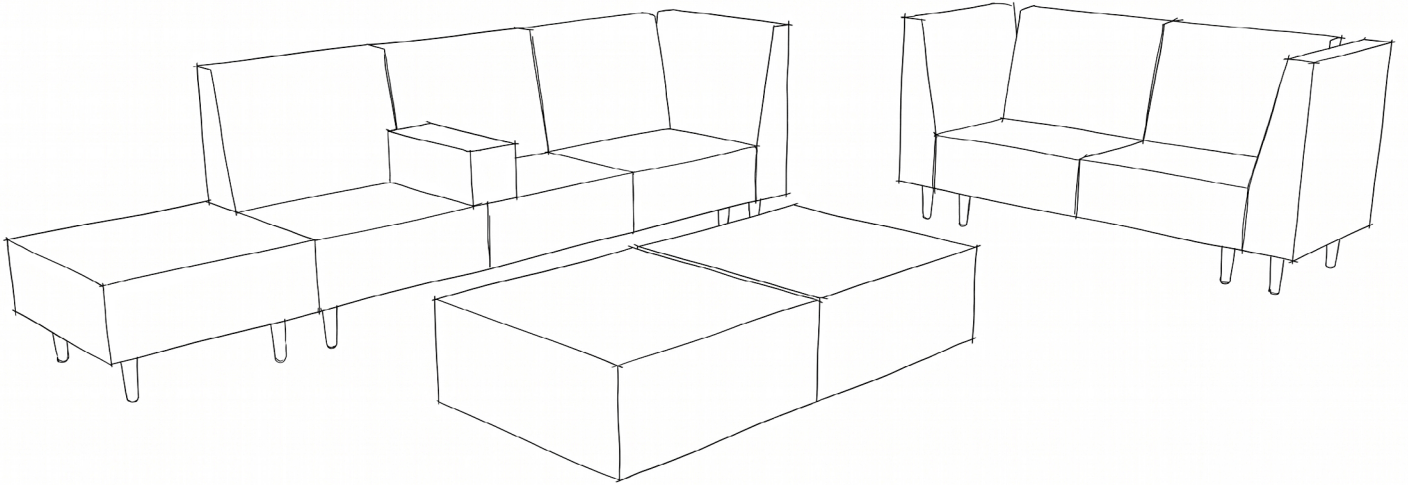

LK48 GENEL continued

DIMENSIONS & LEG POSITIONING

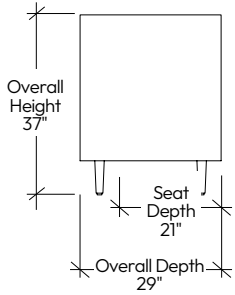

LK48 Genel
side view

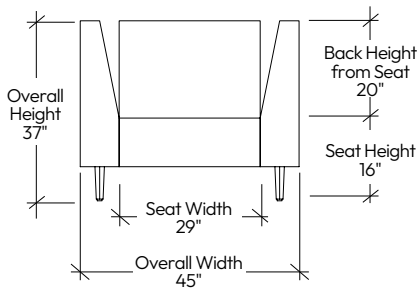

LK48 Genel Chair Sofa (IKNL)
front view

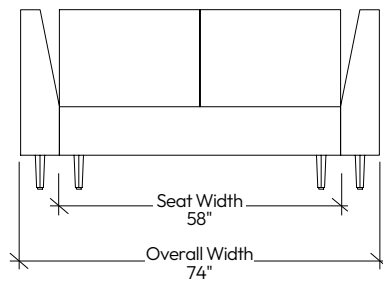

LK48 Genel Lounge, Two-Seater (IKNK2B)
front view

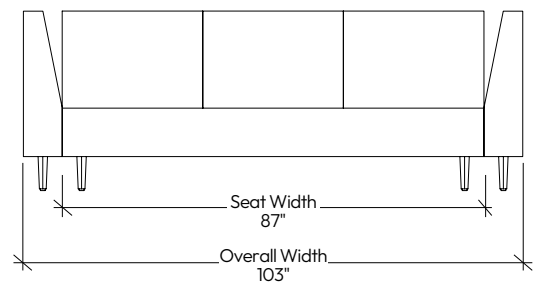

LK48 Genel Lounge, Three-Seater (IKNK3B)
front view

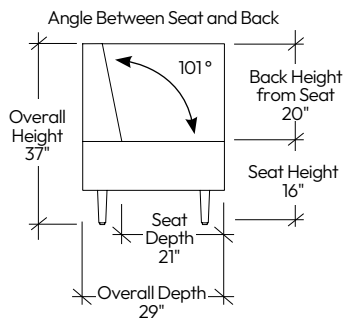

LK48 Genel Lounge, 1 Arm Bolster
side view

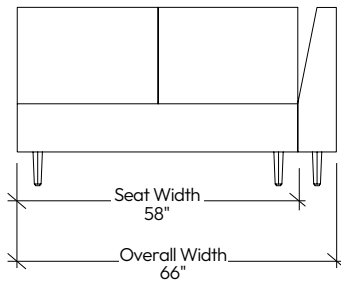

LK48 Genel Lounge, Two-Seater, Right Side Facing (IKNK2R)
front view

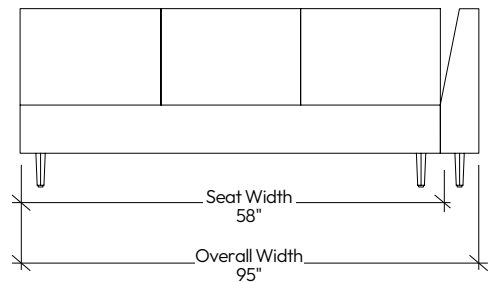

LK48 Genel Lounge, Three-Seater, Right Side Facing (IKNK3R)
front view

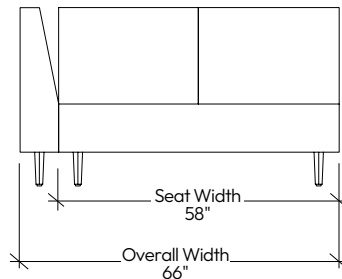

LK48 Genel Lounge, Two-Seater, Left Side Facing (IKNK2L)
front view

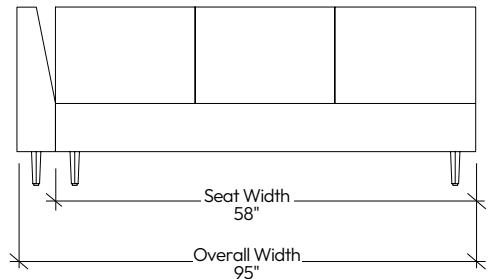

LK48 Genel Lounge, Three-Seater, Left Side Facing (IKNK3L)
front view

LK48 GENEL continued

DIMENSIONS (CONTINUED)

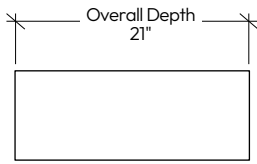

**LK48 Genel Cushion
(IKNM)**
side view

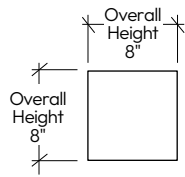

**LK48 Genel Cushion
(IKNM)**
front view

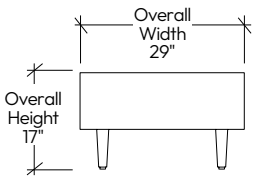

**LK48 Genel Bench
(IKNP)**
side view

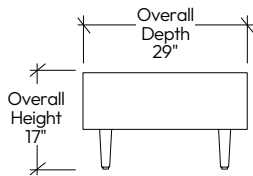

**LK48 Genel Bench
(IKNP)**
front view

LK48 GENEL continued

ELECTRICAL POSITIONING

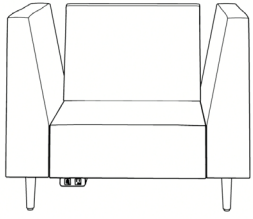

One-Seater: Left-Oriented
(from front)

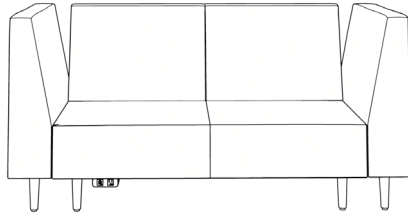

Two-Seater: Right or Left-Oriented
(from front)

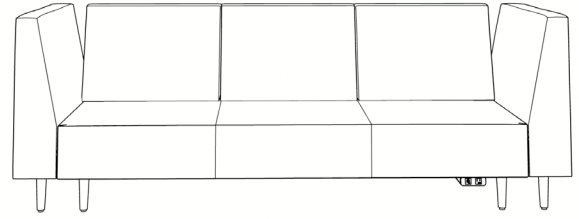

Three-Seater: Right or Left-Oriented
(from front)

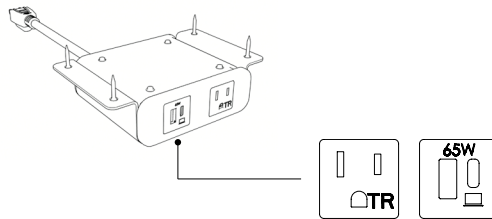

ELECTRICAL MODULE LOCATION

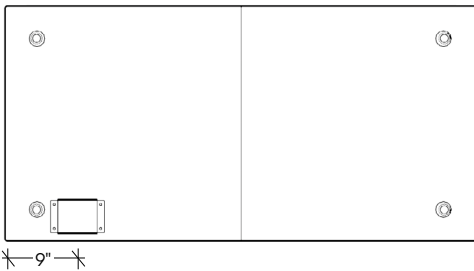

Electrical module is located 9" from the edge if there is no arm.

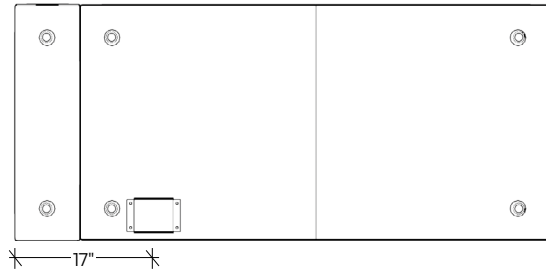

With the arm, electrical module is located 17" from the edge.

GANGING KIT INSTALLATION

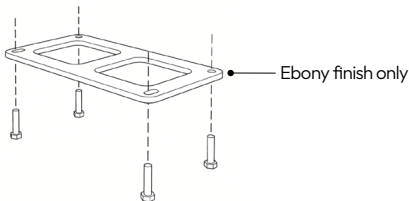

Ganging Kit (IKNS) connects two adjacent lounge seating or benches.

The total length of any ganged configuration must not exceed 26'.

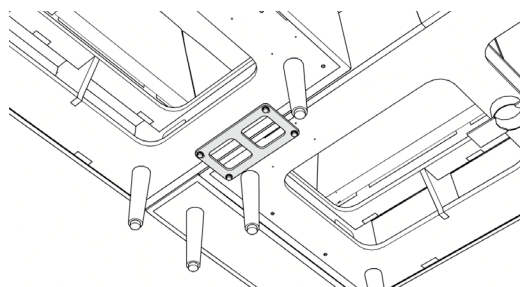

Threaded inserts are provided underneath each module for both parallel and perpendicular ganging.

Use the four bolts supplied with the ganging plate.

LK48 GENEL continued

FABRIC PATTERN AND SEAM GUIDELINES

Fabric

- Fabric is applied "Off-the-Bolt" which describes the orientation that fabric is applied to seating
- Seams are required at the center-line of three-seater straight upholstered benches and sofas (as indicated below)
- Patterned upholstery can be used
- COMs follow the same fabric orientation and pattern seaming

Leather

- Leather hides have variations in shape and limited dimensions
- Leather hides are divided into smaller panel sizes (approximately 14" x 11") and require additional seams
- Seams are required at the center-line of two-seater and three-seater straight upholstered benches and sofas (as indicated below)
- COLs follow the same fabric orientation and pattern seaming

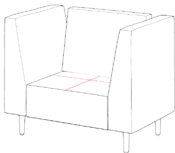
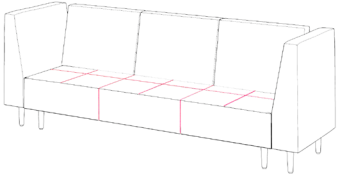
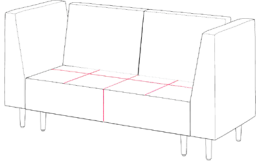
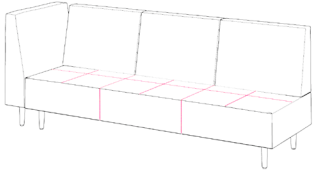
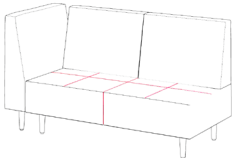
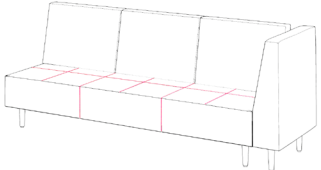
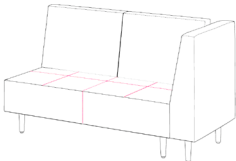
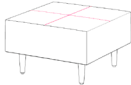
PRODUCT	LEATHER PATTERN SEAMS	PRODUCT	LEATHER PATTERN SEAMS
LK48 Genel Chair Sofa (IKNL)		LK48 Genel Lounge, Three-Seater, Right and Left Side Facing (IKNK3B)	
LK48 Genel Lounge, Two-Seater, Right and Left Side Facing (IKNK2B)		LK48 Genel Lounge, Three-Seater, Left Side Facing (IKNK3L)	
LK48 Genel Lounge, Two-Seater, Left Side Facing (IKNK2BL)		LK48 Genel Lounge, Three-Seater, Right Side Facing (IKNK3R)	
LK48 Genel Lounge, Two-Seater, Right Side Facing (IKNK2BR)		LK48 Genel Bench (IKNP)	

LK48 GENEL continued

DESIGNER TAG PLACEMENT

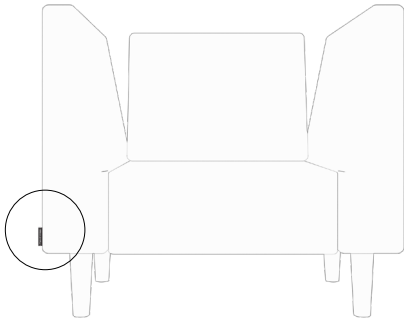

LK48 Genel Chair Sofa (IKNL)

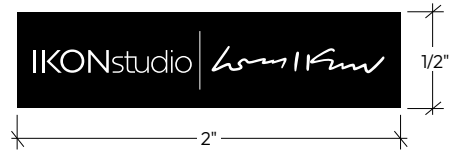

Orientation: Horizontal

Placement: Arm Bolster (if available)

Handedness: Left Arm Bolster (if available) as viewed from the back

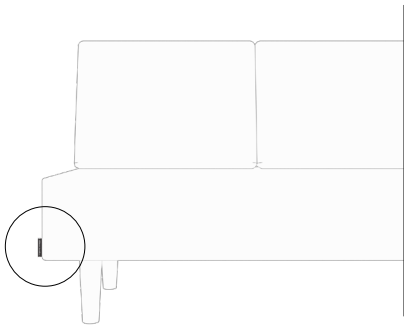

LK48 Genel Lounge Two-Seater and Three-Seater (IKNK)



LK48 Genel Cushion (IKNM)

LK48 GENEL continued

SPECIFYING FINISHES

- ① **Back & Arm Upholstery Finish (if applicable)**
Select the back and arm upholstery finish
- ② **Seat Upholstery Finish**
Select the seat upholstery finish
- ③ **Wood Leg Finish**
Select the wood leg finish
- ④ **Below Power Finish (if applicable)**
Select the below power finish

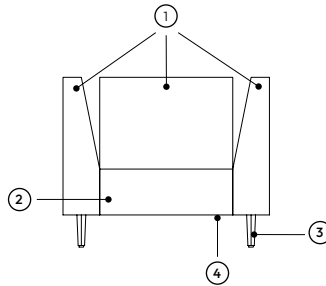

SPECIFICATION EXAMPLE

Below are the steps required to specify the LK48 Genel:

- 1. Select the lounge style
- 2. Select the size (if applicable)
- 3. Select the arm bolster orientation (if applicable)
- 3. Select the electrical option
- 4. Select the electrical position (if applicable)
- 5. Select the back and arm upholstery finish
- 4. Select the seat upholstery finish
- 5. Select the wood leg finish
- 6. Select the below power finish

EXAMPLE

IKNK

IKNK2

IKNK2R

IKNK2RP

IKNK2RPR

IKNK2RPRE504

IKNK2RPRE504E504

IKNK2RPRE504E504DV

IKNK2RPRE504E504DV68

LK48 GENEL CHAIR SOFA (IKNL)

PRODUCT DETAILS

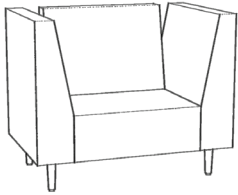

PRODUCT OPTIONS

ELECTRICAL OPTION	N No Power P One Below Power Module
BACK & ARM BOLSTER UPHOLSTERY FINISH	Fabric, Leather
SEAT UPHOLSTERY FINISH	Fabric, Leather
LEG FINISH	IKON Wood Veneer Stain Coordinates
BELOW POWER FINISH	Fundamental Paint Fashion Paint IKON Electrical Accessories Finish

PRICING

BACK & ARM BOLSTER UPHOLSTERY FINISH

ELECTRICAL OPTION	COM	COL	Grade 1	Grade 2	Grade 3	Grade 4	Grade 5	Grade 6	Grade 7	Grade 8	Grade 9	Grade 10	Leather LB	Leather LC	Leather LD
No Power (N)	7452	8197	7725	7846	7954	8074	8165	8241	8317	8408	8499	8590	9837	10655	10927
One Below Power Module (P)	7918	8663	8191	8312	8420	8540	8631	8707	8783	8874	8965	9056	10303	11121	11393

SEAT UPHOLSTERY FINISH

ELECTRICAL OPTION	COM	COL	Grade 1	Grade 2	Grade 3	Grade 4	Grade 5	Grade 6	Grade 7	Grade 8	Grade 9	Grade 10	Leather LB	Leather LC	Leather LD
No Power (N)	0	0	147	212	269	334	383	424	464	513	562	611	880	1320	1466
One Below Power Module (P)	0	0	147	212	269	334	383	424	464	513	562	611	880	1320	1466

LK48 GENEL LOUNGE (IKNK)

PRODUCT DETAILS

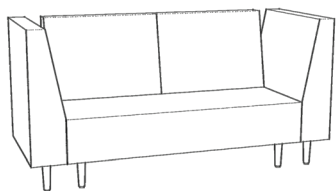

Two-Seater

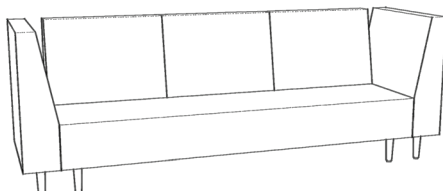

Three-Seater

PRODUCT OPTIONS

SIZE	2 Two-Seater 3 Three-Seater
ARM BOLSTER ORIENTATION	R Right Side Facing L Left Side Facing B Right and Left Side Facing
ELECTRICAL OPTION	N No Power P One Below Power Module
ELECTRICAL POSITION	N No Power R Right Side Facing L Left Side Facing
BACK & ARM BOLSTER UPHOLSTERY FINISH	Fabric, Leather
SEAT UPHOLSTERY FINISH	Fabric, Leather
LEG FINISH	IKON Wood Veneer Stain Coordinates
BELOW POWER FINISH	Fundamental Paint Fashion Paint IKON Electrical Accessories Finish

Pricing on the next page.

LK48 GENEL LOUNGE (IKNK) continued

PRICING

ELECTRICAL POSITION: NO POWER (N)

ELECTRICAL OPTION: NO POWER (N)															
TWO-SEATER															
Back & Arm Bolster Upholstery Finish															
ARM BOLSTER ORIENTATION	COM	COL	Grade 1	Grade 2	Grade 3	Grade 4	Grade 5	Grade 6	Grade 7	Grade 8	Grade 9	Grade 10	Leather LB	Leather LC	Leather LD
Right Side Facing (R)	8270	9097	8548	8672	8780	8904	8996	9073	9150	9244	9336	9429	10767	11601	11878
Left Side Facing (L)	8270	9097	8548	8672	8780	8904	8996	9073	9150	9244	9336	9429	10767	11601	11878
Right and Left Side Facing (B)	9271	10198	9671	9848	10003	10181	10314	10425	10536	10670	10803	10936	12596	13794	14192
Seat Upholstery Finish															
ARM BOLSTER ORIENTATION	COM	COL	Grade 1	Grade 2	Grade 3	Grade 4	Grade 5	Grade 6	Grade 7	Grade 8	Grade 9	Grade 10	Leather LB	Leather LC	Leather LD
Right Side Facing (R)	0	0	197	285	362	449	515	570	625	690	756	822	1184	1775	1972
Left Side Facing (L)	0	0	197	285	362	449	515	570	625	690	756	822	1184	1775	1972
Right and Left Side Facing (B)	0	0	197	285	362	449	515	570	625	690	756	822	1184	1775	1972
THREE-SEATER															
Back & Arm Bolster Upholstery Finish															
ARM BOLSTER ORIENTATION	COM	COL	Grade 1	Grade 2	Grade 3	Grade 4	Grade 5	Grade 6	Grade 7	Grade 8	Grade 9	Grade 10	Leather LB	Leather LC	Leather LD
Right Side Facing (R)	10319	11351	10734	10919	11081	11266	11405	11520	11635	11775	11913	12051	13846	15093	15507
Left Side Facing (L)	10319	11351	10734	10919	11081	11266	11405	11520	11635	11775	11913	12051	13846	15093	15507
Right and Left Side Facing (B)	11419	12561	11956	12195	12404	12643	12822	12971	13119	13299	13478	13657	15785	17396	17931
Seat Upholstery Finish															
ARM BOLSTER ORIENTATION	COM	COL	Grade 1	Grade 2	Grade 3	Grade 4	Grade 5	Grade 6	Grade 7	Grade 8	Grade 9	Grade 10	Leather LB	Leather LC	Leather LD
Right Side Facing (R)	0	0	237	342	434	539	618	684	750	828	907	986	1421	2130	2366
Left Side Facing (L)	0	0	237	342	434	539	618	684	750	828	907	986	1421	2130	2366
Right and Left Side Facing (B)	0	0	237	342	434	539	618	684	750	828	907	986	1421	2130	2366

Additional pricing on the next page.

LK48 GENEL LOUNGE (IKNK) continued

PRICING

ELECTRICAL POSITION: RIGHT SIDE FACING (R) OR LEFT SIDE FACING (L)

ELECTRICAL OPTION: ONE POWER BELOW MODULE (P)															
TWO-SEATER															
Back & Arm Bolster Upholstery Finish															
ARM BOLSTER ORIENTATION	COM	COL	Grade 1	Grade 2	Grade 3	Grade 4	Grade 5	Grade 6	Grade 7	Grade 8	Grade 9	Grade 10	Leather LB	Leather LC	Leather LD
Right Side Facing (R)	8736	9563	9014	9138	9246	9370	9462	9539	9616	9710	9802	9895	11233	12067	12344
Left Side Facing (L)	8736	9563	9014	9138	9246	9370	9462	9539	9616	9710	9802	9895	11233	12067	12344
Right and Left Side Facing (B)	9737	10664	10137	10314	10469	10647	10780	10891	11002	11136	11269	11402	13062	14260	14658
Seat Upholstery Finish															
ARM BOLSTER ORIENTATION	COM	COL	Grade 1	Grade 2	Grade 3	Grade 4	Grade 5	Grade 6	Grade 7	Grade 8	Grade 9	Grade 10	Leather LB	Leather LC	Leather LD
Right Side Facing (R)	0	0	197	285	362	449	515	570	625	690	756	822	1184	1775	1972
Left Side Facing (L)	0	0	197	285	362	449	515	570	625	690	756	822	1184	1775	1972
Right and Left Side Facing (B)	0	0	197	285	362	449	515	570	625	690	756	822	1184	1775	1972
THREE-SEATER															
Back & Arm Bolster Upholstery Finish															
ARM BOLSTER ORIENTATION	COM	COL	Grade 1	Grade 2	Grade 3	Grade 4	Grade 5	Grade 6	Grade 7	Grade 8	Grade 9	Grade 10	Leather LB	Leather LC	Leather LD
Right Side Facing (R)	10785	11817	11200	11385	11547	11732	11871	11986	12101	12241	12379	12517	14312	15559	15973
Left Side Facing (L)	10785	11817	11200	11385	11547	11732	11871	11986	12101	12241	12379	12517	14312	15559	15973
Right and Left Side Facing (B)	11885	13027	12422	12661	12870	13109	13288	13437	13585	13765	13944	14123	16251	17862	18397
Seat Upholstery Finish															
ARM BOLSTER ORIENTATION	COM	COL	Grade 1	Grade 2	Grade 3	Grade 4	Grade 5	Grade 6	Grade 7	Grade 8	Grade 9	Grade 10	Leather LB	Leather LC	Leather LD
Right Side Facing (R)	0	0	237	342	434	539	618	684	750	828	907	986	1421	2130	2366
Left Side Facing (L)	0	0	237	342	434	539	618	684	750	828	907	986	1421	2130	2366
Right and Left Side Facing (B)	0	0	237	342	434	539	618	684	750	828	907	986	1421	2130	2366

LK48 GENEL CUSHION (IKNM)

PRODUCT DETAILS

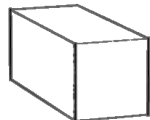

PRODUCT OPTIONS

SIZE S Single Rectangular

UPHOLSTERY FINISH Fabric, Leather

PRICING

UPHOLSTERY FINISH

COM	COL	Grade 1	Grade 2	Grade 3	Grade 4	Grade 5	Grade 6	Grade 7	Grade 8	Grade 9	Grade 10	Leather LB	Leather LC	Leather LD
550	605	611	638	661	688	708	725	742	762	783	803	969	1151	1212

LK48 GENEL BENCH (IKNP)

PRODUCT DETAILS

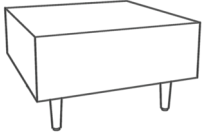

PRODUCT OPTIONS

SIZE	S Single
UPHOLSTERY FINISH	Fabric, Leather
LEG FINISH	IKON Wood Veneer Stain Coordinates

PRICING

UPHOLSTERY FINISH														
COM	COL	Grade 1	Grade 2	Grade 3	Grade 4	Grade 5	Grade 6	Grade 7	Grade 8	Grade 9	Grade 10	Leather LB	Leather LC	Leather LD
2537	2791	2674	2734	2787	2848	2894	2932	2969	3015	3060	3106	3611	4020	4156

LK48 GENEL GANGING KIT (IKNS)

PRODUCT DETAILS



PRODUCT OPTIONS

GANGING KIT
CONFIGURATION L Linear

PRICING

BASE PRICE

82
