

worksurfaces & countertops

PRODUCT MAP	154
WORKSURFACE & COUNTERTOP BASICS	157
GROMMET & MONOLEG STYLES	158
KEYBOARD SUPPORT SURFACES	159
EDGE TRIM STYLE OVERVIEW	160
GRAIN DIRECTION/USER EDGE	161
PRODUCT LISTING	162

product map

W S Rectangular Worksurface

Page 162
Depth: 20" – 30" / Width: 24" – 96"

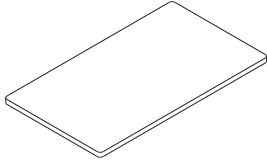

W P S 90° Corner Worksurface

Page 164
Width: 36" – 48" / Depth: 19" – 30"

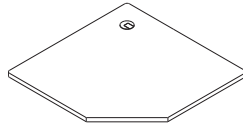

W S C X 90° Split Corner Worksurface with Curved Keyboard Support

Page 165
Width: 42" & 48" / Depth: 24" & 30"

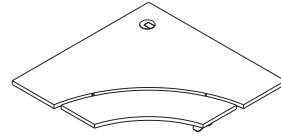

W P S X 90° Split Corner Worksurface with Keyboard Support

Page 166
Width: 42" & 48" / Depth: 24" & 30"

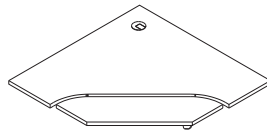

W S C 90° Corner Worksurface with Curve

Page 168
Width: 30" – 60" / Depth: 19" – 30"

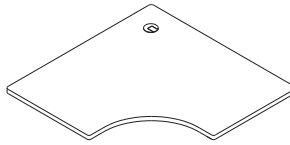

W E R C 90° Extended Radius Corner Worksurface

Page 170
Depth: 24" & 30" / Width: 36" – 96"

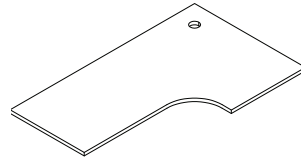

W F S 120° Corner Worksurface

Page 172
Width: 30" & 36" / Depth: 24" & 30"

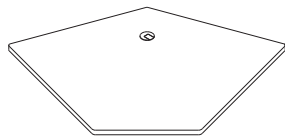

W D EDP Worksurface – Straight & Curved

Page 174
Width: 24" – 84" / Depth: 19" – 30"

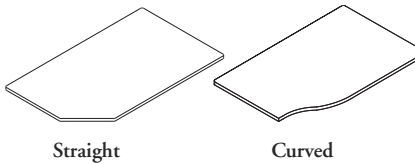

W R Outside Corner Worksurface

Page 176
Depth: 24" & 30"

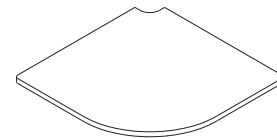

W S R Bullet Top

Page 177
Depth: 24" – 36" / Width: 48" – 72"

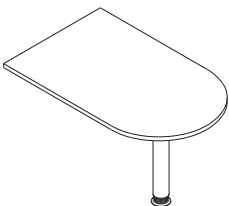

W S N Piano Top

Page 178
Depth: 24" & 30" / Width: 60" – 84"

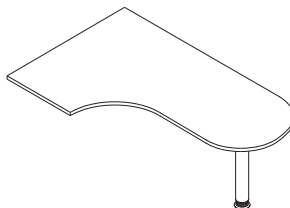

W S D D-Top

Page 179
Depth: 24" & 30"

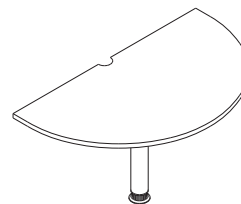

W S T Straight Transition Worksurface

Page 180
Width: 30" – 72" / Depth: 20" – 30"

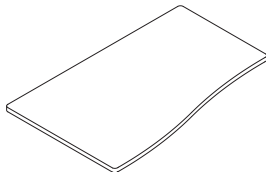

W S T R Transition Corner Worksurface with Return

Page 181
Depth: 20" & 24" / Width: 36" – 72"

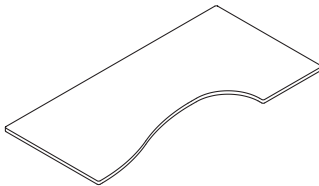

W C Rectangular Countertop

Page 182
Depth: 15" / Width: 24" – 72"

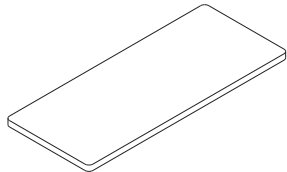

W C Bullet Countertops

Page 183
Depth: 15" / Width: 24" – 72"

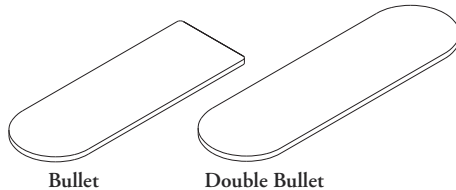

W C C 9 0 90° Curved Countertop

Page 184
Depth: 15" / Width: 24" – 72"

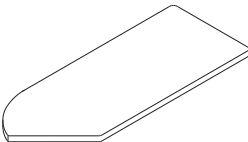

worksurface & countertop basics

Worksurfaces and countertops are panel-mounted and designed for use with all T/O/S panel types.

- ❗ Worksurfaces may not span more than 60" without additional support
- Can be panel-mounted on- or off-module
- Worksurface support hardware must be ordered separately
- If the countertop specified is wider than 36", it is possible for it to span two panels (e.g. one 72" wide countertop over two 36" wide connected panels)

- **120° Corner Worksurfaces** are designed for use in 120° corners
- The straight edge is ideal for mounting a keyboard support
- Can be mounted on- or off-module
- One grommet is included at the back corner of the worksurface

- **Straight Worksurfaces** include Rectangular, EDP (straight and curved), Straight Transition and Outside Corner Worksurfaces
- Are panel-mounted and provide a primary or secondary surface
- Can be used on- or off-module when suspended from a panel, except on the Outside Corner Worksurface, which is on-module only
- Grommets (if applicable) can be ordered at time of purchase or subsequently
- EDP surface can be specified with either a straight or curved profile to work in conjunction with a Standard Corner Surface

- **Extended Corner Worksurfaces** combine a rectangular and corner worksurface to provide one continuous surface
- Can be mounted on- or off-module
- Can be specified with different widths at either end
- Can be specified with a grommet on the back corner

- **Countertops** can be used alone or together with other counter top types to create transaction surfaces and fit any T/O/S panel
- Top Trim (Metal or Flintwood) of the panel to which the countertop is being mounted must be specified so that proper support brackets can be supplied
- Overlap the panel by 7" on either side, and should be specified the same width as the panel

- **Guesting Worksurfaces** include the Bullet Top, Piano Top and D-Top
- All except are semi-suspended and must mount at one end to a panel or other worksurface
- All include support legs

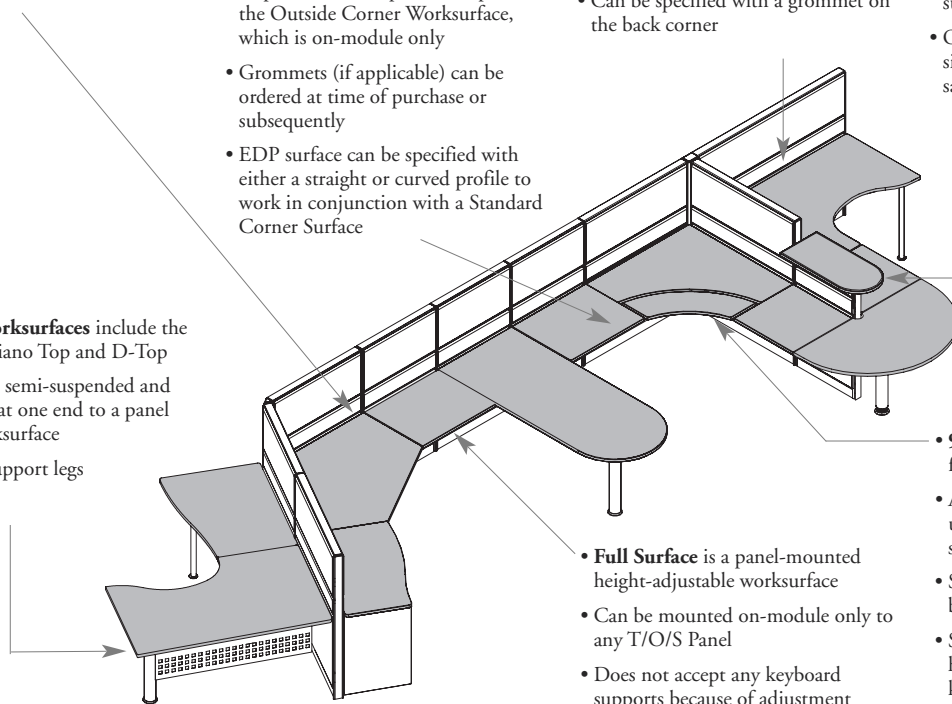

- **Full Surface** is a panel-mounted height-adjustable worksurface
- Can be mounted on-module only to any T/O/S Panel
- Does not accept any keyboard supports because of adjustment mechanism

- **90° Corner Worksurfaces** designed for use in 90° corners
- Available with straight or curved user edges which will support a separate keyboard
- Standard with one grommet at the back corner of the worksurface
- Surfaces with keyboard cut-outs have a 1" gap surrounding the keyboard surface

- **Seamless Finish Worksurface** widths greater than 48" will be accompanied by an adjustable support beam
- Support beam can be fitted to the left or right when applying pedestal storage underneath
- Accept Keyboard Trays and Accessories
- With a support beam must include a Spacer Bracket. Please see Complements: *Teknion's Ergonomics & Accessories Program*
- With a support beam will **not** accept Pelican Drawers (DPD21, DPD61)
- Will not accept Stretch Pedestals or Two-High Laterals with worksurfaces greater than 48" in width

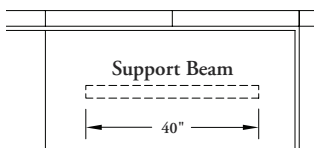
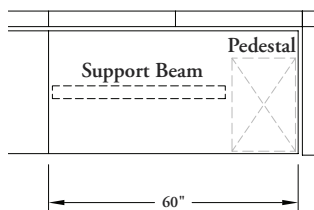

Finishes

- Worksurfaces are available in Foundation Laminate, Flintwood stains and Seamless Colors
- Edge trim styles include Slim, Bullnose, Straight, Flintwood Straight, Flintwood Slim, Seamless Knife, Seamless Flat and Seamless Eased
- Flintwood and Seamless edge trims will be finished to match the surface
- Supports, when included are available in Foundation, Mica and Accent colors
- Not all finishes are available on every worksurface. Please see individual product pages for details

grommet & monoleg styles

The following illustrates the grommet locations offered on T/O/S worksurfaces.

! The following restrictions apply when using seamless worksurfaces

grommet styles

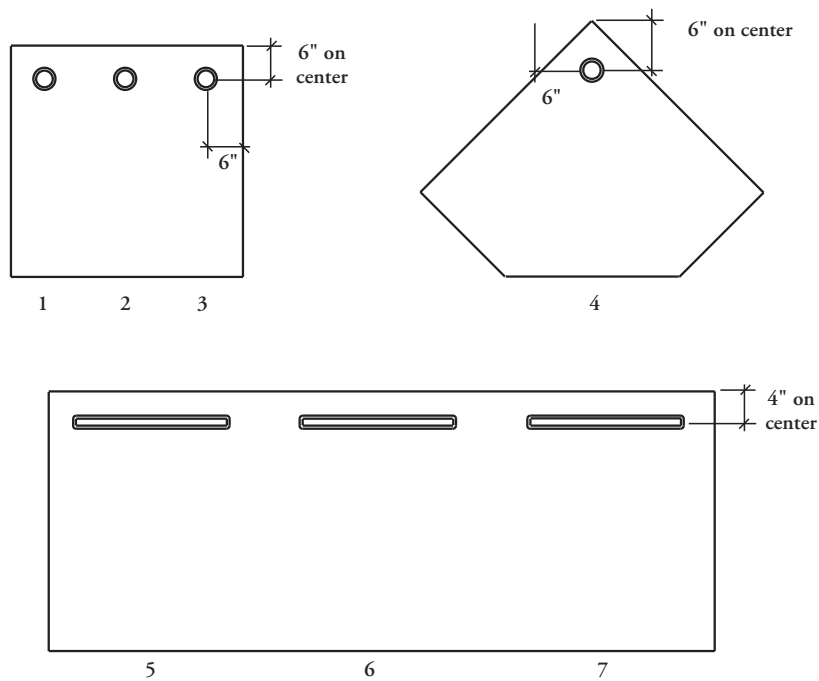

grommet locations

- 1 Wire Left
- 2 Wire Center
- 3 Wire Right
- 4 Wire Five-Sided Corner
- 5 Paper Left
- 6 Paper Center
- 7 Paper Right

worksurfaces & countertops

keyboard support surfaces

90° Split Corner Worksurfaces with Keyboard Support provide a wide tray and mouse-support solution in panel-mounted environments.

- ❗ Must be panel-mounted using Handed Cantilevers (CT) with panels on both sides
- Can be panel-mounted at 1" increments in height. The surface has a secondary adjustable keyboard surface that adjusts independently in height and tilt

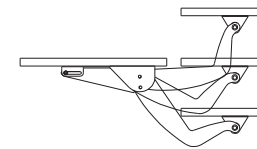
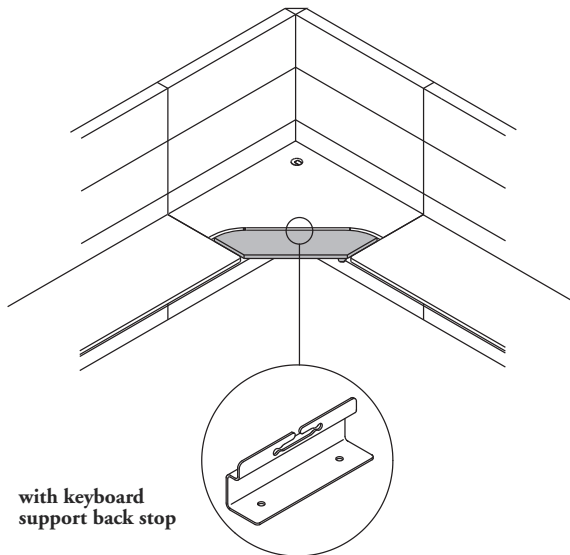

90° Split Corner Worksurface with Curved Keyboard Support (WSCX)

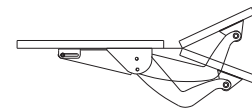

90° Split Corner Worksurface with Keyboard Support (WPSX)

All split corner worksurfaces with keyboard support include a keyboard support backstop which prevents keyboards from sliding off the worksurface when placed in its negative tilt position

keyboard support adjustment mechanism

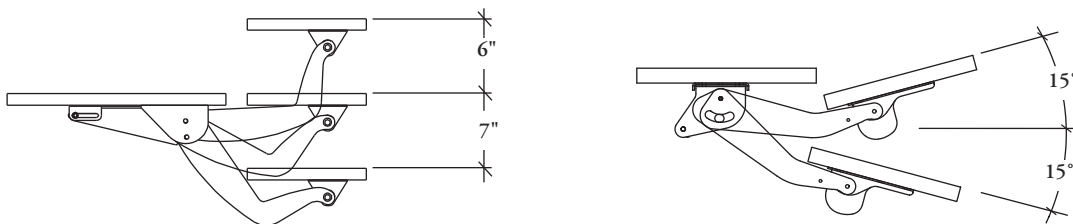









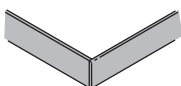

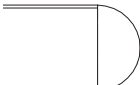
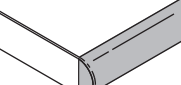

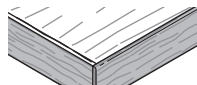

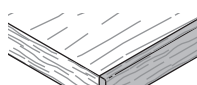
- The standard keyboard height adjustment range is, 13" overall (7" above the worksurface and 6" below the worksurface)
- Height adjustment is activated by a release paddle located on the right underside of the support the tilt adjustment range is +15° to -15°
- It is adjusted with a tension knob located on the underside of the support

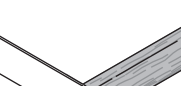
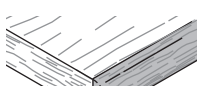
edge trim style overview

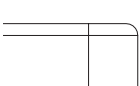
The chart below indicates which edge trim can be specified with all T/O/S worksurfaces.

! Shading indicates user edge

		Foundation Laminate Surface	Seamless Color Surface	Flintwood Surface	Non-User Edge
Straight (6)			n/a	n/a	Straight (6)
All Edges					
Slim (1)			n/a	n/a	Slim (1)
All Edges					
Bullnose (2)			n/a	n/a	Finished to coordinate with the worksurface
User Edge Only					
Flintwood Straight (7)		n/a	n/a		Flintwood Straight (7)
All Edges					
Flintwood Slim (4)		n/a	n/a		Finished to coordinate with the worksurface
User Edge Only					
Flintwood Bullnose (3)			n/a		Finished to coordinate with the worksurface
User Edge Only					
Seamless Knife (K)		n/a		n/a	Finished in a coordinating flat trim
User Edge Only					
Seamless Flat (G)		n/a		n/a	Seamless Flat (G)
All Edges					
Seamless Eased (E)		n/a		n/a	Finished in a coordinating flat trim
User Edge Only					

The illustrations below show the grain direction of Laminate worksurfaces.

- Grain direction is an important factor when planning workstation configurations, if a different grain direction is required, please contact your Teknion Customer Service Representative
- The pattern/grain direction of Laminate and worksurfaces varies depending on the type of worksurface specified
- Shading indicates user edge



Rectangular Worksurface (WS)



Straight Transition Worksurface (WST)



EDP Worksurface Straight & Curved (WST)



90° Corner Worksurface (WPS)



90° Split Corner Worksurface with Curved Keyboard Support (WSCX)



90° Split Worksurface with Keyboard Support (WPSX)



90° Corner Worksurface with Curve (WSC) (Grain Direction dependent on width specified. See price guide)



90° Extended Radius Corner Worksurface (WERC)



120° Corner Worksurface (WFS)



Outside Corner Worksurface (WR)



Bullet Top (WSR)



Piano Top (WSN)



Transition Corner Worksurface with Return (WSTR)



D-Top (WSD)



Rectangular Countertop (WC)



Bullet Countertops (WC)



90° Curved Countertop (WCC90)